

## Excellent Integrated System Limited

Stocking Distributor

Click to view price, real time Inventory, Delivery & Lifecycle Information:

[Bourns Inc.](#)  
[CDNBS08-PLC03-3.3](#)

For any questions, you can email us directly:  
[sales@integrated-circuit.com](mailto:sales@integrated-circuit.com)



### Features

- RoHS compliant\*
- Telcordia GR1089 (Intra-Building)
- Protects 2 lines
- ESD protection >40 kV
- Low capacitance 8 pF

### Applications

- T1/E1 line cards
- ISDN U-Interface and S/T Interface
- xDSL
- Ethernet – 10/100 Base T

## CDNBS08-PLC03-3.3 Steering Diode/TVS Array Combo

### General Information

The markets of portable communications, computing and video equipment are challenging the semiconductor industry to develop increasingly smaller electronic components.

Bourns offers Steering Diode/Transient Voltage Suppressor Array combination diodes for surge and ESD protection applications in an eight lead Narrow Body SOIC package size format.

The Bourns® device will meet IEC 61000-4-2 (ESD), IEC 61000-4-4 (EFT) and IEC 61000-4-5 (Surge) requirements.

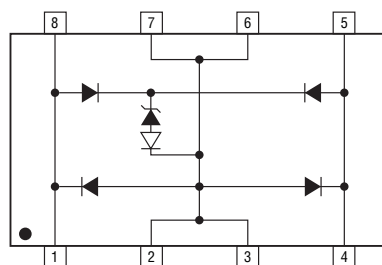

### Electrical Characteristics (@ T<sub>A</sub> = 25 °C Unless Otherwise Noted)

Parameter	Symbol	Min.	Nom.	Max.	Unit
Capacitance @ 0 V 1 MHz <sup>1</sup>	C <sub>J(SD)</sub>		20	25	pF
Capacitance @ 0 V 1 MHz <sup>2</sup>	C <sub>J(SD)</sub>		8	12	pF
Working Peak Voltage	V <sub>WM</sub>			3.0	V
Min. Breakdown Voltage @ 1 mA	V <sub>BR</sub>	3.3			V
Clamping Voltage @ 8/20 μs @ IPP = 100 A <sup>3,4</sup>	V <sub>F</sub>			18	V
Clamping Voltage @ 8/20 μs @ IP = 50 A, Line - Ground	V <sub>F</sub>			11	V
Max. Leakage Current @ V <sub>WM</sub>	I <sub>D</sub>			2	μA
ESD Protection: IEC 61000-4-2 Contact Discharge Air Discharge		±8 ±15			kV kV
Peak Pulse Power (tp = 8/20 μs) <sup>5</sup>	P <sub>PP</sub>			1800	W
EFT Protection: IEC61000-4-4 @ 5/50 ns		40			A
Surge Protection: IEC61000-4-5 @ 8/20 μs L4 (Line-Gnd) L4 (Line-Line) , L1 (Power)		94 48			A A
Surge Protection: Telcordia GR1089 (Intra-Building) @ 2/10 μs		100			A

#### Notes:

1. Measured between I/O pins and ground (pin 1 or 2).
2. Measured between I/O pins (pins 1 to 4).
3. See Pulse Wave Form. For an 8/20 μs waveform, apply positive pulse to pin 1 to 8 to pin 2 or 3 (ground).
4. Measured between pin 1 or 8 to pin 2 or 3; pin 1 or 8 to pin 4 or 5.
5. See Peak Pulse Power vs. Pulse Time.

### Thermal Characteristics (@ T<sub>A</sub> = 25 °C Unless Otherwise Noted)

Parameter	Symbol	Min.	Nom.	Max.	Unit
Junction Temperature Range	T <sub>J</sub>	-55	+25	+150	°C
Storage Temperature Range	T <sub>STG</sub>	-55	+25	+150	°C

\*RoHS Directive 2002/95/EC Jan 27, 2003 including Annex.  
 Specifications are subject to change without notice.  
 Customers should verify actual device performance in their specific applications.

## CDNBS08-PLC03-3.3 Steering Diode/TVS Array Combo



### Mechanical Characteristics

This is an RoHS compliant molded JEDEC Narrow Body SO-8 package with 100 % Sn plating on the lead frame. It weighs approximately 15 mg and has a flammability rating of UL 94V-0.

### Product Dimensions

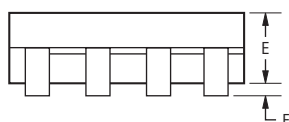
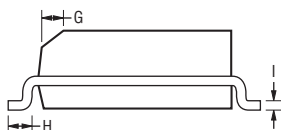
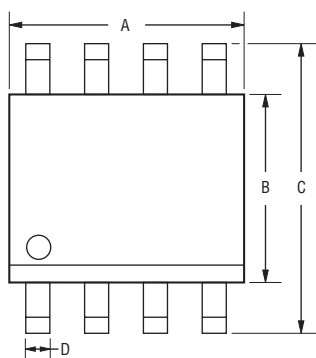

DIMENSIONS =  $\frac{\text{MILLIMETERS}}{\text{(INCHES)}}$

Dimensions	
A	$\frac{4.80 - 5.00}{(0.189 - 0.196)}$
B	$\frac{3.80 - 4.00}{(0.150 - 0.157)}$
C	$\frac{5.80 - 6.20}{(0.229 - 0.244)}$
D	$\frac{0.36 - 0.46}{(0.014 - 0.018)}$
E	$\frac{1.35 - 1.75}{(0.054 - 0.068)}$
F	$\frac{0.10 - 0.25}{(0.004 - 0.008)}$
G	$\frac{0.25 - 0.50}{(0.010 - 0.019)}$
H	$\frac{0.40 - 1.250}{(0.016 - 0.049)}$
I	$\frac{0.18 - 0.25}{(0.007 - 0.009)}$

### Recommended Footprint

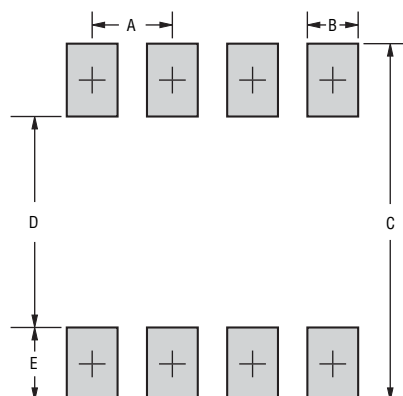

Dimensions	
A	$\frac{1.143 - 1.397}{(0.045 - 0.055)}$
B	$\frac{0.635 - 0.889}{(0.025 - 0.035)}$
C	$\frac{6.223}{(0.245)}$ Min.
D	$\frac{3.937 - 4.191}{(0.155 - 0.165)}$
E	$\frac{1.016 - 1.27}{(0.040 - 0.050)}$

### How To Order

**CD NBS08 - PLC03 - 3.3**

Common Code \_\_\_\_\_  
 CD = Chip Diode

Package \_\_\_\_\_  
 NBS08 = Narrow Body SOIC8 Package

Model \_\_\_\_\_  
 PLC03 = Model Number

Minimum Breakdown Voltage \_\_\_\_\_  
 3.3 = 3.3 V<sub>BR</sub> (Volts)

### Typical Part Marking

CDNBS08-PLC03-3.3 ..... PBC

## CDNBS08-PLC03-3.3 Steering Diode/TVS Array Combo

### Block Diagram

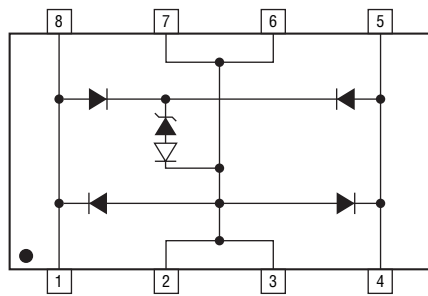

### Device Pinout

Pin	Function
1	I/O 1
2	GND
3	GND
4	I/O 2
5	I/O 2
6	GND
7	GND
8	I/O 1

### Performance Graphs

#### Peak Pulse Power vs Pulse Time

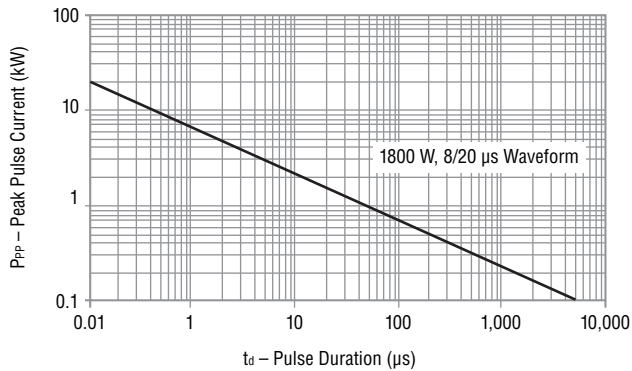

#### Pulse Wave Form

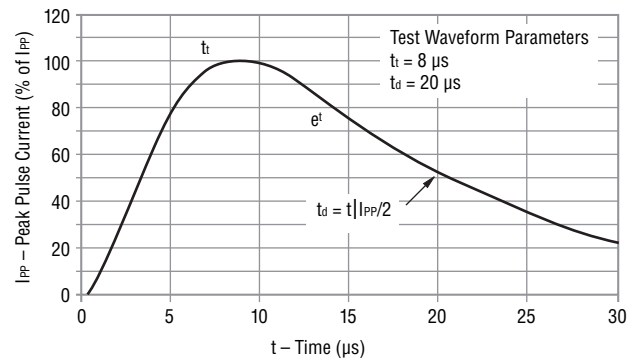

#### Power Derating Curve

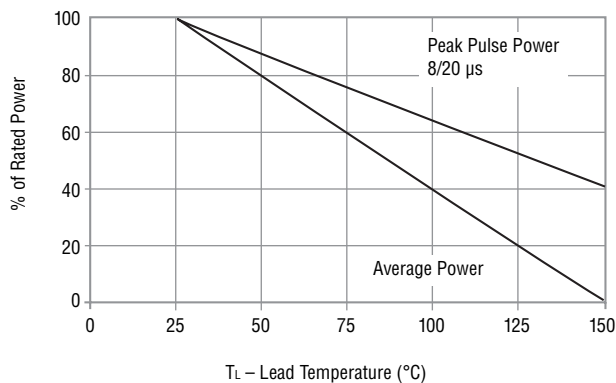

## CDNBS08-PLC03-3.3 Steering Diode/TVS Array Combo

### Packaging Specifications

The product will be dispensed in Tape and Reel format (see diagram below).

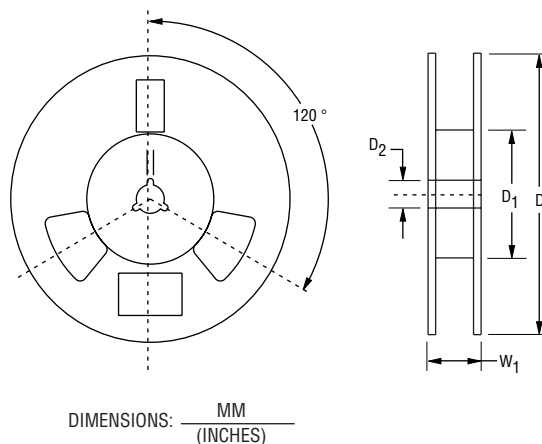
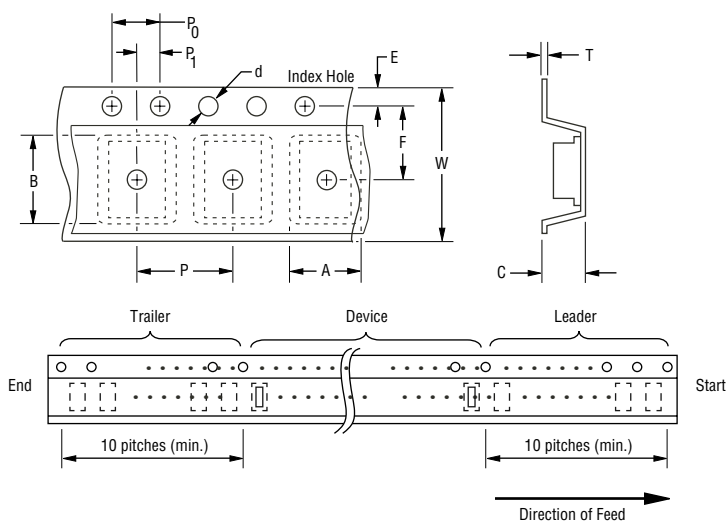

Devices are packed in accordance with EIA standard RS-481-A.

Item	Symbol	NSOIC 8L
Carrier Width	A	$\frac{6.7 \pm 0.10}{(0.264 \pm 0.004)}$
Carrier Length	B	$\frac{5.5 \pm 0.10}{0.217 \pm 0.004}$
Carrier Depth	C	$\frac{2.10 \pm 0.10}{0.083 \pm 0.004}$
Sprocket Hole	d	$\frac{1.55 \pm 0.05}{(0.061 \pm 0.002)}$
Reel Outside Diameter	D	$\frac{330}{(12.992)}$
Reel Inner Diameter	D <sub>1</sub>	$\frac{80.0}{(3.1500)}$ MIN.
Feed Hole Diameter	D <sub>2</sub>	$\frac{13.0 \pm 0.20}{(0.512 \pm 0.008)}$
Sprocket Hole Position	E	$\frac{1.75 \pm 0.10}{(0.069 \pm 0.004)}$
Punch Hole Position	F	$\frac{3.50 \pm 0.05}{(0.138 \pm 0.002)}$
Punch Hole Pitch	P	$\frac{8.00 \pm 0.10}{(0.315 \pm 0.004)}$
Sprocket Hole Pitch	P <sub>0</sub>	$\frac{4.00 \pm 0.10}{(0.157 \pm 0.004)}$
Embossment Center	P <sub>1</sub>	$\frac{2.00 \pm 0.05}{(0.079 \pm 0.002)}$
Overall Tape Thickness	T	$\frac{0.20 \pm 0.10}{(0.008 \pm 0.004)}$
Tape Width	W	$\frac{12.00 \pm 0.20}{(0.472 \pm 0.008)}$
Reel Width	W <sub>1</sub>	$\frac{18.4}{(0.724)}$ MAX.
Quantity per Reel	-	2500

REV. 06/11

Specifications are subject to change without notice.  
 Customers should verify actual device performance in their specific applications.

**Asia-Pacific:**  
 Tel: +886-2 2562-4117 • Fax: +886-2 2562-4116  
**Europe:**  
 Tel: +41-41 768 5555 • Fax: +41-41 768 5510  
**The Americas:**  
 Tel: +1-951 781-5500 • Fax: +1-951 781-5700  
[www.bourns.com](http://www.bourns.com)