

Excellent Integrated System Limited

Stocking Distributor

Click to view price, real time Inventory, Delivery & Lifecycle Information:

[Texas Instruments](#)
[TAS5176DDW](#)

For any questions, you can email us directly:

sales@integrated-circuit.com

6-Channel, 100-W, Digital-Amplifier Power Stage

FEATURES

- **Total Output Power at 10% THD+N**
 - 5 × 15 W at 8 Ω + 1 × 25 W at 4 Ω (Single-Ended)
 - 2 × 30 W at 8 Ω (BTL)
 - 1 × 40 W at 6 Ω (BTL)
- **105-dB SNR (A-Weighted), with TAS5086 Modulator**
- **< 0.05% THD+N at 1 W**
- **Power Stage Efficiency > 90% Into Recommended Loads (SE)**
- **Integrated Self-Protection Circuits**
 - Undervoltage
 - Overtemperature
 - Overload
 - Short Circuit
- **Integrated Active-Bias Control to Avoid DC Pop**
- **Footprint Compatible with the TAS5186A for Scalable Designs**
- **Thermally Enhanced 44-pin HTSSOP Package with PowerPad located on the bottom of the device**
- **EMI-Compliant When Used With Recommended System Design**

APPLICATIONS

- DVD Receiver
- Home Theater in a Box
- Televisions

DESCRIPTION

The TAS5176 is a high-performance, six-channel, digital-amplifier power stage with an improved protection system. The TAS5176 is capable of driving a 8-Ω, single-ended load up to 15 W per each front/satellite channel and a 4-Ω, single-ended subwoofer greater than 25 W at 10% THD+N performance.

Furthermore, the TAS5176 can drive three-channels in BTL mode, with the same high-performance but with a higher power level. In BTL mode, the TAS5176 is capable of driving 8-Ω loads to greater than 30 Watts at 10% THD+N performance.

A low-cost, high-fidelity audio system can be built using a TI chipset comprising a modulator (e.g., TAS5086) and the TAS5176. This device does not require power-up sequencing because of the internal power-on reset.

The TAS5176 requires only simple passive demodulation filters on its outputs to deliver high-quality, high-efficiency audio amplification. The efficiency of the TAS5176 is greater than 90% when driving 8-Ω satellites and a 4-Ω subwoofer speaker.

The TAS5176 has an innovative protection system integrated on-chip, safeguarding the device against a wide range of fault conditions that could damage the system. These safeguards are short-circuit protection, overload protection, undervoltage protection, and overtemperature protection. The TAS5176 has a new proprietary current-limiting circuit that reduces the possibility of device shutdown during high-level music transients. A new programmable overcurrent detector allows the use of lower-cost inductors in the demodulation output filter.

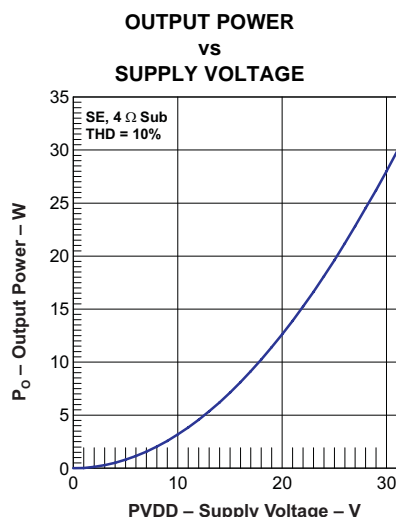

Please be aware that an important notice concerning availability, standard warranty, and use in critical applications of Texas Instruments semiconductor products and disclaimers thereto appears at the end of this data sheet.

PowerPAD, PurePath Digital are trademarks of Texas Instruments. All other trademarks are the property of their respective owners.

TAS5176



SLES196–JUNE 2007



These devices have limited built-in ESD protection. The leads should be shorted together or the device placed in conductive foam during storage or handling to prevent electrostatic damage to the MOS gates.

DEVICE INFORMATION

TERMINAL ASSIGNMENT

The TAS5176 is available in a thermally enhanced 44-pin HTSSOP PowerPAD™ package. The heat slug is located on the bottom side of the device for convenient thermal coupling to the printed circuit board which is used as the heatsink for this device.

**DDW PACKAGE
(TOP VIEW)**

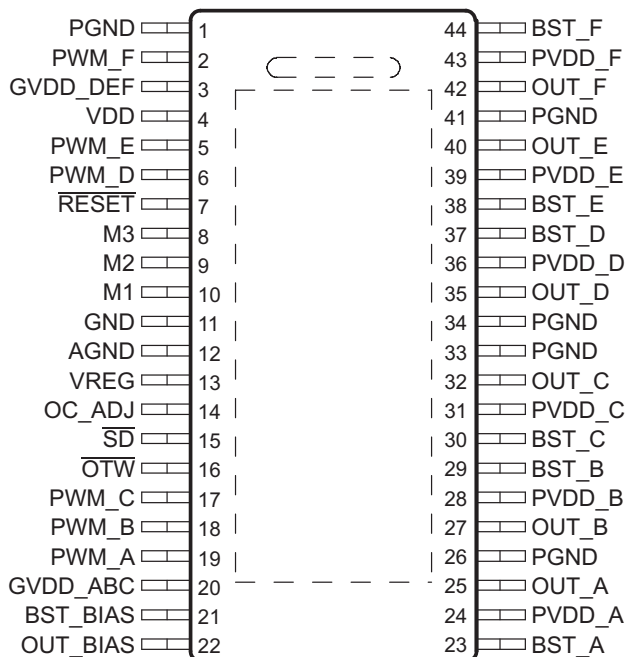

P0016-02

DEVICE INFORMATION (continued)
TERMINAL FUNCTIONS

TERMINAL		TYPE ⁽¹⁾	DESCRIPTION
NAME	NO.		
AGND	12	P	Analog ground
BST_A	23	P	HS bootstrap supply (BST), capacitor to OUT_A required
BST_B	29	P	HS bootstrap supply (BST), external capacitor to OUT_B required
BST_BIAS	21	P	BIAS bootstrap supply, external capacitor to OUT_BIAS required
BST_C	30	P	HS bootstrap supply (BST), external capacitor to OUT_C required
BST_D	37	P	HS bootstrap supply (BST), external capacitor to OUT_D required
BST_E	38	P	HS bootstrap supply (BST), external capacitor to OUT_E required
BST_F	44	P	HS bootstrap supply (BST), external capacitor to OUT_F required
GND	11	P	Chip ground
GVDD_ABC	20	P	Gate drive voltage supply
GVDD_DEF	3	P	Gate drive voltage supply
M1	10	I	Mode selection pin
M2	9	I	Mode selection pin
M3	8	I	Mode selection pin
OC_ADJ	14	O	Overcurrent threshold programming pin, resistor to AGND required
OTW	16	O	Overtemperature warning open-drain output signal, active-low
OUT_A	25	O	Output, half-bridge A, satellite
OUT_B	27	O	Output, half-bridge B, satellite
OUT_BIAS	22	O	BIAS half-bridge output pin
OUT_C	32	O	Output, half-bridge C, subwoofer
OUT_D	35	O	Output, half-bridge D, satellite
OUT_E	40	O	Output, half-bridge E, satellite
OUT_F	42	O	Output, half-bridge F, satellite
PGND	1, 26, 33, 34, 41	P	Power ground
PVDD_A	24	P	Power-supply input for half-bridge A
PVDD_B	28	P	Power-supply input for half-bridge B
PVDD_C	31	P	Power-supply input for half-bridge C
PVDD_D	36	P	Power-supply input for half-bridge D
PVDD_E	39	P	Power-supply input for half-bridge E
PVDD_F	43	P	Power-supply input for half-bridge F
PWM_A	19	I	PWM input signal for half-bridge A
PWM_B	18	I	PWM input signal for half-bridge B
PWM_C	17	I	PWM input signal for half-bridge C
PWM_D	6	I	PWM input signal for half-bridge D
PWM_E	5	I	PWM input signal for half-bridge E
PWM_F	2	I	PWM input signal for half-bridge F
RESET	7	I	Reset signal (active-low logic)
SD	15	O	Shutdown open-drain output signal, active-low
VDD	4	P	Power supply for digital voltage regulator
VREG	13	O	Digital regulator supply filter pin, output

(1) I = input; O = output; P = power

TAS5176

SLES196–JUNE 2007

Table 1. MODE Selection Pins

MODE PINS ⁽¹⁾		MODE	
M2	M3	NAME	DESCRIPTION
0	0	2.1 mode	Channels A, B, and C enabled; channels D, E, and F disabled
0	1	5.1 mode	All channels enabled
1	0	3.0 mode	BTL Mode
1	1	Reserved	

(1) M1 must always be connected to ground. 0 indicates a pin connected to GND; 1 indicates a pin connected to VREG.

PACKAGE HEAT DISSIPATION RATINGS⁽¹⁾

PARAMETER	TAS5176DDW
$R_{\theta JC}$ (°C/W)—1 satellite (sat.) FET only	10.3
$R_{\theta JC}$ (°C/W)—1 subwoofer (sub.) FET only	5.2
$R_{\theta JC}$ (°C/W)—1 sat. half-bridge	5.2
$R_{\theta JC}$ (°C/W)—1 sub. half-bridge	2.6
$R_{\theta JC}$ (°C/W)—5 sat. half-bridges + 1 sub.	1.74
Typical pad area ⁽²⁾	24.72 mm ²

(1) JC is junction-to-case, CH is case-to-heatsink.

(2) $R_{\theta CH}$ is an important consideration. Assume a 2-mil thickness of typical thermal grease between the pad area and the heatsink. The $R_{\theta CH}$ with this condition is typically 2°C/W for this package.

ABSOLUTE MAXIMUM RATINGS

over operating free-air temperature range (unless otherwise noted)⁽¹⁾

	UNITS
VDD to AGND	–0.3 V to 13.2 V
GVDD_X to AGND	–0.3 V to 13.2 V
PVDD_X to PGND_X ⁽²⁾	–0.3 V to 50 V
OUT_X to PGND_X ⁽²⁾	–0.3 V to 50 V
BST_X to PGND_X ⁽²⁾	–0.3 V to 63.2 V
VREG to AGND	–0.3 V to 4.2 V
PGND_X to GND	–0.3 V to 0.3 V
PGND_X to AGND	–0.3 V to 0.3 V
GND to AGND	–0.3 V to 0.3 V
PWM_X, OC_ADJ, M1, M2, M3 to AGND	–0.3 V to 4.2 V
RESET, \overline{SD} , \overline{OTW} to AGND	–0.3 V to 7 V
Maximum operating junction temperature range (T_J)	0 to 125°C
Storage temperature	–40°C to 125°C
Lead temperature – 1.6 mm (1/16 inch) from case for 10 seconds	260°C
Minimum PWM pulse duration, low	30 ns

(1) Stresses beyond those listed under *absolute maximum ratings* may cause permanent damage to the device. These are stress ratings only, and functional operation of the device at these or any other conditions beyond those indicated under *recommended operating conditions* is not implied. Exposure to absolute-maximum-rated conditions for extended periods may affect device reliability.

(2) These voltages represent the dc voltage + peak ac waveform measured at the terminal of the device in all conditions.

TYPICAL SYSTEM DIAGRAM (Single-ended Mode)

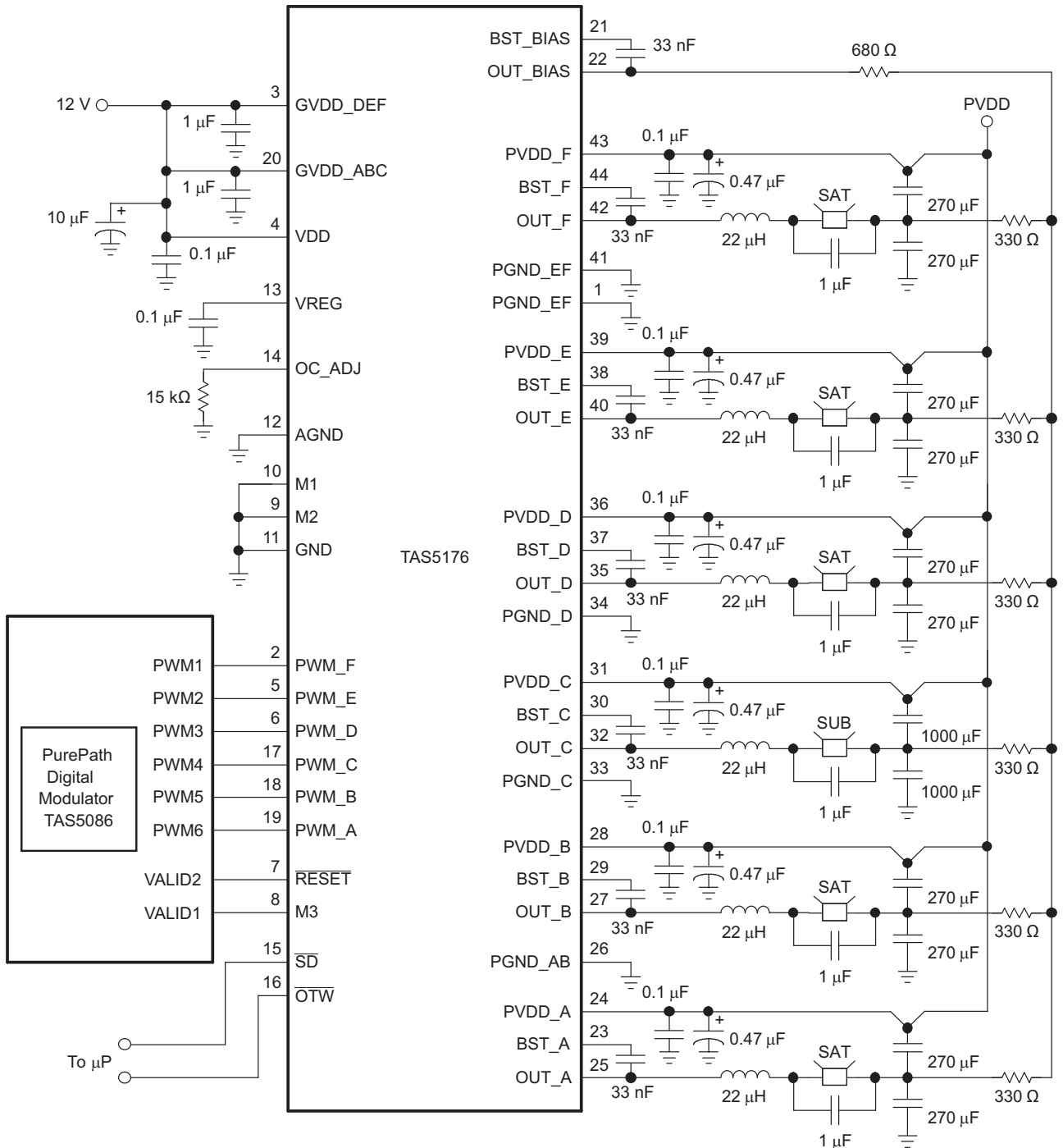

S0061-02

TAS5176

SLES196-JUNE 2007

TYPICAL SYSTEM DIAGRAM (BTL Mode)

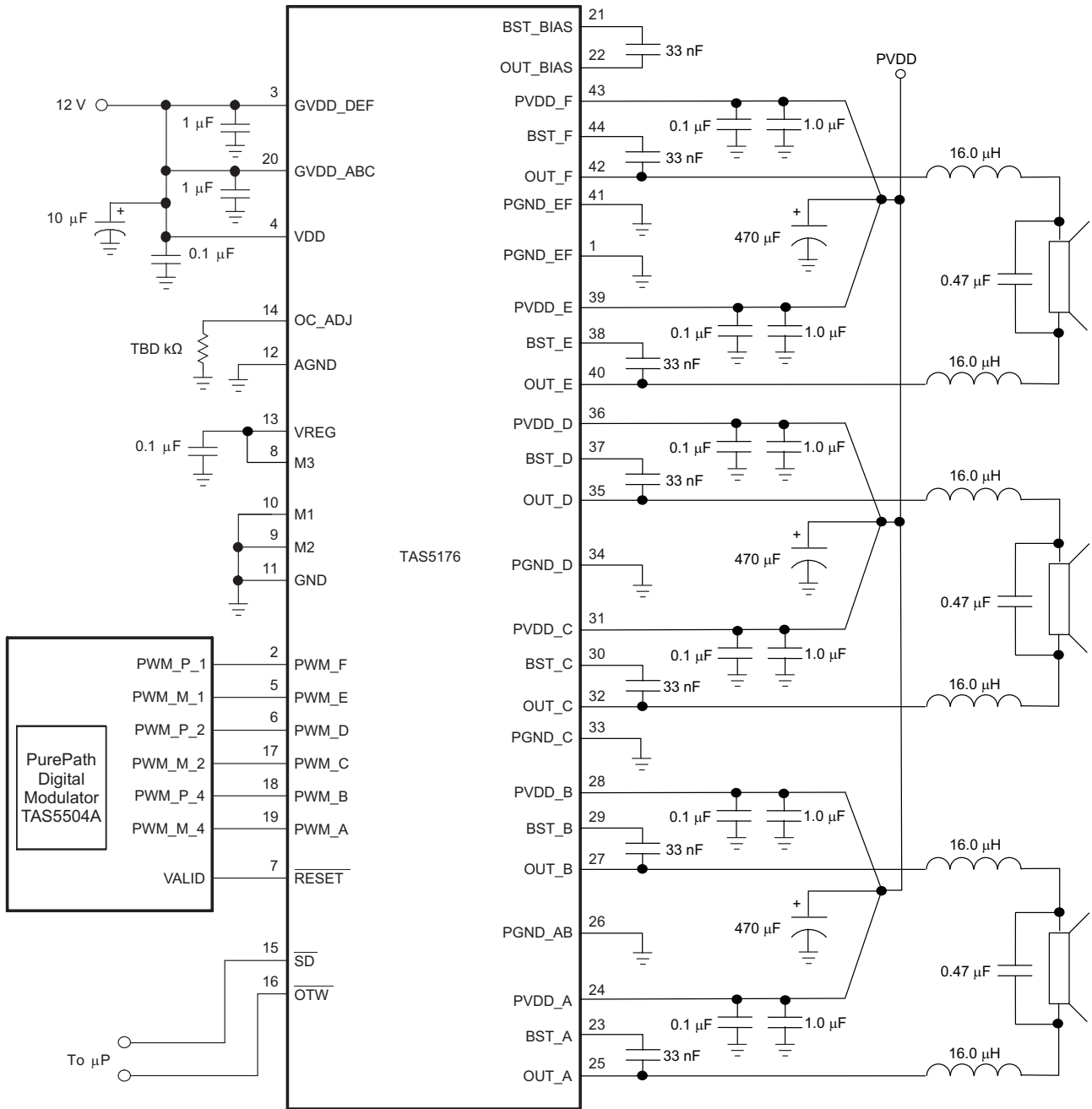

FUNCTIONAL BLOCK DIAGRAM

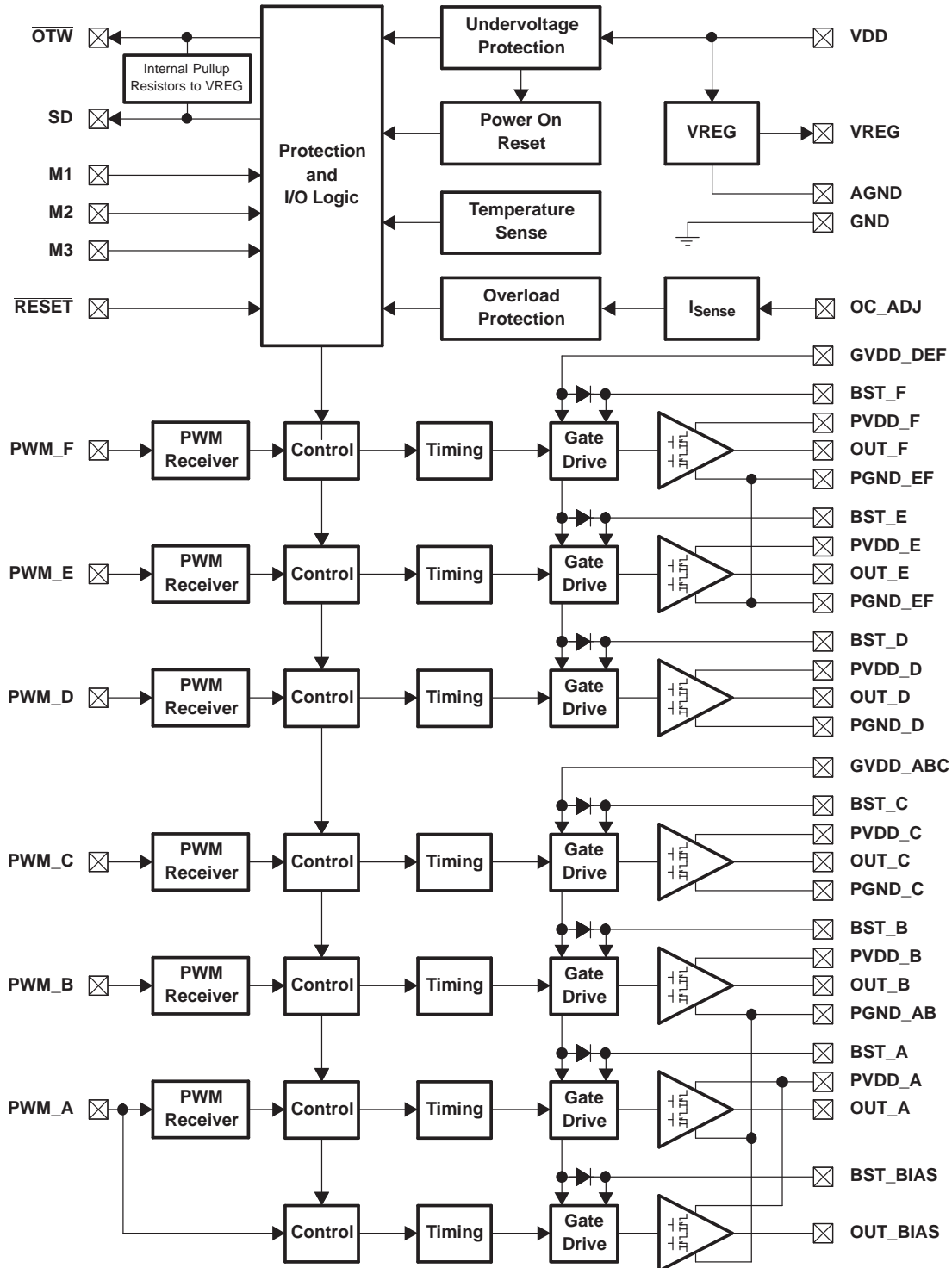

B0034-01

TAS5176

SLES196–JUNE 2007

RECOMMENDED OPERATING CONDITIONS

			MIN	TYP	MAX	UNIT
PVDD_X	Half-bridge supply, SE	DC supply voltage at pin(s)	0	31	34	V
GVDD	Gate drive and guard ring supply voltage	DC voltage at pin(s)	10.8	12	13.2	V
VDD	Digital regulator supply	DC supply voltage at pin	10.8	12	13.2	V
R _{L,SAT}	Resistive load impedance, satellite channels ⁽¹⁾	Recommended demodulation filter	6	8		Ω
R _{L,SUB}	Resistive load impedance, subwoofer channel	Recommended demodulation filter	3.5	4		Ω
L _{output}	Demodulation filter inductance	Minimum output inductance under short-circuit condition	5	22		μH
C _{output,sat}	Demodulation filter capacitance			1		μF
C _{output,sub}	Demodulation filter capacitance			1		μF
F _{PWM}	PWM frame rate		192	384	432	kHz

(1) Load impedance outside range listed might cause shutdown due to OLP, OTE, or NLP.

AUDIO SPECIFICATION (Single-Ended Operation)

 PVDD_X = 31 V, GVDD = 12 V, audio frequency = 1 kHz, AES17 measurement filter, F_{PWM} = 384 kHz, case temperature = 75°C. Audio performance is recorded as a chipset, using TAS5086 PWM processor with an effective modulation index limit of 97%. All performance is in accordance with the foregoing specifications and recommended operating conditions unless otherwise specified.

PARAMETER		CONDITIONS	MIN	TYP	MAX	UNIT
P _{O,sat}	Power output per satellite channel	R _L = 8 Ω, 10% THD, clipped input signal		15		W
		R _L = 8 Ω, 0 dBFS, unclipped input signal		12		
P _{O,sub}	Power output, subwoofer	R _L = 4 Ω, 10% THD, clipped input signal		25		W
		R _L = 4 Ω, 0 dBFS, unclipped input signal		22		
THD + N	Total harmonic distortion + noise, satellite	R _L = 8 Ω, P _O = 10 W		.1		%
		R _L = 8 Ω, 1 W		.05		
	Total harmonic distortion + noise, subwoofer	R _L = 4 Ω, P _O = 20 W		.1		
		R _L = 4 Ω, 1 W		.05		
V _n	Output integrated noise, satellite	A-weighted		55		μV
	Output integrated noise, subwoofer	A-weighted		60		
SNR	System signal-to-noise ratio	A-weighted		105		dB
DNR	Dynamic range ⁽¹⁾	A-weighted, –60 dBFS input signal		105		dB
P _{idle}	Power dissipation due to idle losses (IPVDDX)	P _O = 0 W, all channels running 5.1 mode ⁽²⁾		4.5		W
		P _O = 0 W, 2.1 mode		2.2		W

(1) SNR is calculated relative to 0-dBFS input level.

(2) Actual system idle losses are affected by core losses of output inductors.

AUDIO SPECIFICATION (BTL Operation)

PVDD_X = 24 V, GVDD = 12 V, audio frequency = 1 kHz, AES17 measurement filter, $F_{PWM} = 384$ kHz, case temperature = 75°C. Audio performance is recorded as a chipset, using TAS5086 PWM processor with an effective modulation index limit of 97%. All performance is in accordance with the foregoing specifications and recommended operating conditions unless otherwise specified.

PARAMETER		CONDITIONS	MIN	TYP	MAX	UNIT
P _{O,sat}	Power output per satellite channel	R _L = 8 Ω, 10% THD, clipped input signal		30		W
		R _L = 8 Ω, 0 dBFS, unclipped input signal		20		
P _{O,sub}	Power output subwoofer channel	R _L = 6 Ω, 10% THD, clipped input signal		40		W
		R _L = 6 Ω, 0 dBFS, unclipped input signal		30		
THD + N	Total harmonic distortion + noise	R _L = 8 Ω, P _O = 20 W		.2		%
		R _L = 8 Ω, 1 W		.05		
		R _L = 6 Ω, P _O = 30 W		.2		
		R _L = 6 Ω, 1 W		.05		
V _n	Output integrated noise, satellite	A-weighted		60		μV
	Output integrated noise, subwoofer	A-weighted		65		
SNR	System signal-to-noise ratio	A-weighted		105		dB
DNR	Dynamic range ⁽¹⁾	A-weighted, -60 dBFS input signal		105		dB
P _{idle}	Power dissipation due to idle losses (IPVDDX)	P _O = 0 W, all channels running 5.1 mode ⁽²⁾		4.5		W
		P _O = 0 W, 2.1 mode		2.2		W

(1) SNR is calculated relative to 0-dBFS input level.

(2) Actual system idle losses are affected by core losses of output inductors.

TAS5176

SLES196–JUNE 2007

ELECTRICAL CHARACTERISTICS
 $F_{PWM} = 384 \text{ kHz}$, $PVDD = 31\text{V}$, $GVDD = 12 \text{ V}$, $VDD = 12 \text{ V}$, T_C (case temperature) = 25°C , unless otherwise noted. All performance is in accordance with recommended operating conditions, unless otherwise specified.

SYMBOL	PARAMETER	CONDITIONS	MIN	TYP	MAX	UNIT
INTERNAL VOLTAGE REGULATOR AND CURRENT CONSUMPTION						
VREG	Voltage regulator, only used as reference node	$VDD = 12 \text{ V}$	3	3.3	3.6	V
IVDD	VDD supply current	Operating, 50% duty cycle		7	20	mA
		Idle, reset mode		6	16	
IGVDD_X	Gate supply current per half-bridge	50% duty cycle		5	22	mA
		Idle, reset mode		1	3	
IPVDD_X	Half-bridge idle current	50% duty cycle, without output filter or load, 5.1 mode		180		mA
		50% duty cycle, without output filter or load, 2.1 mode		100		
OUTPUT STAGE MOSFETS						
$R_{DS(on)}$, LS Sat	Drain-to-source resistance, low side, satellite	$T_J = 25^\circ\text{C}$, includes metallization resistance		210		$\text{m}\Omega$
$R_{DS(on)}$, HS Sat	Drain-to-source resistance, high side, satellite	$T_J = 25^\circ\text{C}$, includes metallization resistance		210		$\text{m}\Omega$
$R_{DS(on)}$, LS Sub	Drain-to-source resistance, low side, subwoofer	$T_J = 25^\circ\text{C}$, includes metallization resistance		110		$\text{m}\Omega$
$R_{DS(on)}$, HS Sub	Drain-to-source resistance, high side, subwoofer	$T_J = 25^\circ\text{C}$, includes metallization resistance		110		$\text{m}\Omega$
I/O PROTECTION						
$V_{UVP, G}$	Undervoltage protection limit $GVDD_X$			10		V
$V_{UVP, hyst}^{(1)}$	Undervoltage protection hysteresis			250		mV
OTW ⁽¹⁾	Overtemperature warning			125		$^\circ\text{C}$
OTW _{hyst} ⁽¹⁾	Temperature drop needed below OTW temp. for OTW to be inactive after the OTW event			25		$^\circ\text{C}$
OTE ⁽¹⁾	Overtemperature error			155		$^\circ\text{C}$
OTE _{hyst} ⁽¹⁾	Temperature drop needed below OTE temp. for \overline{SD} to be released after the OTE event			25		$^\circ\text{C}$
OLCP	Overload protection counter		1.25			ms
I_{OC}	Overcurrent limit protection, sat.	Resistor programmable, high end, $R_{ocp} = 18 \text{ k}\Omega$		4.5		A
	Overcurrent limit protection, sub.	Resistor programmable, high end, $R_{ocp} = 18 \text{ k}\Omega$		8		A
I_{OCT}	Overcurrent response time			210		ns
R_{ocp}	OC programming resistor range	Resistor tolerance = 5%		27		$\text{k}\Omega$
STATIC DIGITAL SPECIFICATION						
V_{IH}	High-level input voltage	PWM_X, M1, M2, M3, RESET		2		V
V_{IL}	Low-level input voltage				0.8	
I_{lkq}	Input leakage current	Static condition	-80		80	μA
OTW/SHUTDOWN (SD)						
R_{INT_PU}	Internal pullup resistor to DREG (3.3 V) for \overline{SD} and OTW			26		$\text{k}\Omega$
V_{OH}	High-level output voltage	Internal pullup resistor only	3	3.3	3.6	V
		External pullup: 4.7-k Ω resistor to 5 V	4.5		5	
V_{OL}	Low-level output voltage	$I_O = 4 \text{ mA}$		0.2	0.4	
FANOUT	Device fanout OTW, \overline{SD}	No external pullup		30		Devices

(1) Specified by design.

TYPICAL CHARACTERISTICS, 5.1 MODE

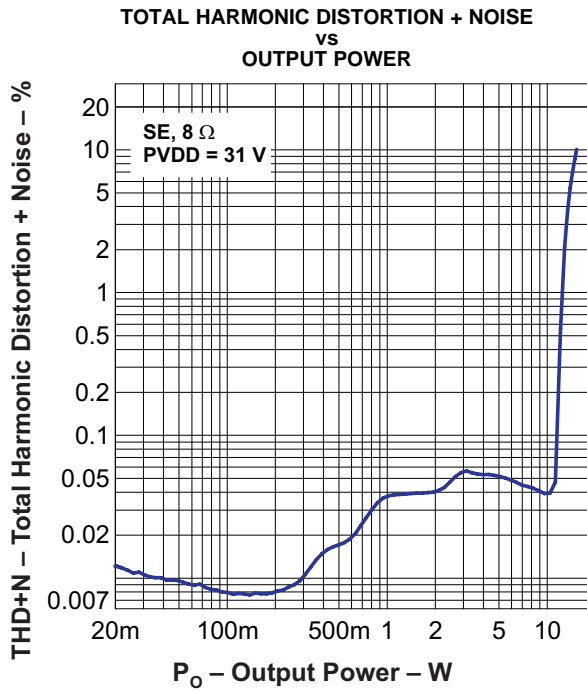

Figure 1.

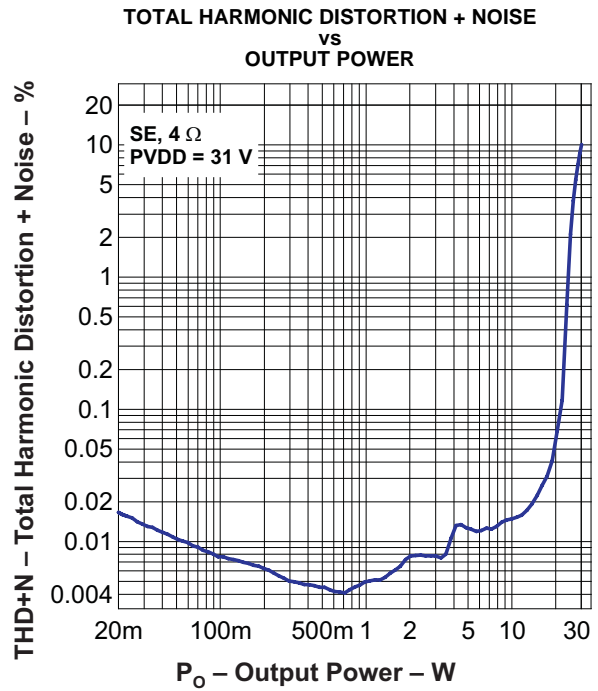

Figure 2.

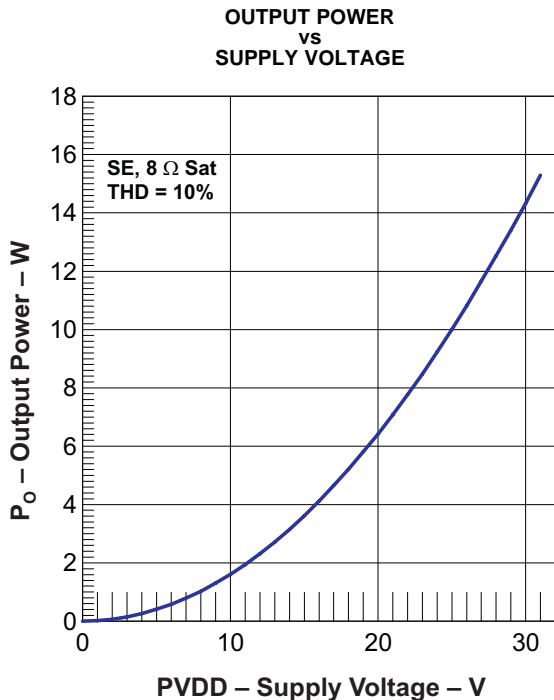

Figure 3.

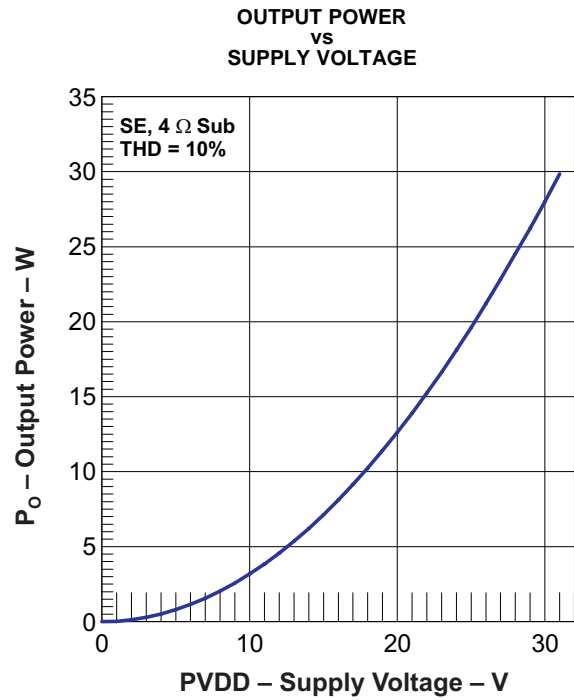

Figure 4.

TAS5176



SLES196–JUNE 2007

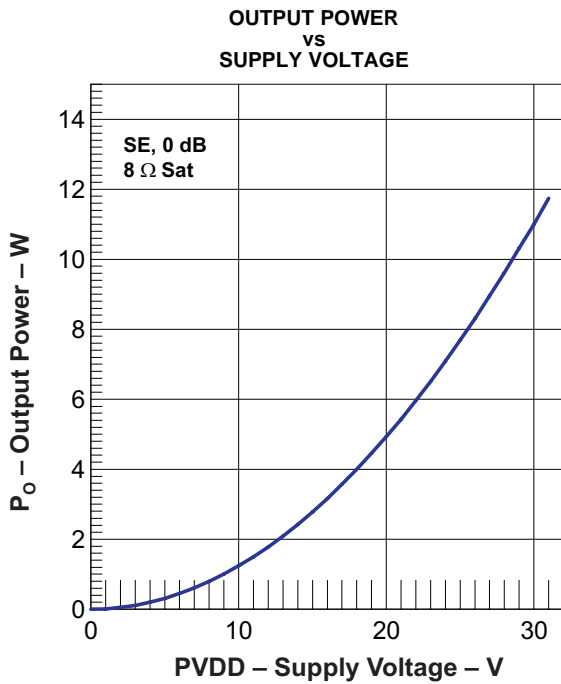

Figure 5.

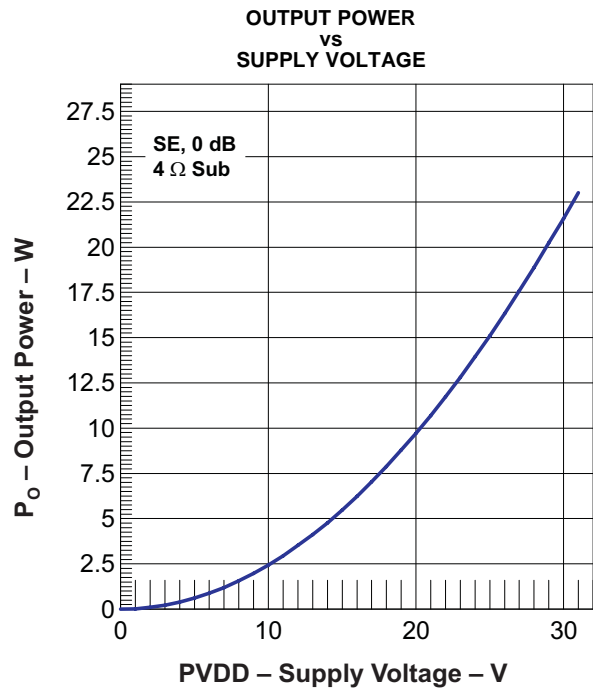

Figure 6.

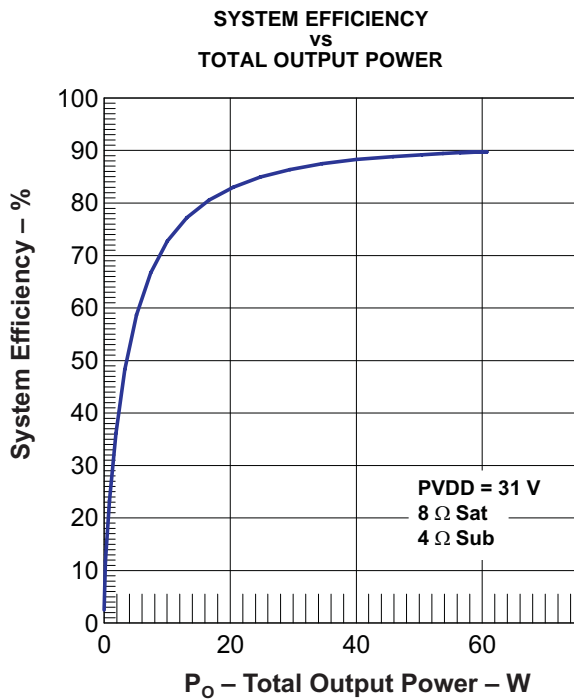

Figure 7.

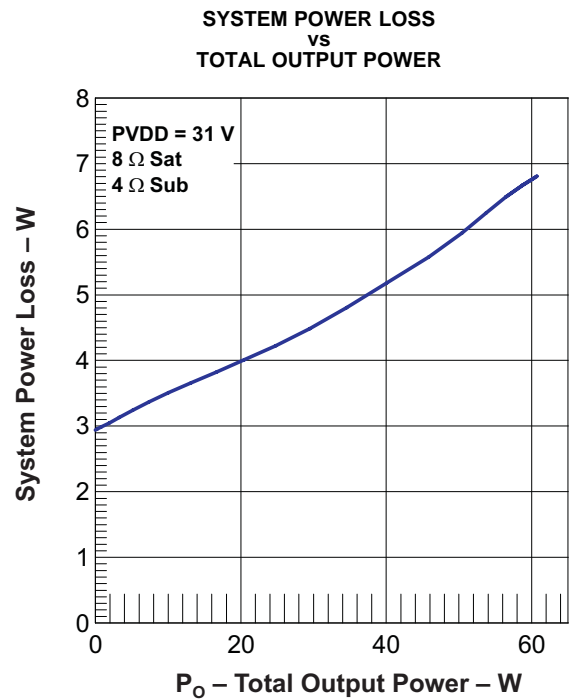

Figure 8.

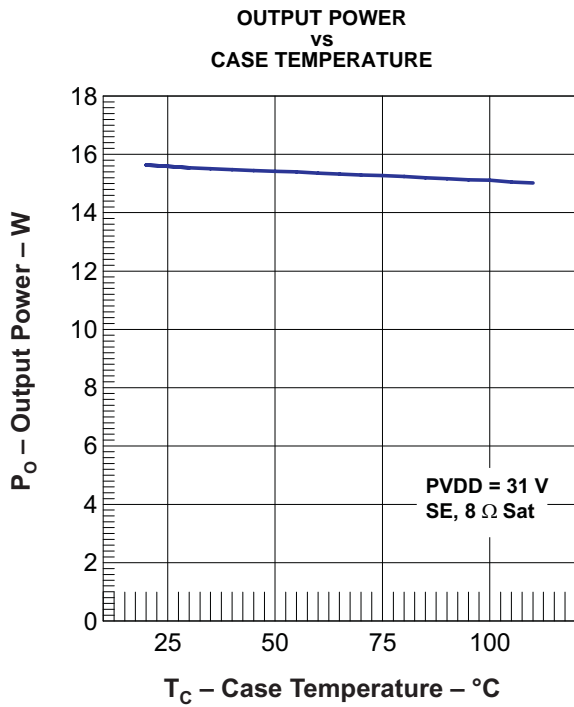

Figure 9.

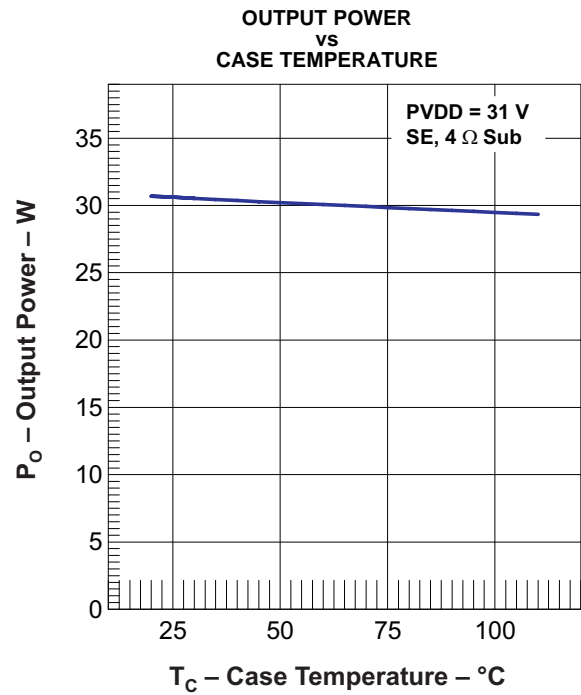

Figure 10.

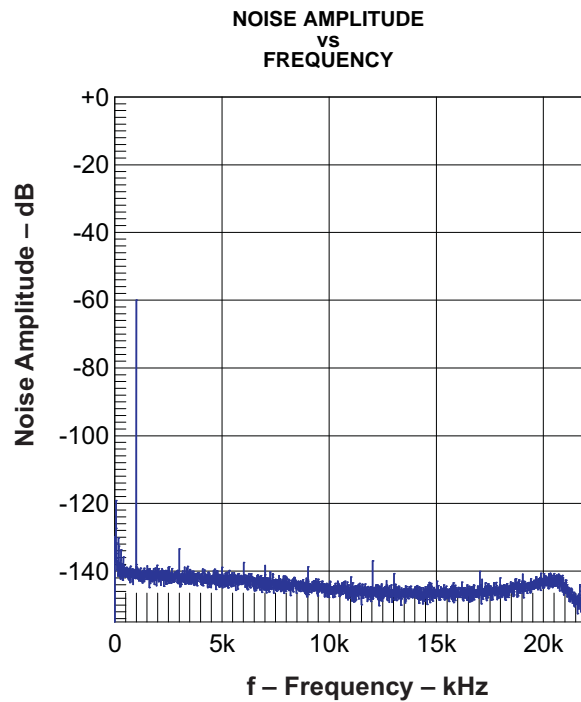

Figure 11.

TYPICAL CHARACTERISTICS, 3.0 BTL MODE

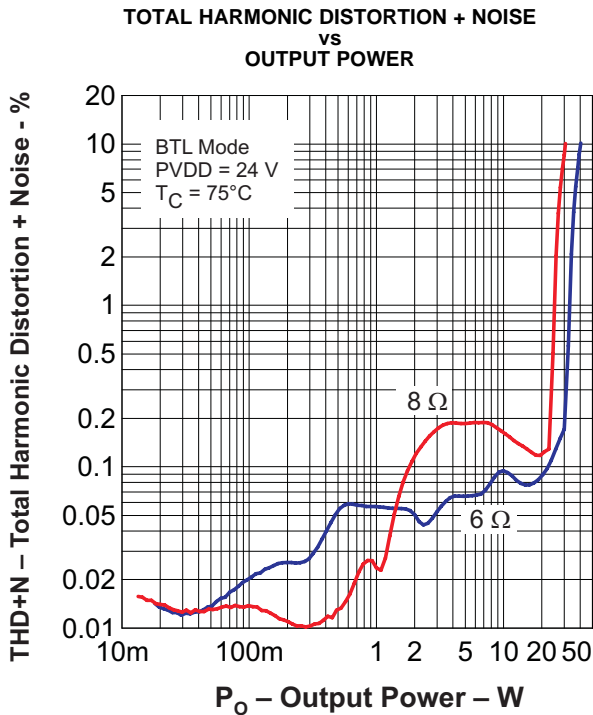

Figure 12.

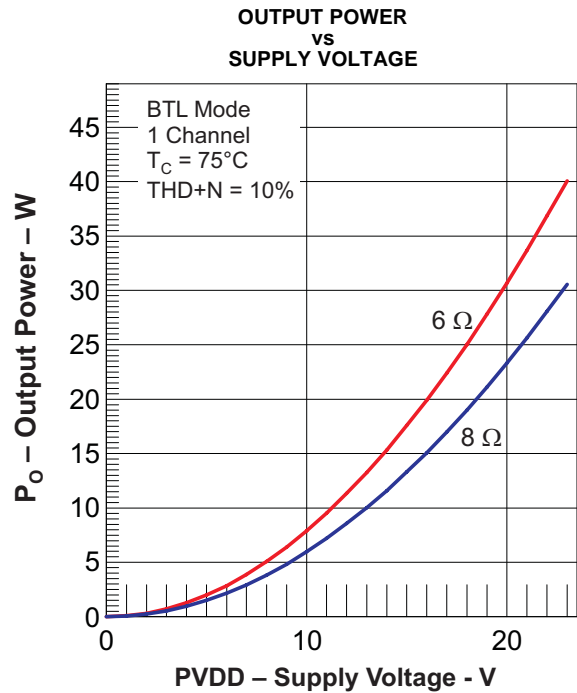

Figure 13.

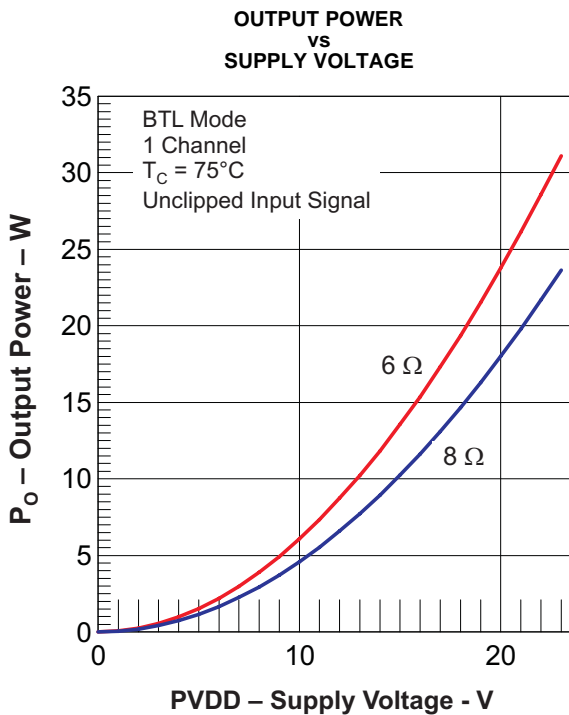

Figure 14.

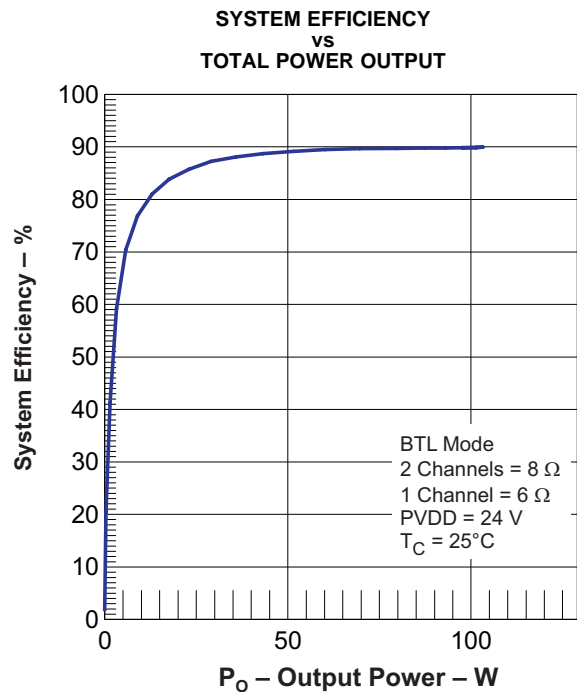
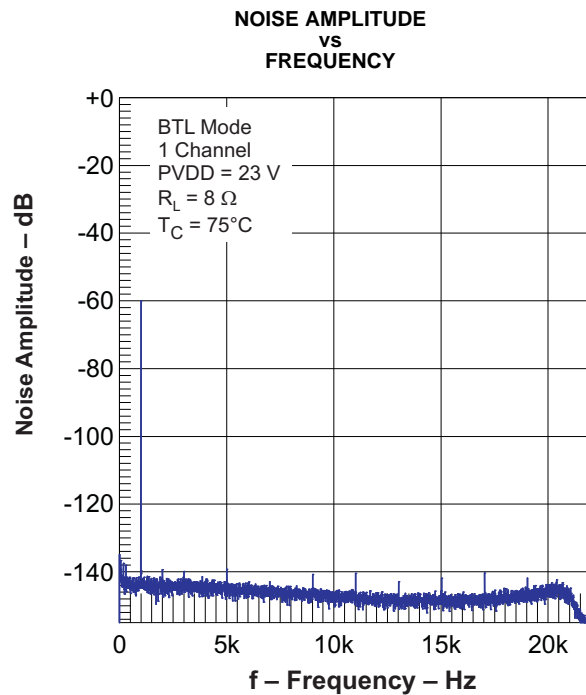
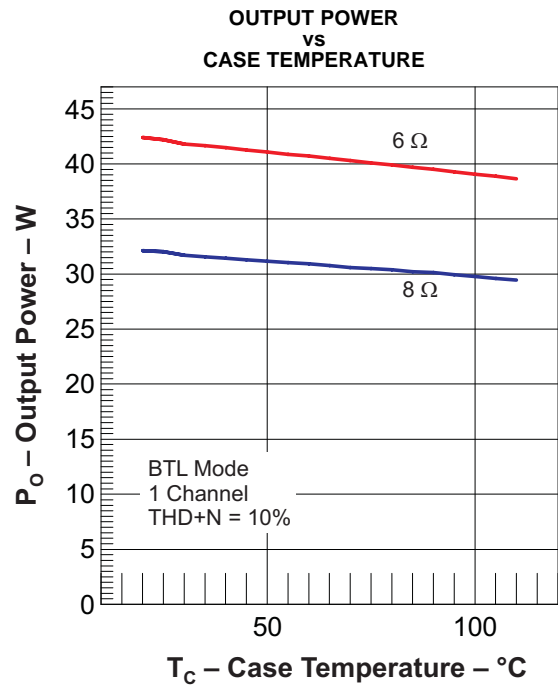
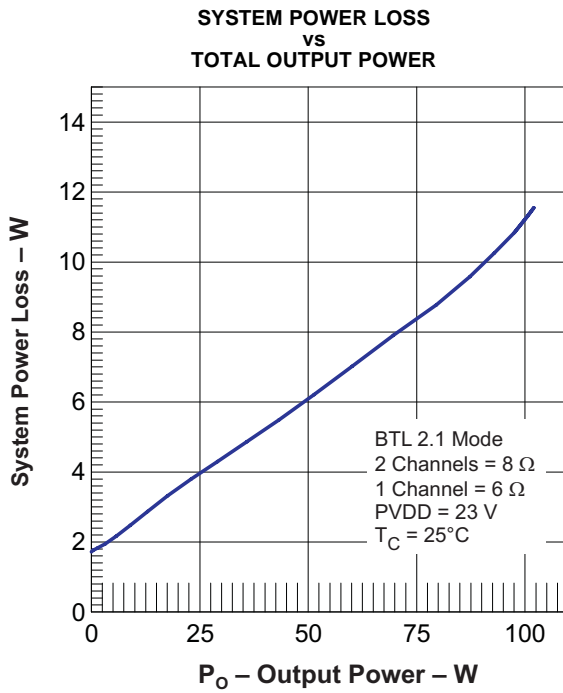

Figure 15.



TAS5176

SLES196–JUNE 2007

THEORY OF OPERATION

POWER SUPPLIES

To facilitate system design, the TAS5176 needs only a 12-V supply in addition to a typical 31-V power-stage supply. An internal voltage regulator provides suitable voltage levels for the digital and low-voltage analog circuitry. Additionally, all circuitry requiring a floating voltage supply, e.g., the high-side gate drive, is accommodated by built-in bootstrap circuitry requiring only a few external capacitors.

In order to provide outstanding electrical and acoustic characteristics, the PWM signal path including gate drive and output stage is designed as identical, independent half-bridges. For this reason, each half-bridge has separate bootstrap pins (BST_X) and power-stage supply pins (PVDD_X). Furthermore, an additional pin (VDD) is provided as power supply for all common circuits. Although supplied from the same 12-V source, it is highly recommended to separate GVDD_X and VDD on the printed-circuit board (PCB) by RC filters (see application diagram for details). These RC filters provide the recommended high-frequency isolation. Special attention should be paid to placing all decoupling capacitors as close to their associated pins as possible. In general, inductance between the power-supply pins and decoupling capacitors must be avoided. (See reference board documentation for additional information.)

For a properly functioning bootstrap circuit, a small ceramic capacitor must be connected from each bootstrap pin (BST_X) to the power-stage output pin (OUT_X). When the power-stage output is low, the bootstrap capacitor is charged through an internal diode connected between the gate-drive power-supply pin (GVDD_X) and the bootstrap pin. When the power-stage output voltage is high, the bootstrap capacitor voltage is shifted above the output voltage potential and thus provides a suitable voltage supply for the high-side gate driver. In an application with PWM switching frequencies in the range 352 kHz to 384 kHz, it is recommended to use 33-nF ceramic capacitors, size 0603 or 0805, for the bootstrap capacitor. These 33-nF capacitors ensure sufficient energy storage, even during minimal PWM duty cycles, to keep the high-side power stage FET (LDMOS) fully started during all of the remaining part of the PWM cycle. In an application running at a reduced switching frequency, generally 250 kHz to 192 kHz, the bootstrap capacitor might need to be increased in value. Special attention should be paid to the power-stage power supply; this includes component selection, PCB placement and routing. As indicated, each half-bridge has independent power-stage supply pins (PVDD_X). For optimal electrical performance, EMI compliance, and system

reliability it is important that each PVDD_X pin is decoupled with a 100-nF ceramic capacitor placed as close as possible to each supply pin on the same side of the PCB as the TAS5176. It is recommended to follow the PCB layout and PowerPad layout of the TAS5176 reference design. For additional information on the recommended power supply and required components, see the application diagrams given in this data sheet. The 12-V supply should be powered from a low-noise, low-output-impedance voltage regulator. Likewise, the PVDD power-stage supply is assumed to have low output impedance and low noise. The power-supply sequence is not critical due to the internal power-on-reset circuit. Moreover, the TAS5176 is fully protected against erroneous power-stage turnon due to parasitic gate charging. Thus, voltage-supply ramp rates (dv/dt) are typically noncritical.

SYSTEM POWER-UP/DOWN SEQUENCE

The TAS5176 does not require a power-up sequence. The outputs of the H-bridge remain in a high-impedance state until the gate-drive supply voltage (GVDD_X) and VDD voltage are above the undervoltage protection (UVP) voltage threshold (see the *Electrical Characteristics* section of this data sheet). Although not specifically required, it is recommended to hold RESET in a low state while powering up the device.

When the TAS5176 is being used with TI PWM modulators such as the TAS5086, no special attention to the state of RESET is required, provided that the chipset is configured as recommended.

Powering Down

The TAS5176 does not require a power-down sequence. The device remains fully operational as long as the gate-drive supply (GVDD_X) voltage and VDD voltage are above the undervoltage protection (UVP) threshold level (see the *Electrical Characteristics* section of this data sheet). Although not specifically required, it is a good practice to hold RESET low during power down, thus preventing audible artifacts including pops and clicks.

When the TAS5176 is being used with TI PWM modulators such as the TAS5086, no special attention to the state of RESET is required, provided that the chipset is configured as recommended.

Error Reporting

The \overline{SD} and \overline{OTW} pins are both active-low, open-drain outputs. Their function is for protection-mode signaling to a PWM controller or other system-control device.

Any fault resulting in device shutdown is signaled by the \overline{SD} pin going low. Likewise, \overline{OTW} goes low when the device junction temperature exceeds 125°C (see the following table).

\overline{SD}	\overline{OTW}	DESCRIPTION
0	0	Overtemperature (OTE) or overload (OLP) or undervoltage (UVP)
0	1	Overload (OLP) or undervoltage (UVP)
1	0	Overtemperature warning. Junction temperature higher than 125°C, typical
1	1	Normal operation. Junction temperature lower than 125°C, typical

It should be noted that asserting \overline{RESET} low forces the \overline{SD} and \overline{OTW} signals high independently of faults being present. It is recommended to monitor the \overline{OTW} signal using the system microcontroller and to respond to an overtemperature warning signal by, e.g., turning down the volume to prevent further heating of the device that would result in device shutdown (OTE). To reduce external component count, an internal pullup resistor to 3.3 V is provided on both the \overline{SD} and \overline{OTW} outputs. Level compliance for 5-V logic can be obtained by adding external pullup resistors to 5 V (see the *Electrical Characteristics* section of this data sheet for further specifications).

Device Protection System

The TAS5176 contains advanced protection circuitry carefully designed to facilitate system integration and ease of use, as well as safeguarding the device from permanent failure due to a wide range of fault conditions such as short circuit, overload, and undervoltage. The TAS5176 responds to a fault by immediately setting the power stage in a high-impedance state (Hi-Z) and asserting the \overline{SD} pin low. In situations other than overload, the device automatically recovers when the fault condition has been removed, e.g., the supply voltage has increased or the temperature has dropped. For highest possible reliability, recovering from an overload fault requires external reset of the device no sooner than 1 second after the shutdown (see the *Device Reset* section of this data sheet).

OVERCURRENT (OC) PROTECTION WITH CURRENT LIMITING AND OVERLOAD DETECTION

The device has independent, fast-reacting current detectors with programmable trip threshold (OC threshold) on all high-side and low-side power-stage FETs. See the following table for OC-adjust resistor values. The detector outputs are closely monitored by two protection systems. The first protection

system controls the power stage in order to prevent the output current from further increasing. I.e., it performs a current-limiting function rather than prematurely shutting down during combinations of high-level music transients and extreme speaker load-impedance drops. If the high-current situation persists, i.e., the power stage is being overloaded, a second protection system triggers a latching shutdown, resulting in the power stage being set in the high-impedance (Hi-Z) state.

For added flexibility, the OC threshold is programmable within a limited range using a single external resistor connected between the OC_ADJ pin and AGND.

OC-Adjust Resistor Values (kΩ)	Maximum Current Before OC Occurs (A)
18K	4.5 (sat), 8.0 (sub)
27K	TBD

It should be noted that a properly functioning overcurrent detector assumes the presence of a properly designed demodulation filter at the power-stage output. Short-circuit protection is not provided directly at the output pins of the power stage but only on the speaker terminals (after the demodulation filter). It is required to follow certain guidelines when selecting the OC threshold and an appropriate demodulation inductor.

- For the lowest-cost bill of materials in terms of component selection, the OC threshold current should be limited, considering the power output requirement and minimum load impedance. Higher-impedance loads require a lower OC threshold.
- The demodulation filter inductor must retain at least 5 μH of inductance at twice the OC threshold setting.

Most inductors have decreasing inductance with increasing temperature and increasing current (saturation). To some degree, an increase in temperature naturally occurs when operating at high output currents, due to inductor core losses and the dc resistance of the inductor copper winding. A thorough analysis of inductor saturation and thermal properties is strongly recommended.

Setting the OC threshold too low might cause issues such as lack of output power and/or unexpected shutdowns due to sensitive overload detection.

In general, it is recommended to follow closely the external component selection and PCB layout as given in the application section.

TAS5176

SLES196–JUNE 2007

OVERTEMPERATURE PROTECTION

The TAS5176 has a two-level temperature-protection system that asserts an active-low warning signal (\overline{OTW}) when the device junction temperature exceeds 125°C (typical), and if the device junction temperature exceeds 155°C (typical), the device is put into thermal shutdown, resulting in all half-bridge outputs being set in the high-impedance state (Hi-Z) and \overline{SD} being asserted low.

THERMAL CONSIDERATIONS

The TAS5176 device package (DDW) is designed with the PowerPad on the bottom of the device. It must be soldered to the ground plane on the printed circuit board (PCB). Under the PowerPad, there should be a pattern of vias to conduct heat through the PCB to the bottom layer ground plane. Using this technique alone, the device is capable of a total continuous power of 80 Watts.

Additional heatsinking is required for total continuous power of 100 Watts. An exposed area in the bottom layer soldermask can be created and then an aluminum bracket mechanically and thermally coupled (with heatsink paste) to the exposed area. The other end of the aluminum bracket can then be mechanically and thermally connected to the system chassis. This technique will allow the TAS5176 to run at higher ambient temperatures and/or deliver more power.

UNDERVOLTAGE PROTECTION (UVP) AND POWER-ON RESET (POR)

The UVP and POR circuits of the TAS5176 fully protect the device in any power-up/down and brownout situation. While powering up, the POR circuit resets the overload circuit (OLP) and ensures that all circuits are fully operational when the GVDD_X and VDD supply voltages reach 10 V (typical). Although GVDD_X and VDD are independently monitored, a supply voltage drop below the UVP threshold on any VDD or GVDD_X pin results in all half-bridge outputs immediately being set in the high-impedance (Hi-Z) state and \overline{SD} being asserted low. The device automatically resumes operation when all supply voltages have increased above the UVP threshold.

DEVICE RESET

When \overline{RESET} is asserted low, the output FETs in all half-bridges are forced into a high-impedance (Hi-Z) state.

Asserting the \overline{RESET} input low removes any fault information to be signaled on the \overline{SD} output, i.e., \overline{SD} is forced high.

A rising-edge transition on the \overline{RESET} input allows the device to resume operation after an overload fault.

ACTIVE-BIAS CONTROL (ABC)

Audible pop noises are often associated with single-rail, single-ended power stages at power-up or at the start of switching. This commonly known problem has been virtually eliminated by incorporating a proprietary active-bias control circuitry as part of the TAS5176 feature set. By the use of only a few passive external components (typically resistors), the ABC can pre-charge the dc-blocking element in the audio path, i.e., split-cap capacitors or series capacitor, to the desired potential before switching is started on the PWM outputs. (For recommended configuration, see the typical application schematic included in this data sheet).

The start-up sequence can be controlled through sequencing the M3 and \overline{RESET} pins according to Table 2 and Table 3.

Table 2. 5.1 Mode—All Output Channels Active

M3	\overline{RESET}	OUT_BIAS	OUT_A, _B, _C	OUT_D, _E, _F	COMMENT
0	0	Hi-Z	Hi-Z	Hi-Z	All outputs disabled, nothing is switching.
1	0	Active	Hi-Z	Hi-Z	OUT_BIAS enabled, all other outputs disabled
1	1	Hi-Z	Active	Active	OUT_BIAS disabled, all other outputs switching

Table 3. 2.1 Mode—Only Output Channels A, B, and C Active

M3	\overline{RESET}	OUT_BIAS	OUT_A, _B, _C	OUT_D, _E, _F	COMMENT
0	0	Hi-Z	Hi-Z	Hi-Z	All outputs disabled, nothing is switching.
1	0	Active	Hi-Z	Hi-Z	OUT_BIAS enabled, all other outputs disabled
0	1	Hi-Z	Active	Hi-Z	OUT_BIAS disabled, all other outputs switching

Table 4. 3.0 Mode—Output Channels In BTL Mode

M3	RESET	OUT_BIAS	OUT_A, _B, _C	OUT_D, _E, _F	COMMENT
0	0	Hi-Z	Hi-Z	Hi-Z	All outputs disabled, nothing is switching.

M3	RESET	OUT_BIAS	OUT_A, _B, _C	OUT_D, _E, _F	COMMENT
1	0	Active	Hi-Z	Hi-Z	OUT_BIAS enabled, all other outputs disabled
0	1	Hi-Z	Active	Hi-Z	OUT_BIAS disabled, all other outputs switching

When the TAS5176 is used with the TAS5086 PWM modulator, no special attention to start-up sequencing is required, provided that the chipset is configured as recommended.



PACKAGING INFORMATION

Orderable Device	Status (1)	Package Type	Package Drawing	Pins	Package Qty	Eco Plan (2)	Lead/Ball Finish (6)	MSL Peak Temp (3)	Op Temp (°C)	Device Marking (4/5)	Samples
TAS5176DDW	ACTIVE	HTSSOP	DDW	44	35	Green (RoHS & no Sb/Br)	CU NIPDAU	Level-3-260C-168 HR		TAS5176	

(1) The marketing status values are defined as follows:

ACTIVE: Product device recommended for new designs.

LIFEBUY: TI has announced that the device will be discontinued, and a lifetime-buy period is in effect.

NRND: Not recommended for new designs. Device is in production to support existing customers, but TI does not recommend using this part in a new design.

PREVIEW: Device has been announced but is not in production. Samples may or may not be available.

OBSELETE: TI has discontinued the production of the device.

(2) Eco Plan - The planned eco-friendly classification: Pb-Free (RoHS), Pb-Free (RoHS Exempt), or Green (RoHS & no Sb/Br) - please check <http://www.ti.com/productcontent> for the latest availability information and additional product content details.

TBD: The Pb-Free/Green conversion plan has not been defined.

Pb-Free (RoHS): TI's terms "Lead-Free" or "Pb-Free" mean semiconductor products that are compatible with the current RoHS requirements for all 6 substances, including the requirement that lead not exceed 0.1% by weight in homogeneous materials. Where designed to be soldered at high temperatures, TI Pb-Free products are suitable for use in specified lead-free processes.

Pb-Free (RoHS Exempt): This component has a RoHS exemption for either 1) lead-based flip-chip solder bumps used between the die and package, or 2) lead-based die adhesive used between the die and leadframe. The component is otherwise considered Pb-Free (RoHS compatible) as defined above.

Green (RoHS & no Sb/Br): TI defines "Green" to mean Pb-Free (RoHS compatible), and free of Bromine (Br) and Antimony (Sb) based flame retardants (Br or Sb do not exceed 0.1% by weight in homogeneous material)

(3) MSL, Peak Temp. - The Moisture Sensitivity Level rating according to the JEDEC industry standard classifications, and peak solder temperature.

(4) There may be additional marking, which relates to the logo, the lot trace code information, or the environmental category on the device.

(5) Multiple Device Markings will be inside parentheses. Only one Device Marking contained in parentheses and separated by a "-" will appear on a device. If a line is indented then it is a continuation of the previous line and the two combined represent the entire Device Marking for that device.

(6) Lead/Ball Finish - Orderable Devices may have multiple material finish options. Finish options are separated by a vertical ruled line. Lead/Ball Finish values may wrap to two lines if the finish value exceeds the maximum column width.

Important Information and Disclaimer: The information provided on this page represents TI's knowledge and belief as of the date that it is provided. TI bases its knowledge and belief on information provided by third parties, and makes no representation or warranty as to the accuracy of such information. Efforts are underway to better integrate information from third parties. TI has taken and continues to take reasonable steps to provide representative and accurate information but may not have conducted destructive testing or chemical analysis on incoming materials and chemicals. TI and TI suppliers consider certain information to be proprietary, and thus CAS numbers and other limited information may not be available for release.

In no event shall TI's liability arising out of such information exceed the total purchase price of the TI part(s) at issue in this document sold by TI to Customer on an annual basis.



Distributor of Texas Instruments: Excellent Integrated System Limited

Datasheet of TAS5176DDW - IC AMP AUDIO PWR 40W D 44TSSOP

Contact us: sales@integrated-circuit.com Website: www.integrated-circuit.com

PACKAGE OPTION ADDENDUM



www.ti.com

24-Aug-2014

THERMAL PAD MECHANICAL DATA

DDW (R-PDSO-G44)

PowerPAD™ SMALL OUTLINE PACKAGE

THERMAL INFORMATION

This PowerPAD™ package incorporates an exposed thermal pad that is designed to be attached to a printed circuit board (PCB). The thermal pad must be soldered directly to the PCB. After soldering, the PCB can be used as a heatsink. In addition, through the use of thermal vias, the thermal pad can be attached directly to the appropriate copper plane shown in the electrical schematic for the device, or alternatively, can be attached to a special heatsink structure designed into the PCB. This design optimizes the heat transfer from the integrated circuit (IC).

For additional information on the PowerPAD package and how to take advantage of its heat dissipating abilities, refer to Technical Brief, PowerPAD Thermally Enhanced Package, Texas Instruments Literature No. SLMA002 and Application Brief, PowerPAD Made Easy, Texas Instruments Literature No. SLMA004. Both documents are available at www.ti.com.

The exposed thermal pad dimensions for this package are shown in the following illustration.

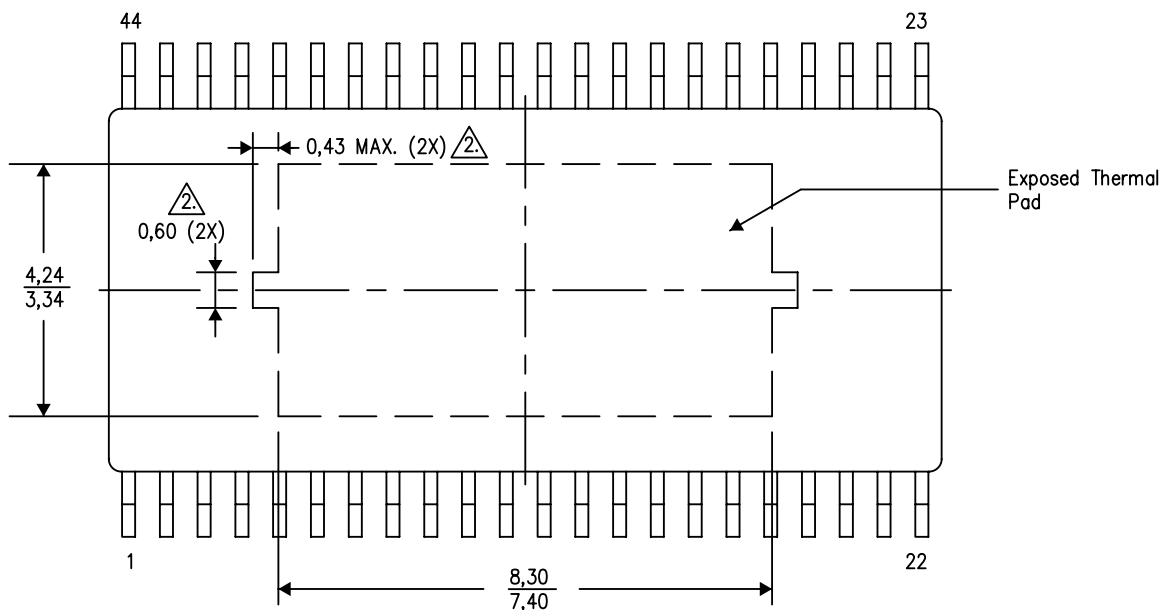

Top View

- 1. All linear dimensions are in millimeters
- △. These features may not be present.

Exposed Thermal Pad Dimensions

IMPORTANT NOTICE

Texas Instruments Incorporated and its subsidiaries (TI) reserve the right to make corrections, enhancements, improvements and other changes to its semiconductor products and services per JESD46, latest issue, and to discontinue any product or service per JESD48, latest issue. Buyers should obtain the latest relevant information before placing orders and should verify that such information is current and complete. All semiconductor products (also referred to herein as "components") are sold subject to TI's terms and conditions of sale supplied at the time of order acknowledgment.

TI warrants performance of its components to the specifications applicable at the time of sale, in accordance with the warranty in TI's terms and conditions of sale of semiconductor products. Testing and other quality control techniques are used to the extent TI deems necessary to support this warranty. Except where mandated by applicable law, testing of all parameters of each component is not necessarily performed.

TI assumes no liability for applications assistance or the design of Buyers' products. Buyers are responsible for their products and applications using TI components. To minimize the risks associated with Buyers' products and applications, Buyers should provide adequate design and operating safeguards.

TI does not warrant or represent that any license, either express or implied, is granted under any patent right, copyright, mask work right, or other intellectual property right relating to any combination, machine, or process in which TI components or services are used. Information published by TI regarding third-party products or services does not constitute a license to use such products or services or a warranty or endorsement thereof. Use of such information may require a license from a third party under the patents or other intellectual property of the third party, or a license from TI under the patents or other intellectual property of TI.

Reproduction of significant portions of TI information in TI data books or data sheets is permissible only if reproduction is without alteration and is accompanied by all associated warranties, conditions, limitations, and notices. TI is not responsible or liable for such altered documentation. Information of third parties may be subject to additional restrictions.

Resale of TI components or services with statements different from or beyond the parameters stated by TI for that component or service voids all express and any implied warranties for the associated TI component or service and is an unfair and deceptive business practice. TI is not responsible or liable for any such statements.

Buyer acknowledges and agrees that it is solely responsible for compliance with all legal, regulatory and safety-related requirements concerning its products, and any use of TI components in its applications, notwithstanding any applications-related information or support that may be provided by TI. Buyer represents and agrees that it has all the necessary expertise to create and implement safeguards which anticipate dangerous consequences of failures, monitor failures and their consequences, lessen the likelihood of failures that might cause harm and take appropriate remedial actions. Buyer will fully indemnify TI and its representatives against any damages arising out of the use of any TI components in safety-critical applications.

In some cases, TI components may be promoted specifically to facilitate safety-related applications. With such components, TI's goal is to help enable customers to design and create their own end-product solutions that meet applicable functional safety standards and requirements. Nonetheless, such components are subject to these terms.

No TI components are authorized for use in FDA Class III (or similar life-critical medical equipment) unless authorized officers of the parties have executed a special agreement specifically governing such use.

Only those TI components which TI has specifically designated as military grade or "enhanced plastic" are designed and intended for use in military/aerospace applications or environments. Buyer acknowledges and agrees that any military or aerospace use of TI components which have **not** been so designated is solely at the Buyer's risk, and that Buyer is solely responsible for compliance with all legal and regulatory requirements in connection with such use.

TI has specifically designated certain components as meeting ISO/TS16949 requirements, mainly for automotive use. In any case of use of non-designated products, TI will not be responsible for any failure to meet ISO/TS16949.

Products

Audio	www.ti.com/audio
Amplifiers	amplifier.ti.com
Data Converters	dataconverter.ti.com
DLP® Products	www.dlp.com
DSP	dsp.ti.com
Clocks and Timers	www.ti.com/clocks
Interface	interface.ti.com
Logic	logic.ti.com
Power Mgmt	power.ti.com
Microcontrollers	microcontroller.ti.com
RFID	www.ti-rfid.com
OMAP Applications Processors	www.ti.com/omap
Wireless Connectivity	www.ti.com/wirelessconnectivity

Applications

Automotive and Transportation	www.ti.com/automotive
Communications and Telecom	www.ti.com/communications
Computers and Peripherals	www.ti.com/computers
Consumer Electronics	www.ti.com/consumer-apps
Energy and Lighting	www.ti.com/energy
Industrial	www.ti.com/industrial
Medical	www.ti.com/medical
Security	www.ti.com/security
Space, Avionics and Defense	www.ti.com/space-avionics-defense
Video and Imaging	www.ti.com/video

TI E2E Community

e2e.ti.com