

## Excellent Integrated System Limited

Stocking Distributor

Click to view price, real time Inventory, Delivery & Lifecycle Information:

[IXYS Corporation](#)

[VBO78-08NO7](#)

For any questions, you can email us directly:

[sales@integrated-circuit.com](mailto:sales@integrated-circuit.com)

## Standard Rectifier Module

<b>1~ Rectifier</b>	
$V_{RRM}$	= 800 V
$I_{DAV}$	= 80 A
$I_{FSM}$	= 750 A

### 1~ Rectifier Bridge

Part number

**VBO78-08NO7**

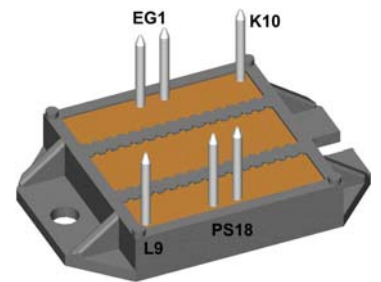

 E72873

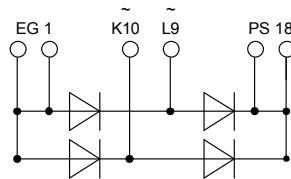

#### Features / Advantages:

- Package with DCB ceramic
- Improved temperature and power cycling
- Planar passivated chips
- Very low forward voltage drop
- Very low leakage current

#### Applications:

- Diode for main rectification
- For one phase bridge configurations
- Supplies for DC power equipment
- Input rectifiers for PWM inverter
- Battery DC power supplies
- Field supply for DC motors

#### Package: ECO-PAC2

- Industry standard outline
- RoHS compliant
- Soldering pins for PCB mounting
- Height: 9 mm
- Base plate: DCB ceramic
- Reduced weight
- Advanced power cycling

Rectifier				Ratings		
Symbol	Definition	Conditions	min.	typ.	max.	Unit
$V_{RSM}$	max. non-repetitive reverse blocking voltage				900	V
$V_{RRM}$	max. repetitive reverse blocking voltage				800	V
$I_R$	reverse current	$V_R = 800\text{ V}$	$T_{VJ} = 25^\circ\text{C}$		100	$\mu\text{A}$
		$V_R = 800\text{ V}$	$T_{VJ} = 150^\circ\text{C}$		1.5	mA
$V_F$	forward voltage drop	$I_F = 40\text{ A}$	$T_{VJ} = 25^\circ\text{C}$		1.14	V
					1.32	V
		$I_F = 80\text{ A}$	$T_{VJ} = 125^\circ\text{C}$		1.06	V
					1.29	V
$I_{DAV}$	bridge output current	$T_C = 115^\circ\text{C}$ rectangular $d = 0.5$	$T_{VJ} = 150^\circ\text{C}$		80	A
$V_{F0}$	threshold voltage	} for power loss calculation only	$T_{VJ} = 150^\circ\text{C}$		0.81	V
$r_F$	slope resistance				5.9	m $\Omega$
$R_{thJC}$	thermal resistance junction to case				0.7	K/W
$R_{thCH}$	thermal resistance case to heatsink			0.3		K/W
$P_{tot}$	total power dissipation		$T_C = 25^\circ\text{C}$		175	W
$I_{FSM}$	max. forward surge current	$t = 10\text{ ms}; (50\text{ Hz}), \text{ sine}$	$T_{VJ} = 45^\circ\text{C}$		750	A
		$t = 8,3\text{ ms}; (60\text{ Hz}), \text{ sine}$	$V_R = 0\text{ V}$		810	A
		$t = 10\text{ ms}; (50\text{ Hz}), \text{ sine}$	$T_{VJ} = 150^\circ\text{C}$		640	A
		$t = 8,3\text{ ms}; (60\text{ Hz}), \text{ sine}$	$V_R = 0\text{ V}$		690	A
$I^2t$	value for fusing	$t = 10\text{ ms}; (50\text{ Hz}), \text{ sine}$	$T_{VJ} = 45^\circ\text{C}$		2.82	kA <sup>2</sup> s
		$t = 8,3\text{ ms}; (60\text{ Hz}), \text{ sine}$	$V_R = 0\text{ V}$		2.73	kA <sup>2</sup> s
		$t = 10\text{ ms}; (50\text{ Hz}), \text{ sine}$	$T_{VJ} = 150^\circ\text{C}$		2.05	kA <sup>2</sup> s
		$t = 8,3\text{ ms}; (60\text{ Hz}), \text{ sine}$	$V_R = 0\text{ V}$		1.98	kA <sup>2</sup> s
$C_J$	junction capacitance	$V_R = 400\text{ V}; f = 1\text{ MHz}$	$T_{VJ} = 25^\circ\text{C}$		11	pF



# VBO78-08NO7

Package ECO-PAC2				Ratings			
Symbol	Definition	Conditions	min.	typ.	max.	Unit	
$I_{RMS}$	RMS current	per terminal			100	A	
$T_{stg}$	storage temperature		-40		125	°C	
$T_{vj}$	virtual junction temperature		-40		150	°C	
<b>Weight</b>				24		g	
$M_D$	mounting torque		1.5		2	Nm	
$d_{Spp/App}$	creepage distance on surface   striking distance through air	terminal to terminal	6.0			mm	
$d_{Spb/Apb}$		terminal to backside	10.0			mm	
$V_{ISOL}$	isolation voltage	t = 1 second	3000			V	
		t = 1 minute	2500			V	

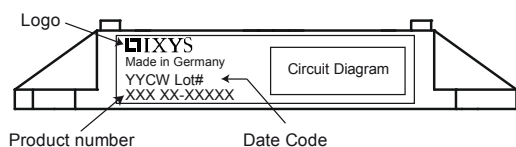

Ordering	Part Number	Marking on Product	Delivery Mode	Quantity	Code No.
Standard	VBO78-08NO7	VBO78-08NO7	Box	25	494313

## Equivalent Circuits for Simulation

\* on die level

$T_{vj} = 150^\circ\text{C}$

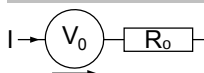

Rectifier

$V_{0\max}$	threshold voltage	0.81	V
$R_{0\max}$	slope resistance *	4.6	mΩ

Outlines ECO-PAC2

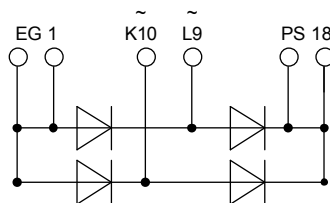
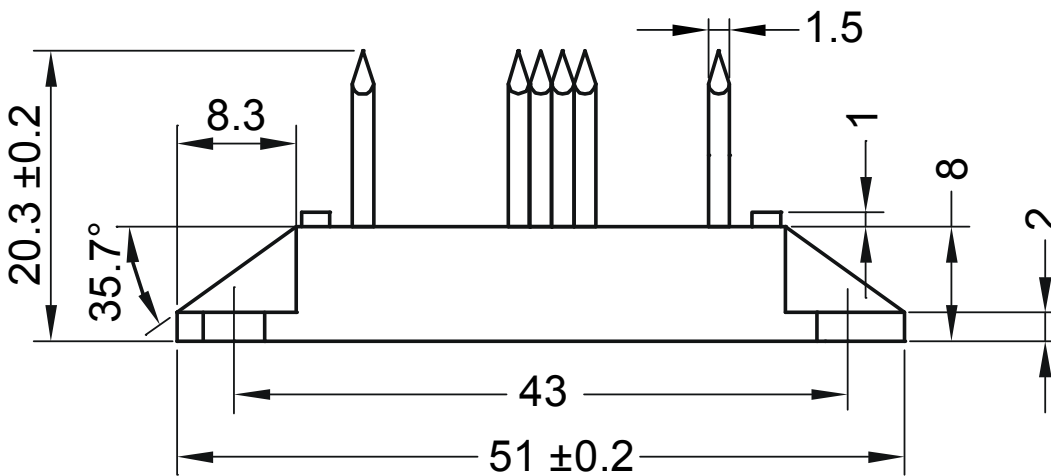
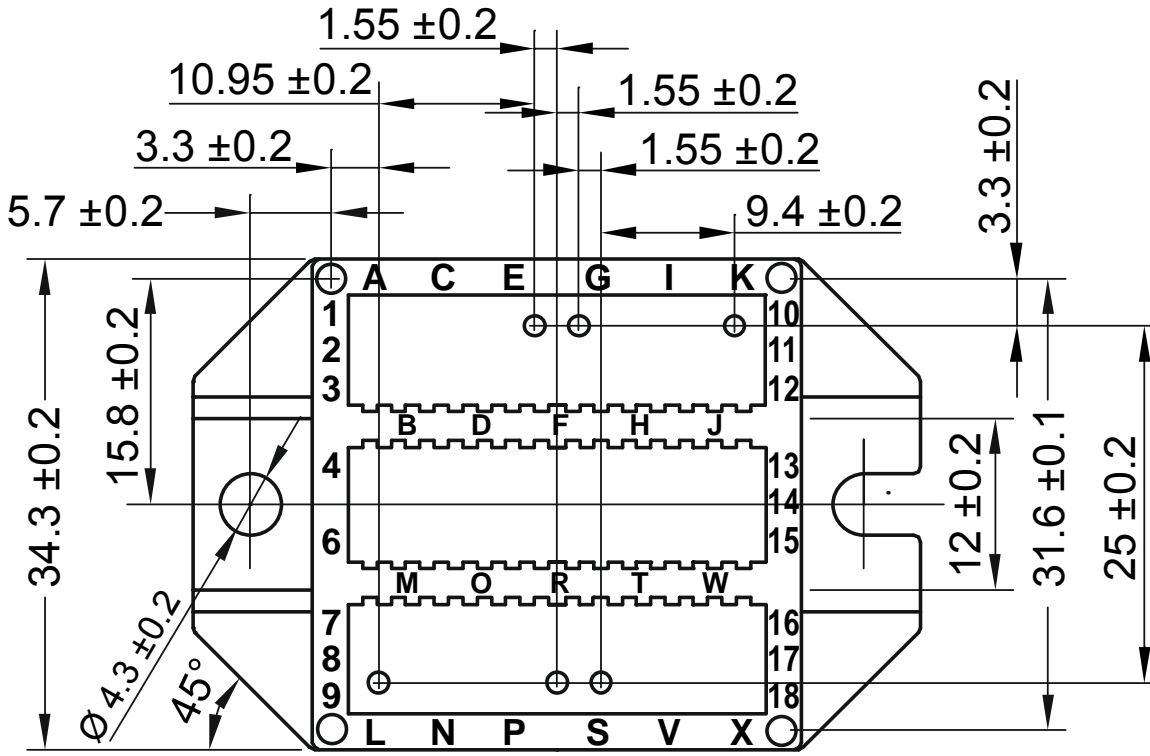

**Rectifier**

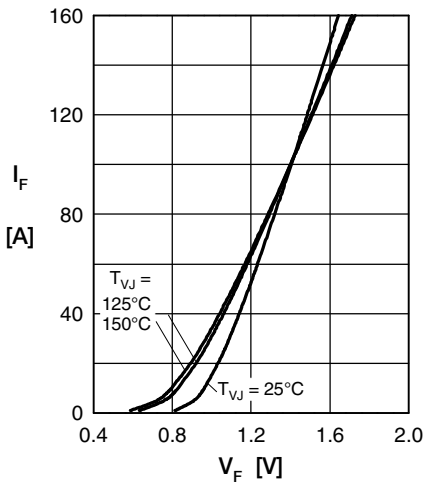

Fig. 1 Forward current versus voltage drop per diode

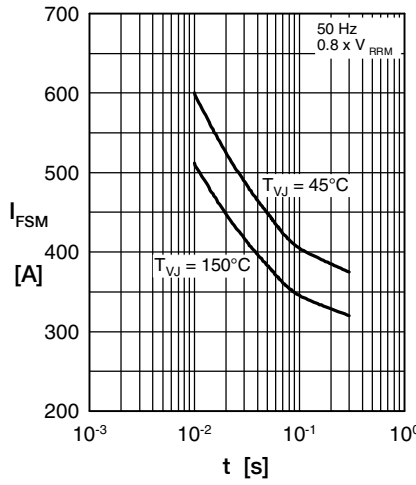

Fig. 2 Surge overload current

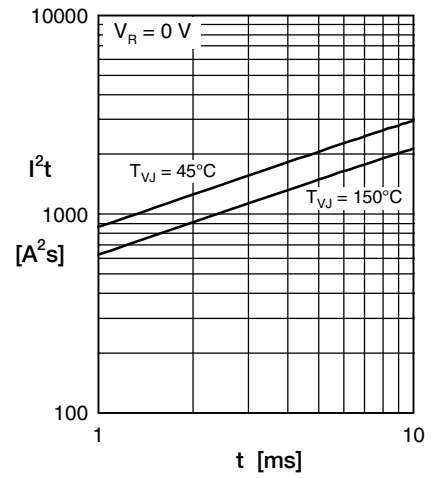

Fig. 3 I<sup>2</sup>t versus time per diode

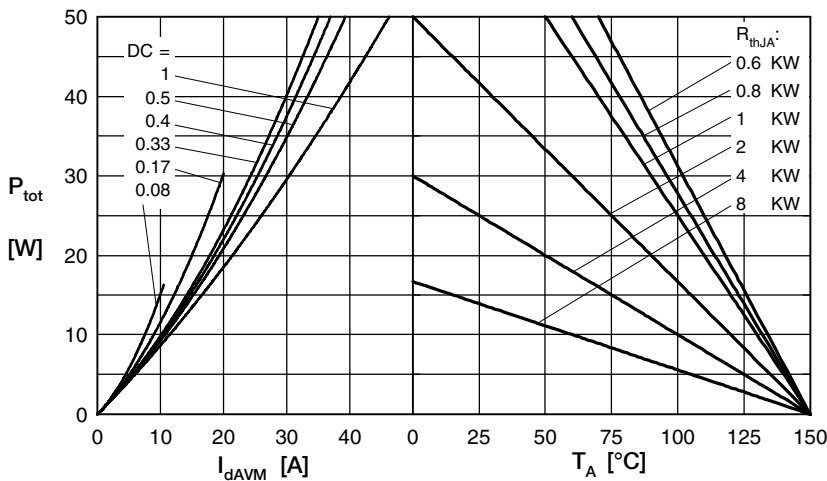

Fig. 4 Power dissipation vs. direct output current & ambient temperature

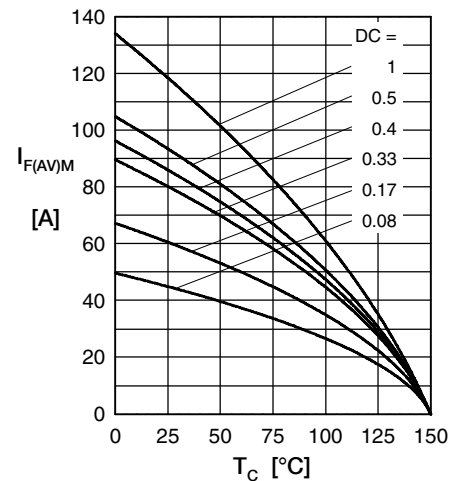

Fig. 5 Max. forward current vs. case temperature

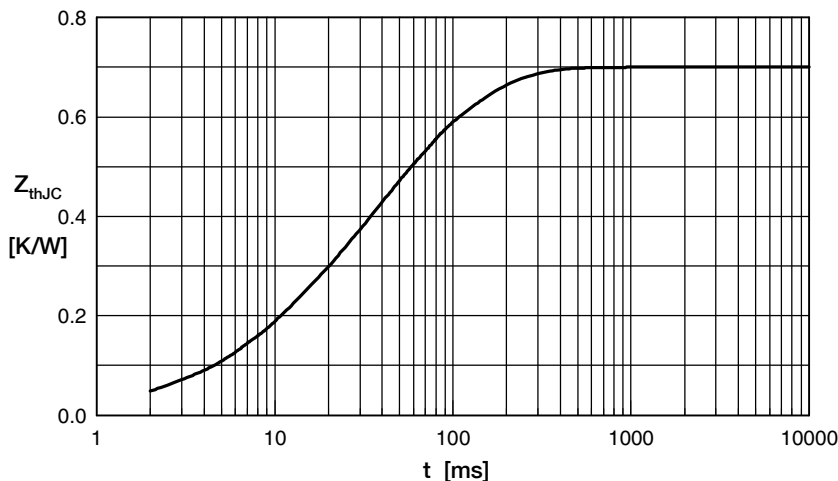

Fig. 6 Transient thermal impedance junction to case

Constants for  $Z_{thJC}$  calculation:

i	$R_{th}$ (K/W)	$t_i$ (s)
1	0.09	0.012
2	0.05	0.007
3	0.32	0.036
4	0.24	0.102