

## Excellent Integrated System Limited

Stocking Distributor

Click to view price, real time Inventory, Delivery & Lifecycle Information:

[STMicroelectronics](#)  
[STPS10170CG-TR](#)

For any questions, you can email us directly:

[sales@integrated-circuit.com](mailto:sales@integrated-circuit.com)



# STPS10170C

## High voltage power Schottky rectifier

Datasheet – production data

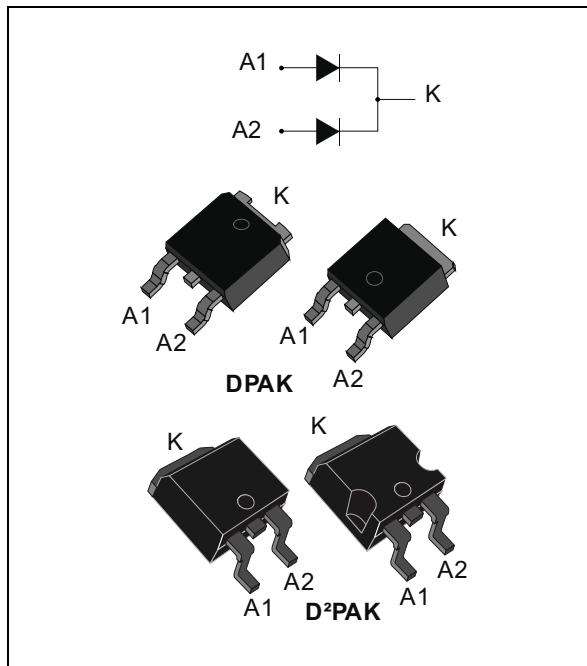

### Description

This dual center tab Schottky rectifier is suited for high frequency switched mode power supplies.

**Table 1. Device summary**

Symbol	Value
$I_{F(AV)}$	2 x 5 A
$V_{RRM}$	170 V
$T_{j(max)}$	175 °C
$V_F (Typ)$	0.69 V

### Features

- High junction temperature capability
- Good trade off between leakage current and forward voltage drop
- Low leakage current
- Avalanche capability specified
- ECOPACK<sup>®</sup>2 compliant component for DPAK and D<sup>2</sup>PAK on demand

Characteristics

STPS10170C

# 1 Characteristics

**Table 2. Absolute ratings (limiting values per diode at T<sub>amb</sub> = 25 °C unless otherwise stated)**

Symbol	Parameter		Value	Unit	
V <sub>RRM</sub>	Repetitive peak reverse voltage		170	V	
I <sub>F(RMS)</sub>	Forward rms current		10	A	
I <sub>F(AV)</sub>	Average forward current, δ = 0.5, square wave	T <sub>C</sub> = 155 °C	Per diode	5	A
			Total	10	
I <sub>FSM</sub>	Surge non repetitive forward current	t <sub>p</sub> = 10 ms sinusoidal	75	A	
P <sub>ARM</sub> <sup>(1)</sup>	Repetitive peak avalanche power	t <sub>p</sub> = 10 μs, T <sub>j</sub> = 125 °C	220	W	
T <sub>stg</sub>	Storage temperature range		-65 to + 175	°C	
T <sub>j</sub>	Maximum operating junction temperature <sup>(2)</sup>		175	°C	

- For pulse time duration derating, please refer to [Figure 3](#). More details regarding the avalanche energy measurements and diode validation in the avalanche are provided in the application notes AN1768 and AN2025.
- $\frac{dP_{tot}}{dT_j} < \frac{1}{R_{th(j-a)}}$  condition to avoid thermal runaway for a diode on its own heatsink

**Table 3. Thermal parameters**

Symbol	Parameter		Value	Unit
R <sub>th(j-c)</sub>	Junction to case	Per diode	4	°C/W
		Total	2.4	
R <sub>th(c)</sub>	Coupling		0.7	

When the diodes 1 and 2 are used simultaneously:

$$\Delta T_j(\text{diode 1}) = P(\text{diode1}) \times R_{th(j-c)}(\text{Per diode}) + P(\text{diode 2}) \times R_{th(c)}$$

**Table 4. Static electrical characteristics (per diode)**

Symbol	Parameter	Test conditions		Min.	Typ	Max.	Unit
I <sub>R</sub> <sup>(1)</sup>	Reverse leakage current	T <sub>j</sub> = 25 °C	V <sub>R</sub> = V <sub>RRM</sub>	-	-	10	μA
		T <sub>j</sub> = 125 °C		-	-	10	mA
V <sub>F</sub> <sup>(2)</sup>	Forward voltage drop	T <sub>j</sub> = 25 °C	I <sub>F</sub> = 5 A	-	-	0.92	V
		T <sub>j</sub> = 125 °C		-	0.69	0.75	
		T <sub>j</sub> = 25 °C	I <sub>F</sub> = 10 A	-	-	1.0	
		T <sub>j</sub> = 125 °C		-	0.79	0.85	

- Pulse test: t<sub>p</sub> = 5 ms, δ < 2%
- Pulse test: t<sub>p</sub> = 380 μs, δ < 2%

To evaluate the conduction losses use the following equation:

$$P = 0.65 \times I_{F(AV)} + 0.02 \times I_{F(RMS)}^2$$

**STPS10170C**

**Characteristics**

**Figure 1. Average forward power dissipation versus average forward current (per diode)**

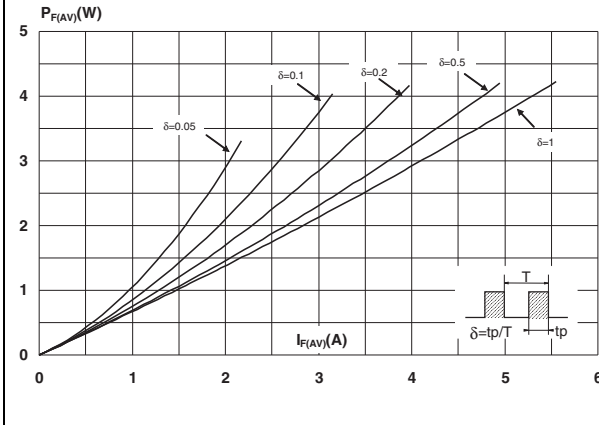

**Figure 2. Average forward current per diode versus ambient temperature ( $\delta = 0.5$ )**

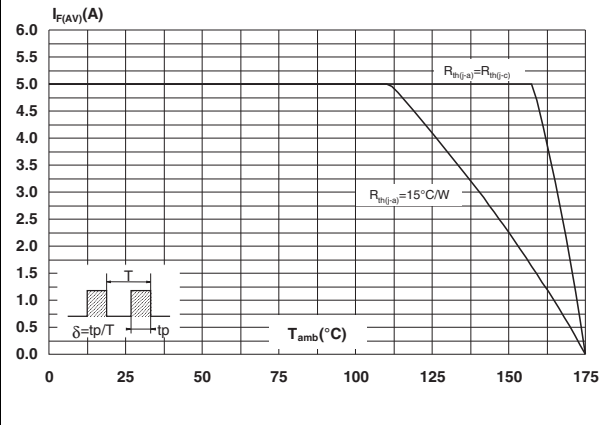

**Figure 3. Normalized avalanche power derating versus pulse duration at  $T_j = 125^\circ\text{C}$**

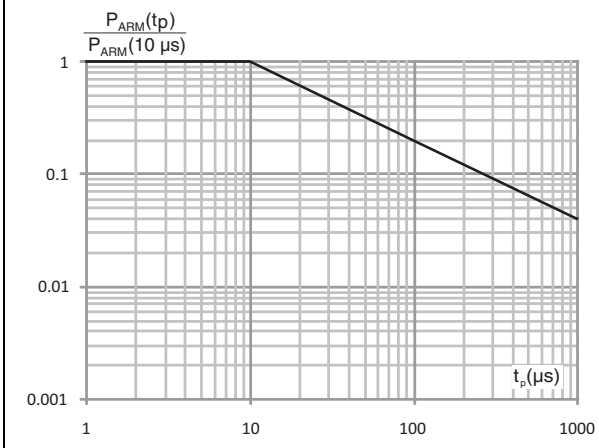

**Figure 4. Relative variation of thermal impedance junction to case versus pulse duration**

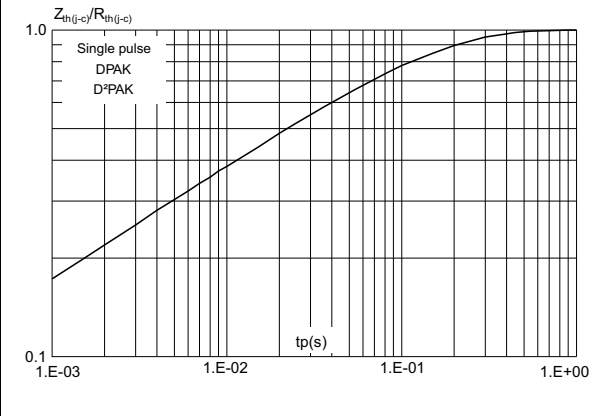

**Figure 5. Reverse leakage current versus reverse voltage applied (typical values, per diode)**

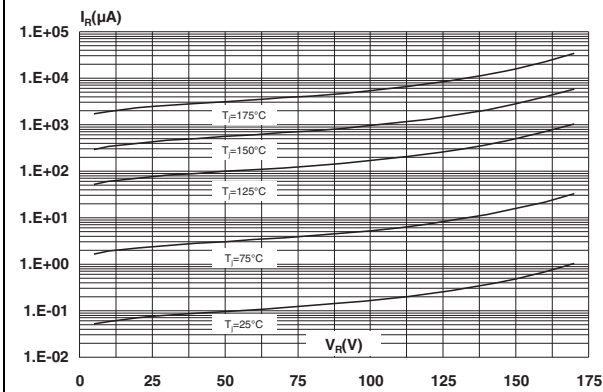

**Figure 6. Junction capacitance versus reverse voltage applied (typical values, per diode)**

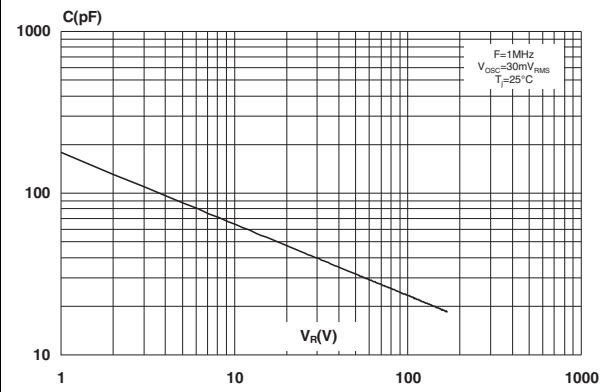

**Characteristics**

**STPS10170C**

**Figure 7. Forward voltage drop vs. forward current (per diode)**

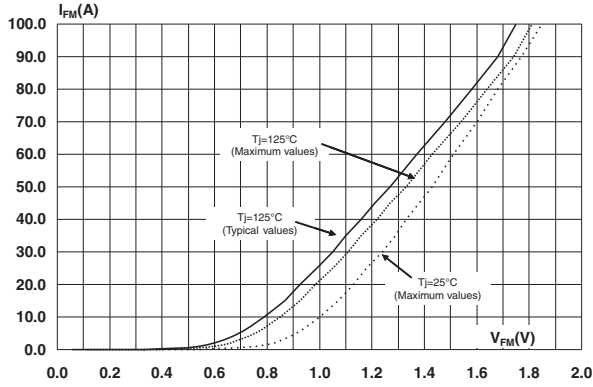

**Figure 8. Thermal resistance junction to ambient versus copper surface under tab (DPAK)**

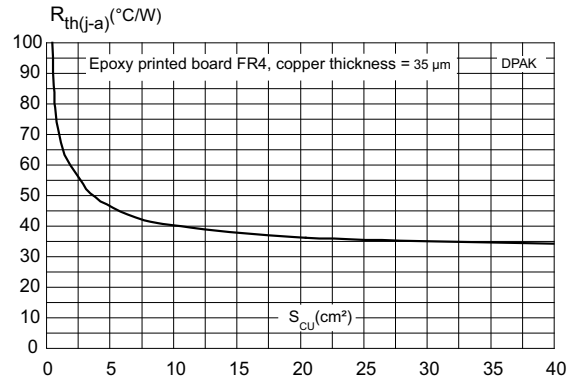

**Figure 9. Thermal resistance junction to ambient versus copper surface under tab (D<sup>2</sup>PAK)**

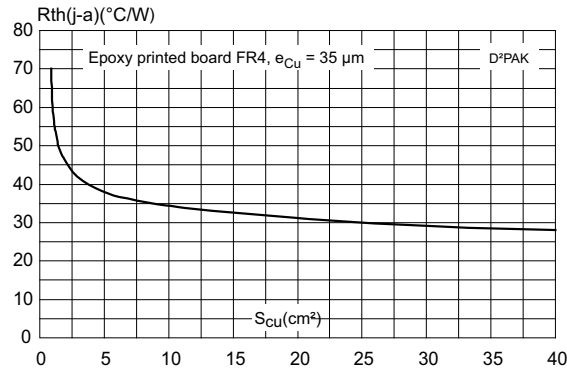

## 2 Package Information

- Epoxy meets UL94,V0
- Cooling method: by conduction (C)

In order to meet environmental requirements, ST offers these devices in different grades of ECOPACK® packages, depending on their level of environmental compliance. ECOPACK® specifications, grade definitions and product status are available at: [www.st.com](http://www.st.com). ECOPACK® is an ST trademark.

### 2.1 DPAK package information

Figure 10. DPAK package outline

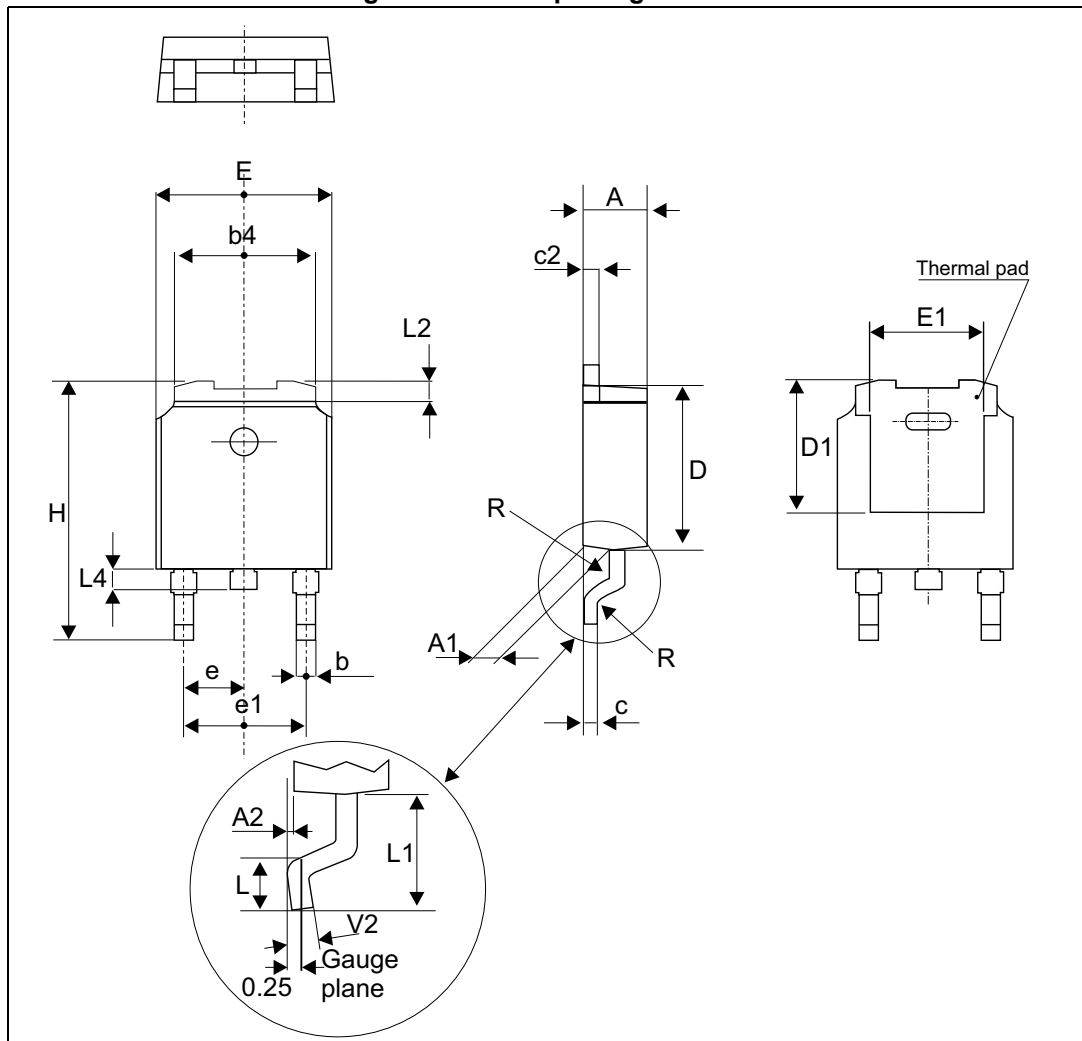

*Note:* This package drawing may slightly differ from the physical package. However, all the specified dimensions are guaranteed.

Package Information

STPS10170C

Table 5. DPAK package mechanical data

Ref.	Dimensions					
	Millimeters			Inches		
	Min.	Typ.	Max.	Min.	Typ.	Max.
A	2.18		2.40	0.085		0.094
A1	0.90		1.10	0.035		0.043
A2	0.03		0.23	0.001		0.009
b	0.64		0.90	0.025		0.035
b4	4.95		5.46	0.194		0.214
c	0.46		0.61	0.018		0.024
c2	0.46		0.60	0.018		0.023
D	5.97		6.22	0.235		0.244
D1	4.95		5.60	0.194		0.220
E	6.35		6.73	0.250		0.264
E1	4.32		5.50	0.170		0.216
e		2.28			0.090	
e1	4.40		4.70	0.173		0.185
H	9.35		10.40	0.368		0.409
L	1.00		1.78	0.039		0.070
L2			1.27			0.050
L4	0.60		1.02	0.023		0.040
V2	-8°		+8°	-8°		8°

Figure 11. DPAK footprint dimensions (in mm)

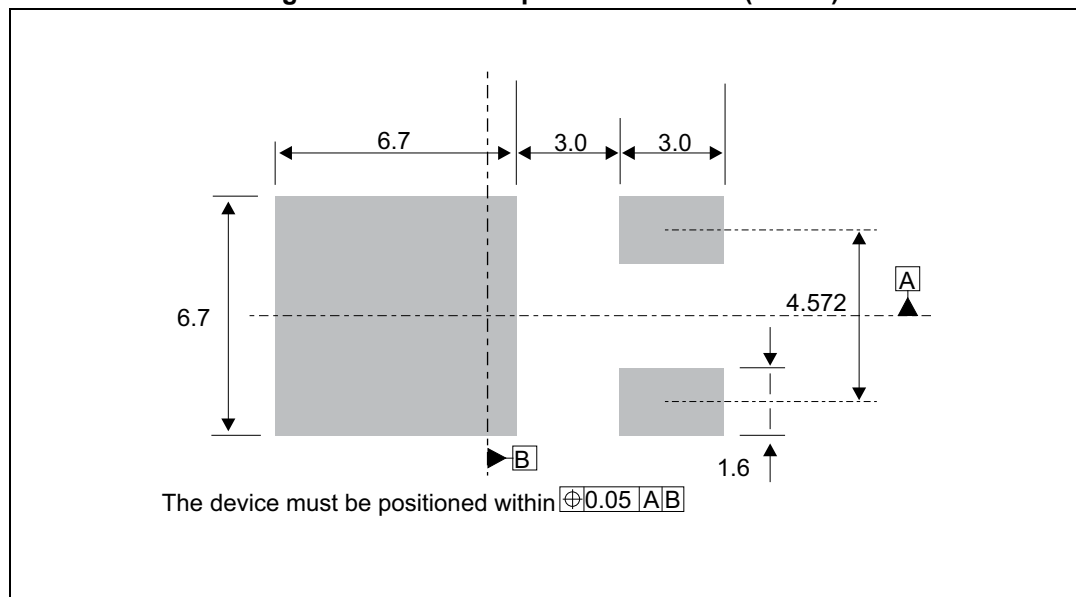

## 2.2 D<sup>2</sup>PAK package information

Figure 12. D<sup>2</sup>PAK package outline

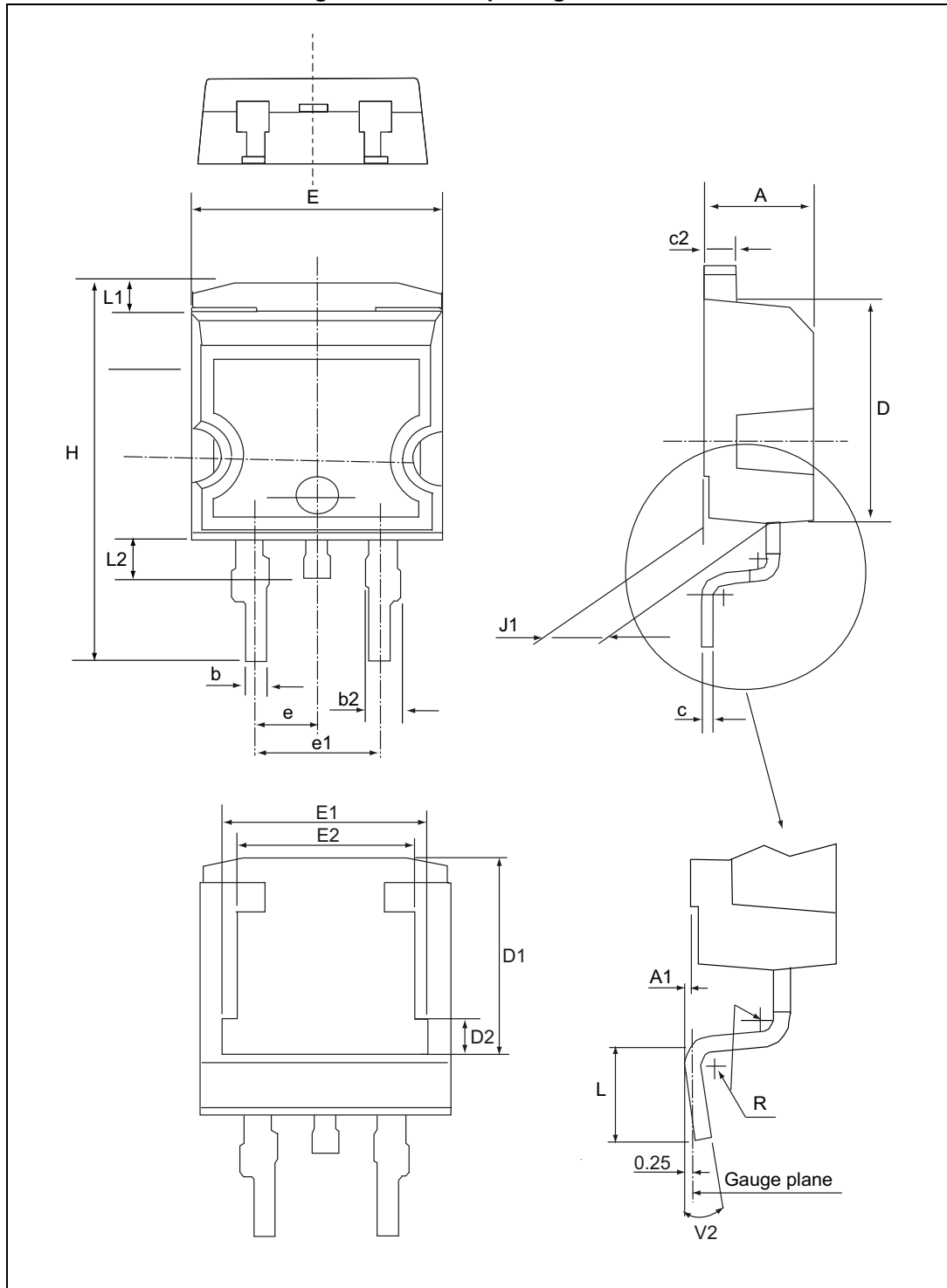

Note: This package drawing may slightly differ from the physical package. However, all the specified dimensions are guaranteed.



Package Information

STPS10170C

Table 6. D<sup>2</sup>PAK package mechanical data

Ref.	Dimensions					
	Millimeters			Inches		
	Min.	Typ.	Max.	Min.	Typ.	Max.
A	4.36		4.60	0.171		0.181
A1	0		0.25			0.010
b	0.70		0.93	0.027		0.037
b2	1.14		1.70	0.045		0.067
c	0.38		0.69	0.014		0.027
c2	1.19		1.36	0.046		0.053
D	8.60		9.35	0.338		0.368
D1	6.90		8.00	0.271		0.315
D2	1.10		1.50	0.043		0.060
E	10.00		10.55	0.393		0.415
E1	8.10		8.90	0.318		0.350
E2	6.85		7.25	0.269		0.285
e		2.54			0.1	
e1	4.88		5.28	0.192		0.208
H	15.00		15.85	0.590		0.624
J1	2.49		2.90	0.098		0.114
L	1.90		2.79	0.074		0.110
L1	1.27		1.65	0.050		0.065
L2	1.30		1.78	0.051		0.070
R		0.40 typ.		0.016 typ.		
V2	0°		8°	0°		8°

Figure 13. Footprint (dimensions in mm)

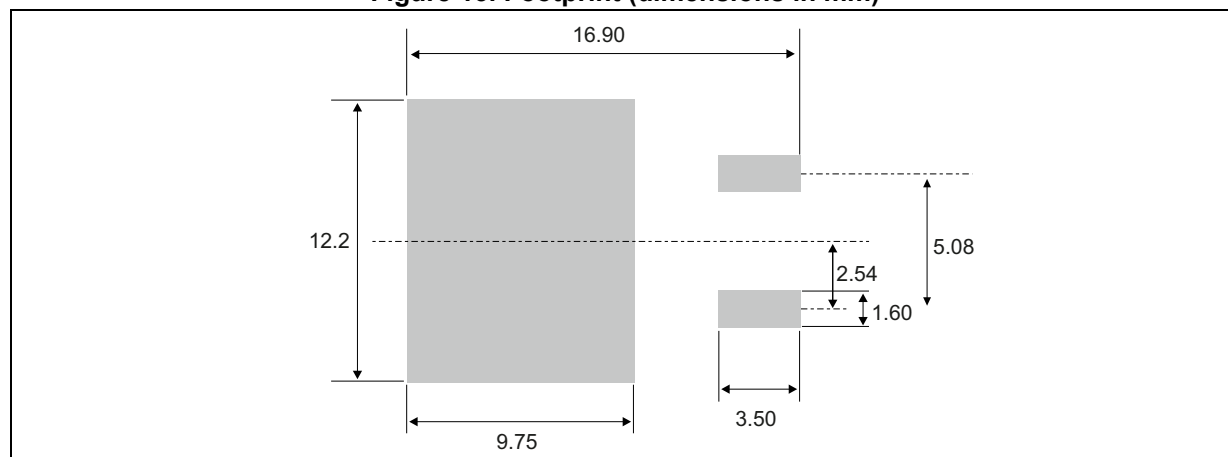

### 3 Ordering information

Table 7. Ordering information

Order code	Marking	Package	Weight	Base qty	Delivery mode
STPS10170CG-TR	STPS10170CG	D <sup>2</sup> PAK	1.38 g	1000	Tape and reel
STPS10170CB-TR	PS10170CB	DPAK	0.32 g	2500	

### 4 Revision history

Table 8. Revision history

Date	Revision	Changes
13-Jul-2006	1	First issue.
09-Jan-2015	2	Updated DPAK and D <sup>2</sup> PAK and reformatted to current standard.
23-Apr-2015	3	Updated Figure 12 and reformatted to current standard.
18-Dec-2015	4	Updated DPAK package information and reformatted to current standard.

**IMPORTANT NOTICE – PLEASE READ CAREFULLY**

STMicroelectronics NV and its subsidiaries (“ST”) reserve the right to make changes, corrections, enhancements, modifications, and improvements to ST products and/or to this document at any time without notice. Purchasers should obtain the latest relevant information on ST products before placing orders. ST products are sold pursuant to ST’s terms and conditions of sale in place at the time of order acknowledgement.

Purchasers are solely responsible for the choice, selection, and use of ST products and ST assumes no liability for application assistance or the design of Purchasers’ products.

No license, express or implied, to any intellectual property right is granted by ST herein.

Resale of ST products with provisions different from the information set forth herein shall void any warranty granted by ST for such product.

ST and the ST logo are trademarks of ST. All other product or service names are the property of their respective owners.

Information in this document supersedes and replaces information previously supplied in any prior versions of this document.

© 2015 STMicroelectronics – All rights reserved