

## Excellent Integrated System Limited

Stocking Distributor

Click to view price, real time Inventory, Delivery & Lifecycle Information:

[Comchip Technology](#)

[CDBUR40](#)

For any questions, you can email us directly:

[sales@integrated-circuit.com](mailto:sales@integrated-circuit.com)

# SMD Schottky Barrier Diode



## CDBUR40(RoHs Device)

$I_o = 200 \text{ mA}$   
 $V_R = 40 \text{ Volts}$

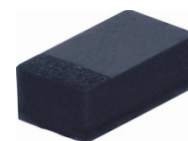

### Features

- Low forward voltage.
- Designed for mounting on small surface.
- Extremely thin / leadless package.
- Majority carrier conduction.

### Mechanical data

- Case: 0603(1608) standard package, molded plastic.
- Terminals: Gold plated, solderable per MIL-STD-750, method 2026.
- Polarity: Indicated by cathode band.
- Marking code: BC
- Mounting position: Any
- Weight: 0.003 gram(approx.).

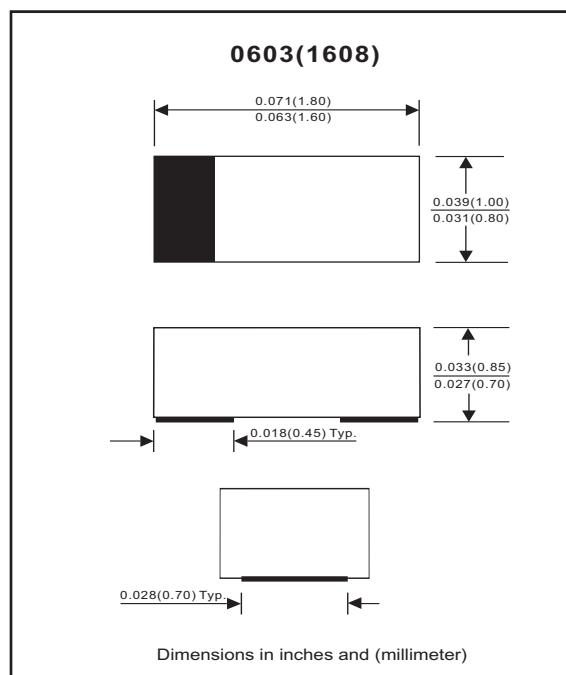

### Maximum Rating (at $T_A=25^\circ\text{C}$ unless otherwise noted)

Parameter	Conditions	Symbol	Min	Typ	Max	Unit
Peak reverse voltage		$V_{RM}$			40	V
Reverse voltage		$V_R$			40	V
RMS reverse voltage		$V_{R(RMS)}$			28	V
Average forward rectified current		$I_o$			200	mA
Forward current, surge peak	8.3 ms single half sine-wave superimposed on rate load(JEDEC method)	$I_{FSM}$			0.6	A
Power dissipation		$P_D$			150	mW
Storage temperature		$T_{STG}$	-65		+125	$^\circ\text{C}$
Junction temperature		$T_j$			+125	$^\circ\text{C}$

### Electrical Characteristics (at $T_A=25^\circ\text{C}$ unless otherwise noted)

Parameter	Conditions	Symbol	Min	Typ	Max	Unit
Forward voltage	$I_F = 1 \text{ mA}$ $I_F = 40 \text{ mA}$	$V_F$			0.38 1	V
Reverse current	$V_R = 30 \text{ V}$	$I_R$			0.2	$\mu\text{A}$
Capacitance between terminals	$f = 1 \text{ MHz}$ , and 0 VDC reverse voltage	$C_T$			5	pF
Reverse recovery time	$I_F=I_R=10 \text{ mA}$ , $I_{rr}=0.1 \times I_R$ , $R_L=100 \text{ ohm}$	$T_{rr}$			5	nS

# SMD Schottky Barrier Diode



## RATING AND CHARACTERISTIC CURVES (CDBUR40)

Fig. 1 - Forward characteristics

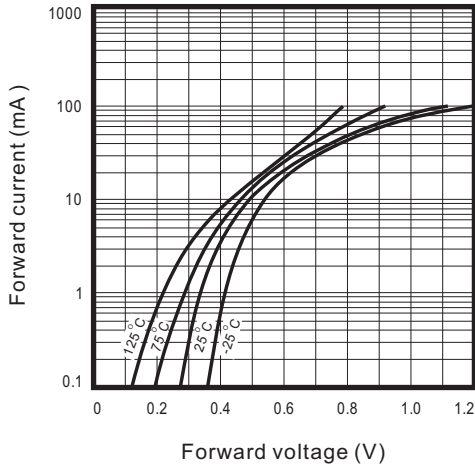

Fig. 2 - Reverse characteristics

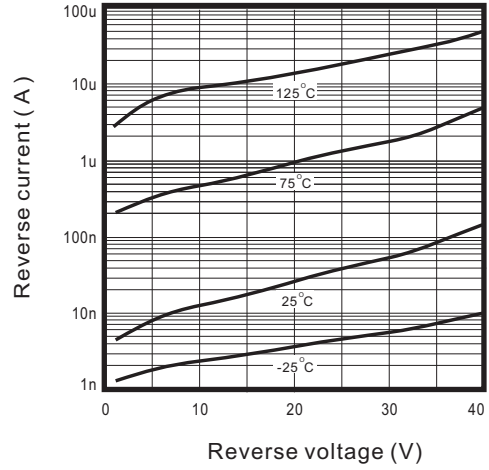

Fig.3 - Capacitance between terminals characteristics

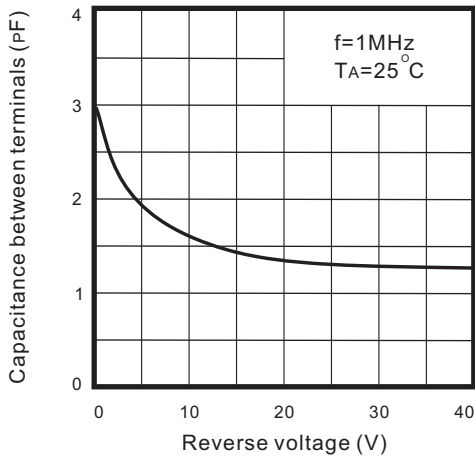
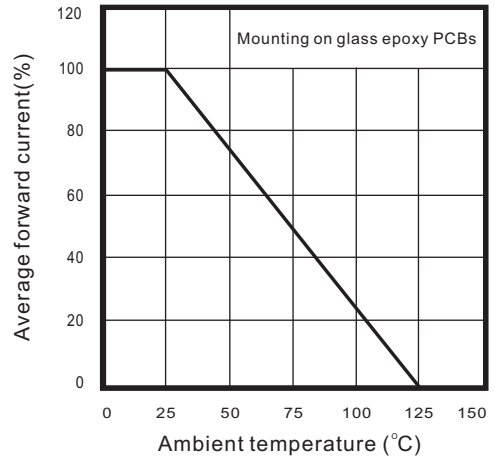

Fig.4 - Current derating curve



# SMD Schottky Barrier Diode



## Reel Taping Specification

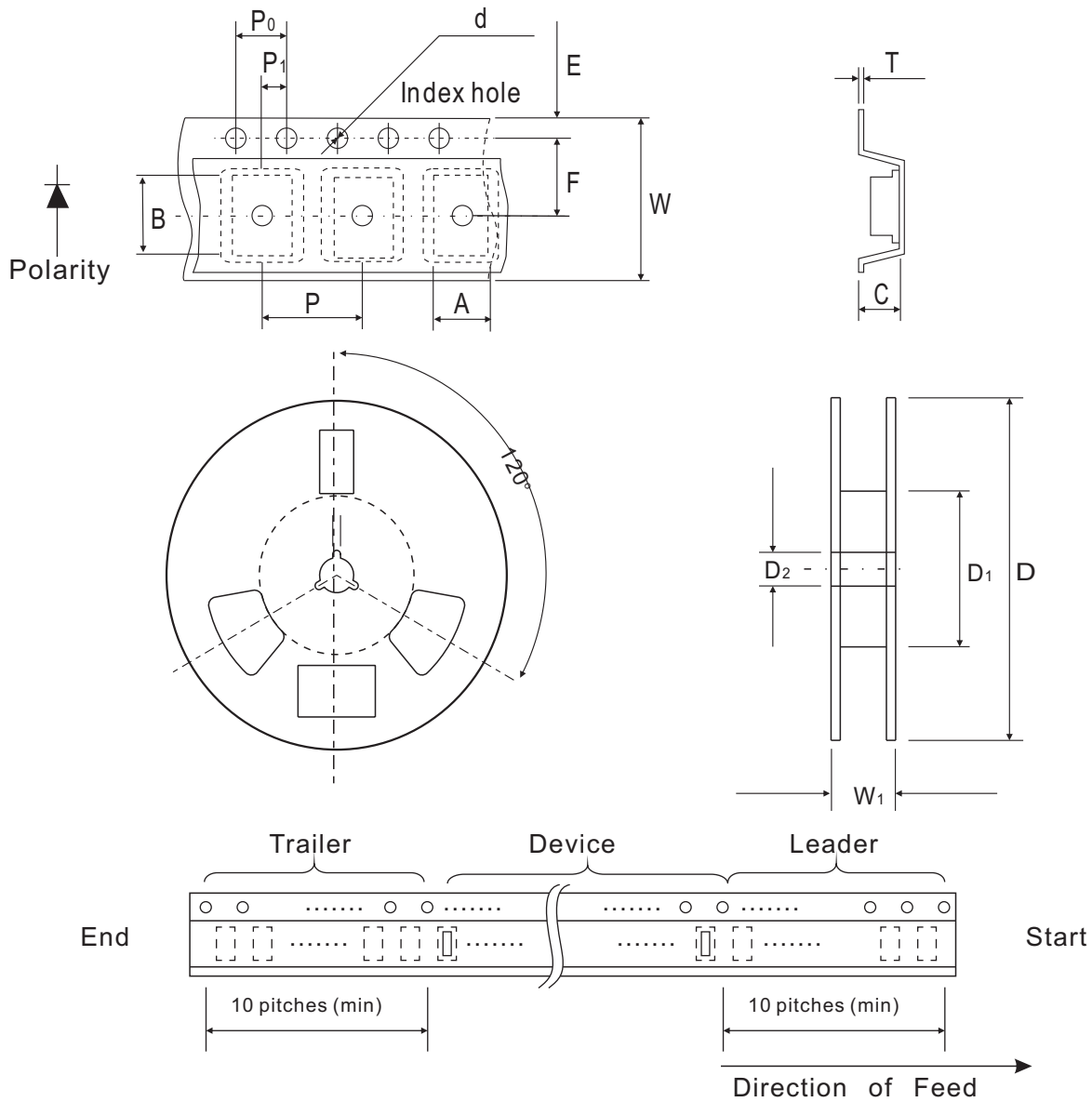

UR/0603	SYMBOL	A	B	C	d	D	D <sub>1</sub>	D <sub>2</sub>
	(mm)	1.00 ± 0.10	1.85 ± 0.10	1.00 ± 0.10	1.55 ± 0.05	178 ± 1	60.0 MIN.	13.0 ± 0.20
	(inch)	0.039 ± 0.004	0.073 ± 0.004	0.039 ± 0.004	0.061 ± 0.002	7.008 ± 0.04	2.362 MIN.	0.512 ± 0.008

UR/0603	SYMBOL	E	F	P	P <sub>0</sub>	P <sub>1</sub>	T	W	W <sub>1</sub>
	(mm)	1.75 ± 0.10	3.50 ± 0.05	4.00 ± 0.10	4.00 ± 0.10	2.00 ± 0.05	0.23 ± 0.05	8.00 ± 0.20	13.5 MAX.
	(inch)	0.069 ± 0.004	0.138 ± 0.002	0.157 ± 0.004	0.157 ± 0.004	0.079 ± 0.004	0.009 ± 0.002	0.315 ± 0.008	0.531 MAX.

# SMD Schottky Barrier Diode



## Marking Code

Part Number	Marking Code
CDBUR40	BC



## Suggested PAD Layout

SIZE	UR/0603	
	(mm)	(inch)
A	1.25	0.049
B	0.60	0.024
C	1.00	0.039
D	1.85	0.073
E	0.65	0.026

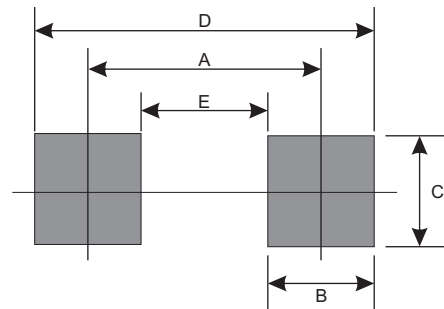

## Standard Package

Case Type	Qty per Reel	Reel Size
	(Pcs)	(inch)
UR/0603	4000	7