

## Excellent Integrated System Limited

Stocking Distributor

Click to view price, real time Inventory, Delivery & Lifecycle Information:

[Vishay Semiconductor/Opto Division](#)  
[BPV10](#)

For any questions, you can email us directly:

[sales@integrated-circuit.com](mailto:sales@integrated-circuit.com)



www.vishay.com

**BPV10**

Vishay Semiconductors

## Silicon PIN Photodiode

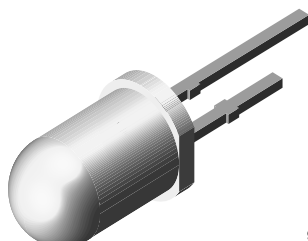

94 8390



**RoHS**  
COMPLIANT  
**GREEN**  
(5-2008)\*\*

### FEATURES

- Package type: leaded
- Package form: T-1 $\frac{3}{4}$
- Dimensions (in mm):  $\varnothing$  5
- Leads with stand-off
- Radiant sensitive area (in mm<sup>2</sup>): 0.78
- High photo sensitivity
- High radiant sensitivity
- Suitable for visible and near infrared radiation
- High bandwidth: 250 MHz at  $V_R = 12$  V
- Fast response times
- Angle of half sensitivity:  $\varphi = \pm 20^\circ$
- Compliant to RoHS Directive 2002/95/EC and in accordance with WEEE 2002/96/EC

### Note

\*\* Please see document "Vishay Material Category Policy":  
[www.vishay.com/doc?99902](http://www.vishay.com/doc?99902)

### APPLICATIONS

- High speed photo detector

### DESCRIPTION

BPV10 is a PIN photodiode with high speed and high radiant sensitivity in clear, T-1 $\frac{3}{4}$  plastic package. It is sensitive to visible and near infrared radiation.

PRODUCT SUMMARY			
COMPONENT	$I_{ra}$ ( $\mu$ A)	$\varphi$ (deg)	$\lambda_{0.1}$ (nm)
BPV10	70	$\pm 20$	380 to 1100

### Note

- Test condition see table "Basic Characteristics"

ORDERING INFORMATION			
ORDERING CODE	PACKAGING	REMARKS	PACKAGE FORM
BPV10	Bulk	MOQ: 4000 pcs, 4000 pcs/bulk	T-1 $\frac{3}{4}$

### Note

- MOQ: minimum order quantity

ABSOLUTE MAXIMUM RATINGS ( $T_{amb} = 25$ °C, unless otherwise specified)				
PARAMETER	TEST CONDITION	SYMBOL	VALUE	UNIT
Reverse voltage		$V_R$	60	V
Power dissipation	$T_{amb} \leq 25$ °C	$P_V$	215	mW
Junction temperature		$T_j$	100	°C
Operating temperature range		$T_{amb}$	- 40 to + 100	°C
Storage temperature range		$T_{stg}$	- 40 to + 100	°C
Soldering temperature	$t \leq 5$ s, 2 mm from body	$T_{sd}$	260	°C
Thermal resistance junction/ambient	Connected with Cu wire, 0.14 mm <sup>2</sup>	$R_{thJA}$	350	K/W



www.vishay.com

**BPV10**

Vishay Semiconductors

<b>BASIC CHARACTERISTICS</b> ( $T_{amb} = 25\text{ }^{\circ}\text{C}$ , unless otherwise specified)						
PARAMETER	TEST CONDITION	SYMBOL	MIN.	TYP.	MAX.	UNIT
Forward voltage	$I_F = 50\text{ mA}$	$V_F$		1.0	1.3	V
Breakdown voltage	$I_R = 100\text{ }\mu\text{A}$ , $E = 0$	$V_{(BR)}$	60			V
Reverse dark current	$V_R = 20\text{ V}$ , $E = 0$	$I_{ro}$		1	5	nA
Diode capacitance	$V_R = 0\text{ V}$ , $f = 1\text{ MHz}$ , $E = 0$	$C_D$		11		pF
	$V_R = 5\text{ V}$ , $f = 1\text{ MHz}$ , $E = 0$	$C_D$		3.8		pF
Open circuit voltage	$E_A = 1\text{ klx}$	$V_O$		480		mV
	$E_e = 1\text{ mW/cm}^2$ , $\lambda = 950\text{ nm}$	$V_O$		450		mV
Short circuit current	$E_A = 1\text{ klx}$	$I_K$		80		$\mu\text{A}$
	$E_e = 1\text{ mW/cm}^2$ , $\lambda = 950\text{ nm}$	$I_K$		65		$\mu\text{A}$
Reverse light current	$E_A = 1\text{ klx}$ , $V_R = 5\text{ V}$	$I_{ra}$		85		$\mu\text{A}$
	$E_e = 1\text{ mW/cm}^2$ , $\lambda = 950\text{ nm}$ , $V_R = 5\text{ V}$	$I_{ra}$	38	70		$\mu\text{A}$
Absolute spectral sensitivity	$V_R = 5\text{ V}$ , $\lambda = 950\text{ nm}$	$s(\lambda)$		0.55		A/W
Angle of half sensitivity		$\varphi$		$\pm 20$		deg
Wavelength of peak sensitivity		$\lambda_p$		920		nm
Range of spectral bandwidth		$\lambda_{0.1}$		380 to 1100		nm
Quantum efficiency	$\lambda = 950\text{ nm}$	$\eta$		72		%
Noise equivalent power	$V_R = 20\text{ V}$ , $\lambda = 950\text{ nm}$	NEP		$3 \times 10^{-14}$		$\text{W}/\sqrt{\text{Hz}}$
Detectivity	$V_R = 20\text{ V}$ , $\lambda = 950\text{ nm}$	D		$3 \times 10^{12}$		$\text{cm}^2/\text{Hz}/\text{W}$
Rise time	$V_R = 50\text{ V}$ , $R_L = 50\text{ }\Omega$ , $\lambda = 820\text{ nm}$	$t_r$		2.5		ns
Fall time	$V_R = 50\text{ V}$ , $R_L = 50\text{ }\Omega$ , $\lambda = 820\text{ nm}$	$t_f$		2.5		ns

**BASIC CHARACTERISTICS** ( $T_{amb} = 25\text{ }^{\circ}\text{C}$ , unless otherwise specified)

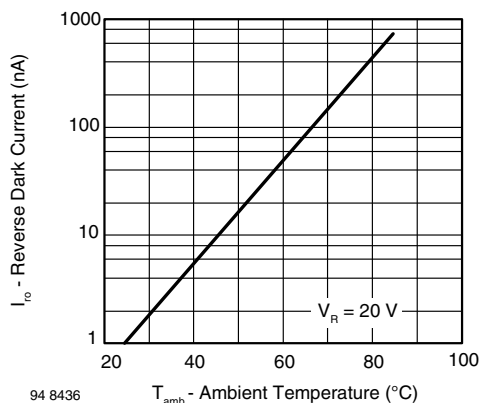

Fig. 1 - Reverse Dark Current vs. Ambient Temperature

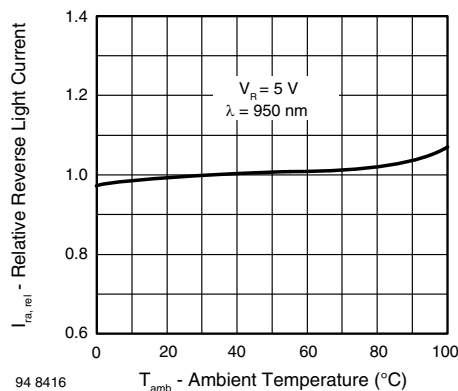

Fig. 2 - Relative Reverse Light Current vs. Ambient Temperature



www.vishay.com

**BPV10**

Vishay Semiconductors

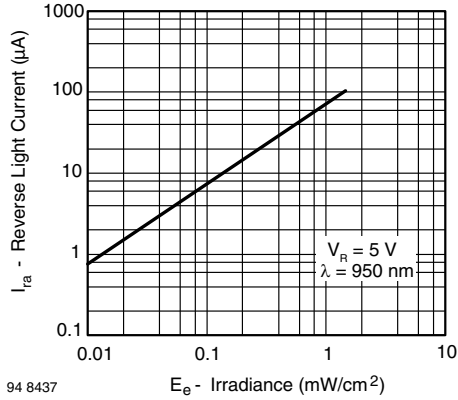

94 8437 Fig. 3 - Reverse Light Current vs. Irradiance

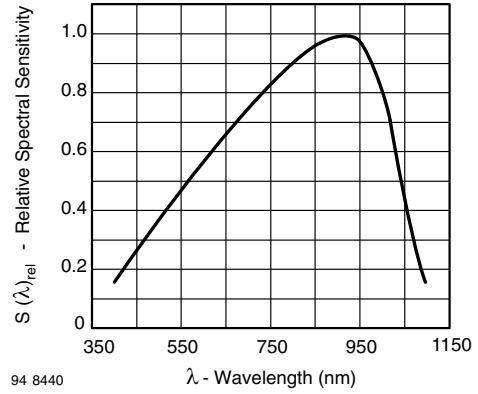

94 8440 Fig. 6 - Relative Spectral Sensitivity vs. Wavelength

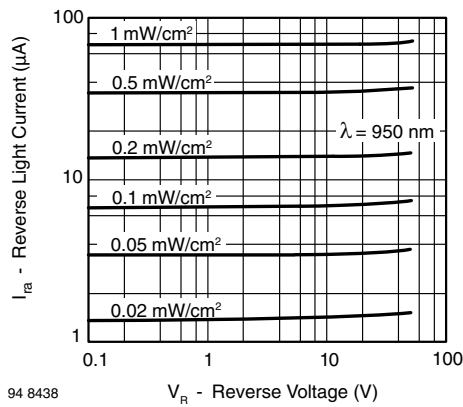

94 8438 Fig. 4 - Reverse Light Current vs. Reverse Voltage

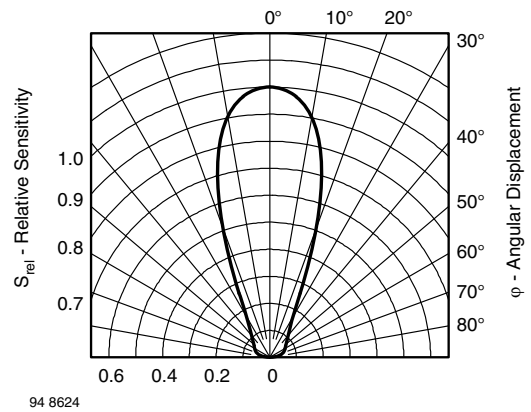

94 8624 Fig. 7 - Relative Radiant Sensitivity vs. Angular Displacement

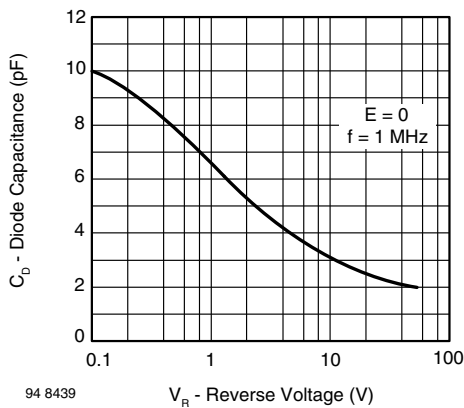

94 8439 Fig. 5 - Diode Capacitance vs. Reverse Voltage



www.vishay.com

**BPV10**

Vishay Semiconductors

**PACKAGE DIMENSIONS** in millimeters

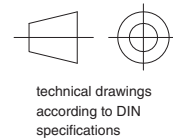
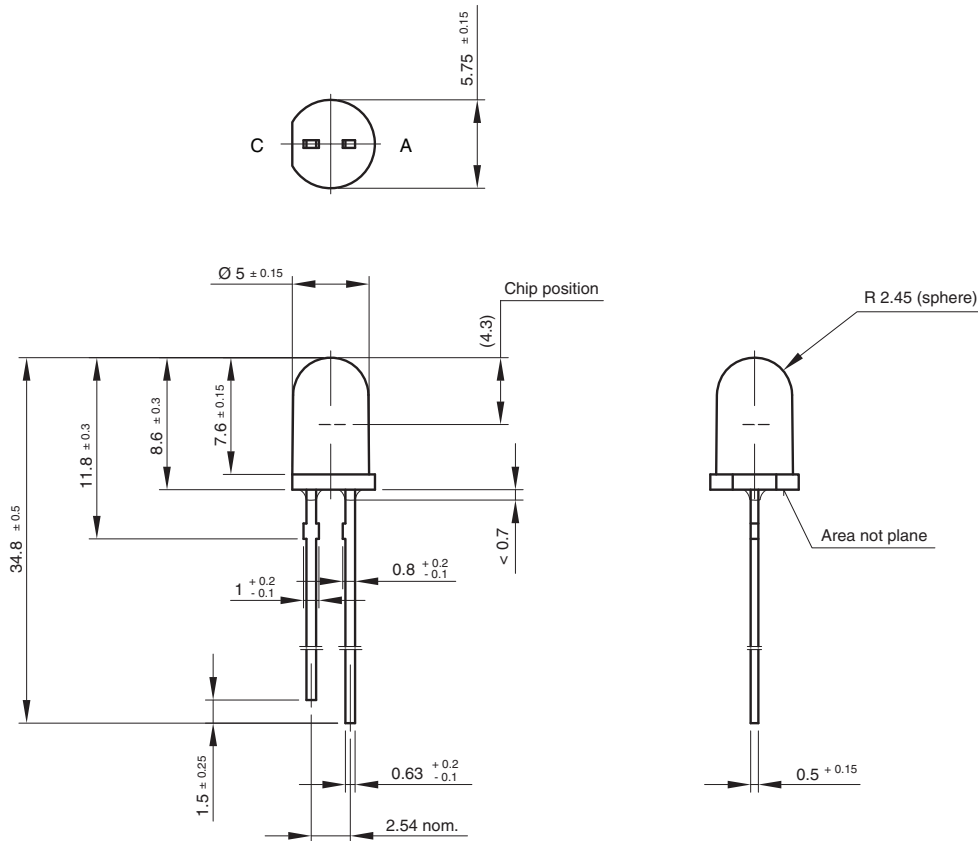

Drawing-No.: 6.544-5185.02-4  
 Issue:1; 01.07.96  
 96 12199



## Disclaimer

ALL PRODUCT, PRODUCT SPECIFICATIONS AND DATA ARE SUBJECT TO CHANGE WITHOUT NOTICE TO IMPROVE RELIABILITY, FUNCTION OR DESIGN OR OTHERWISE.

Vishay Intertechnology, Inc., its affiliates, agents, and employees, and all persons acting on its or their behalf (collectively, "Vishay"), disclaim any and all liability for any errors, inaccuracies or incompleteness contained in any datasheet or in any other disclosure relating to any product.

Vishay makes no warranty, representation or guarantee regarding the suitability of the products for any particular purpose or the continuing production of any product. To the maximum extent permitted by applicable law, Vishay disclaims (i) any and all liability arising out of the application or use of any product, (ii) any and all liability, including without limitation special, consequential or incidental damages, and (iii) any and all implied warranties, including warranties of fitness for particular purpose, non-infringement and merchantability.

Statements regarding the suitability of products for certain types of applications are based on Vishay's knowledge of typical requirements that are often placed on Vishay products in generic applications. Such statements are not binding statements about the suitability of products for a particular application. It is the customer's responsibility to validate that a particular product with the properties described in the product specification is suitable for use in a particular application. Parameters provided in datasheets and / or specifications may vary in different applications and performance may vary over time. All operating parameters, including typical parameters, must be validated for each customer application by the customer's technical experts. Product specifications do not expand or otherwise modify Vishay's terms and conditions of purchase, including but not limited to the warranty expressed therein.

Except as expressly indicated in writing, Vishay products are not designed for use in medical, life-saving, or life-sustaining applications or for any other application in which the failure of the Vishay product could result in personal injury or death. Customers using or selling Vishay products not expressly indicated for use in such applications do so at their own risk. Please contact authorized Vishay personnel to obtain written terms and conditions regarding products designed for such applications.

No license, express or implied, by estoppel or otherwise, to any intellectual property rights is granted by this document or by any conduct of Vishay. Product names and markings noted herein may be trademarks of their respective owners.