

Excellent Integrated System Limited

Stocking Distributor

Click to view price, real time Inventory, Delivery & Lifecycle Information:

[Rohm Semiconductor](#)
[RSS070P05FU6TB](#)

For any questions, you can email us directly:

sales@integrated-circuit.com

RSS070P05

Transistor

4V Drive Pch MOS FET

RSS070P05

●Structure

Silicon P-channel
 MOS FET

●Features

- 1) Built-in G-S Protection Diode.
- 2) Small and Surface Mount Package (SOP8).

●Applications

Power switching , DC / DC converter , Inverter

●External dimensions (Unit : mm)

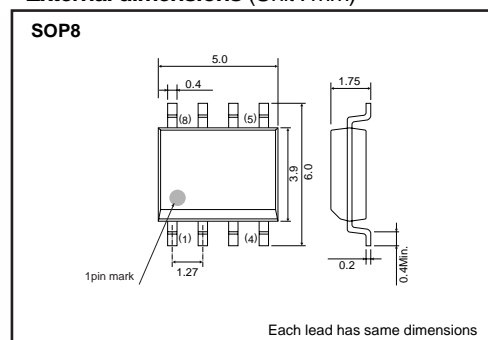

●Packaging dimensions

Type	Package	Taping
	Code	TB
	Basic ordering unit (pieces)	2500
RSS070P05		○

●Absolute maximum ratings (Ta=25°C)

Parameter	Symbol	Limits	Unit
Drain-source voltage	V_{DSS}	-45	V
Gate-source voltage	V_{GSS}	± 20	V
Drain current	Continuous	I_D	± 7.0 A
	Pulsed	I_{DP} *1	± 28 A
Source current (Body diode)	Continuous	I_S	-1.6 A
	Pulsed	I_{SP} *1	-28 A
Total power dissipation	P_D *2	2	W
Chanel temperature	T_{ch}	150	°C
Range of Storage temperature	T_{stg}	-55 to +150	°C

*1 $PW \leq 10\mu s$, Duty cycle $\leq 1\%$

*2 Mounted on a ceramic board

●Equivalent circuit

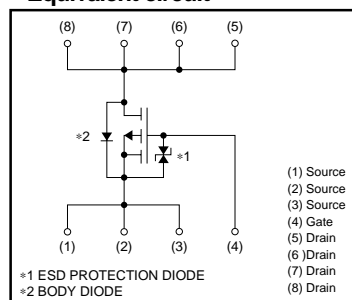

●Thermal resistance

Parameter	Symbol	Limits	Unit
Chanel to ambient	$R_{th(ch-a)}$ *	62.5	°C/W

* Mounted on a ceramic board

RSS070P05

Transistor

●Electrical characteristics (Ta=25°C)

Parameter	Symbol	Min.	Typ.	Max.	Unit	Conditions
Gate-source leakage	I_{GSS}	–	–	±10	μA	$V_{GS}=\pm 20V, V_{DS}=0V$
Drain-source breakdown voltage	$V_{(BR)DSS}$	–45	–	–	V	$I_D=-1mA, V_{GS}=0V$
Zero gate voltage drain current	I_{DSS}	–	–	–1	μA	$V_{DS}=-45V, V_{GS}=0V$
Gate threshold voltage	$V_{GS(th)}$	–1.0	–	–2.5	V	$V_{DS}=-10V, I_D=-1mA$
Static drain-source on-state resistance	$R_{DS(on)}^*$	–	19	27	mΩ	$I_D=-7A, V_{GS}=-10V$
		–	25	35	mΩ	$I_D=-7A, V_{GS}=-4.5V$
		–	28	39	mΩ	$I_D=-7A, V_{GS}=-4.0V$
Forward transfer admittance	$ Y_{fs} ^*$	10.0	–	–	S	$V_{DS}=-10V, I_D=-7A$
Input capacitance	C_{iss}	–	4100	–	pF	$V_{DS}=-10V$
Output capacitance	C_{oss}	–	510	–	pF	$V_{GS}=0V$
Reverse transfer capacitance	C_{rss}	–	330	–	pF	$f=1MHz$
Turn-on delay time	$t_{d(on)}^*$	–	31	–	ns	$V_{DD}=-25V$ $I_D=-3.5A$
Rise time	t_r^*	–	35	–	ns	$V_{GS}=-10V$ $R_L=-7\Omega$
Turn-off delay time	$t_{d(off)}^*$	–	135	–	ns	$R_G=10\Omega$
Fall time	t_f^*	–	50	–	ns	
Total gate charge	Q_g^*	–	34.0	47.6	nC	$V_{DD}=-25V, V_{GS}=-5V$
Gate-source charge	Q_{gs}^*	–	9.5	–	nC	$I_D=-7A$
Gate-drain charge	Q_{gd}^*	–	12	–	nC	$R_L=3.5\Omega, R_G=10\Omega$

*Pulsed

Body diode characteristics (Source-Drain)

Parameter	Symbol	Min.	Typ.	Max.	Unit	Conditions
Forward voltage	V_{SD}^*	–	–	–1.2	V	$I_S=-7A, V_{GS}=0V$

*Pulsed

RSS070P05

Transistor

● **Electrical characteristic curves**

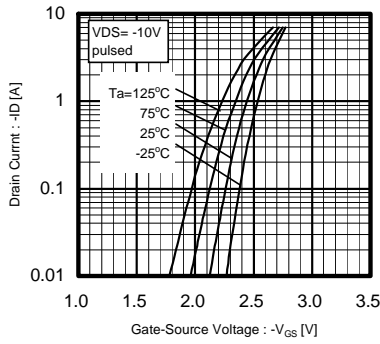

Fig.1 Typical Transfer Characteristics

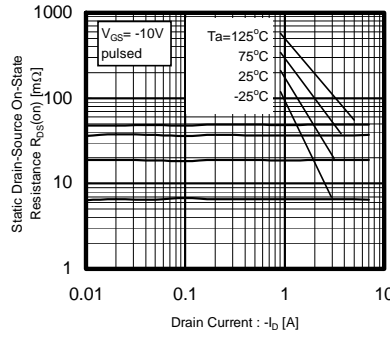

Fig.2 Static Drain-Source On-State Resistance vs. Drain Current (1)

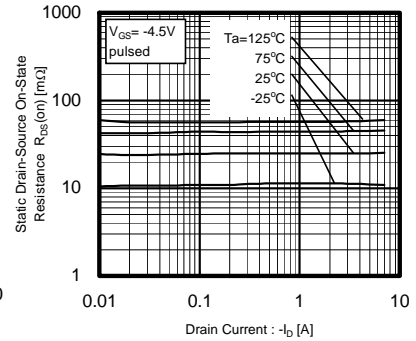

Fig.3 Static Drain-Source On-State Resistance vs. Drain Current (2)

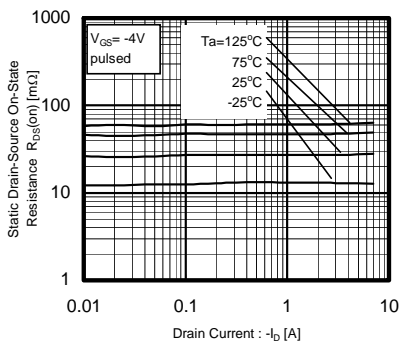

Fig.4 Static Drain-Source On-State Resistance vs. Drain Current (3)

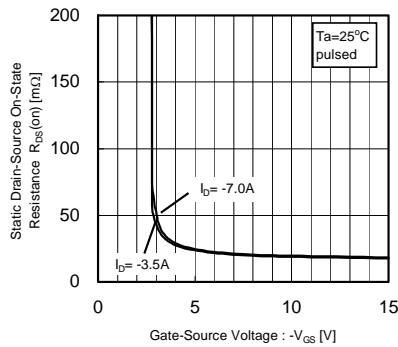

Fig.5 Static Drain-Source On-State Resistance vs. Gate-Source Voltage

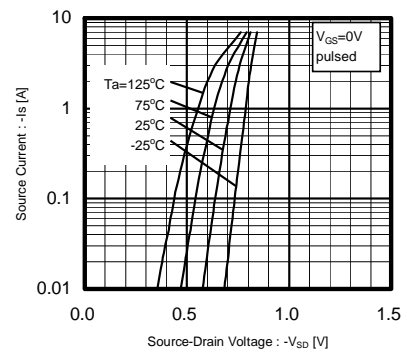

Fig.6 Source-Current vs. Source-Drain Voltage

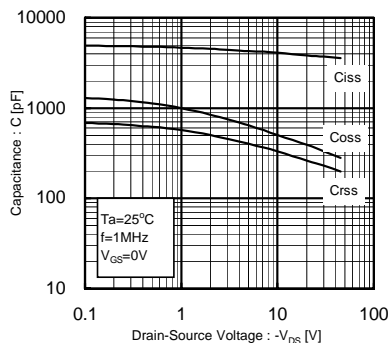

Fig.7 Typical capacitance vs. Source-Drain Voltage

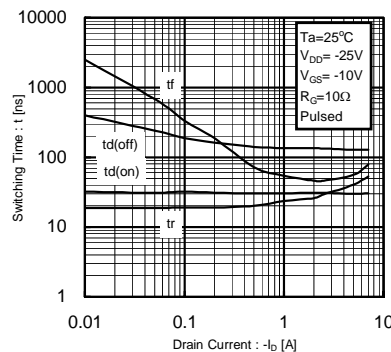

Fig.8 Switching Characteristics

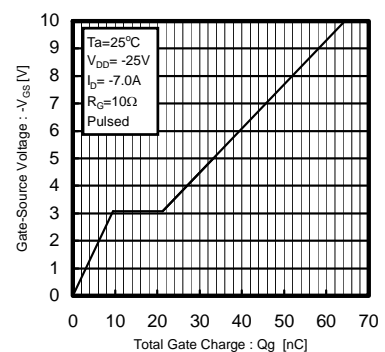

Fig.9 Dynamic Input Characteristics

RSS070P05

Transistor

● **Measurement circuits**

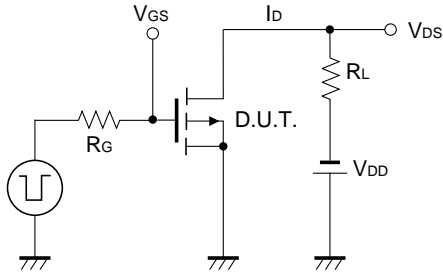

Fig.10 Switching Time Test Circuit

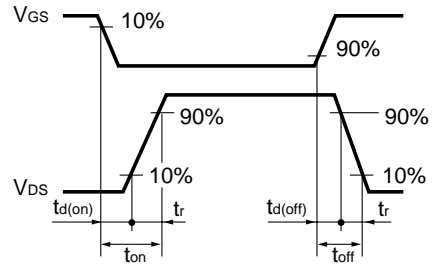

Fig.11 Switching Time Waveforms

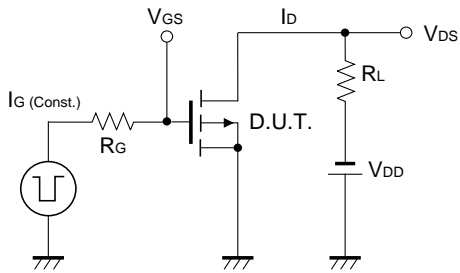

Fig.12 Gate Charge Test Circuit

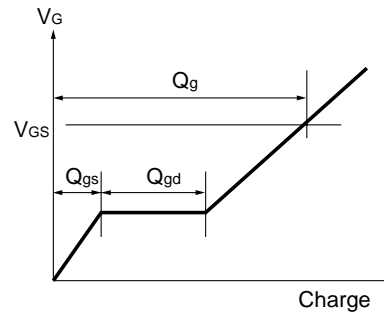

Fig.13 Gate Charge Waveform

Appendix

Notes

- No technical content pages of this document may be reproduced in any form or transmitted by any means without prior permission of ROHM CO.,LTD.
- The contents described herein are subject to change without notice. The specifications for the product described in this document are for reference only. Upon actual use, therefore, please request that specifications to be separately delivered.
- Application circuit diagrams and circuit constants contained herein are shown as examples of standard use and operation. Please pay careful attention to the peripheral conditions when designing circuits and deciding upon circuit constants in the set.
- Any data, including, but not limited to application circuit diagrams information, described herein are intended only as illustrations of such devices and not as the specifications for such devices. ROHM CO.,LTD. disclaims any warranty that any use of such devices shall be free from infringement of any third party's intellectual property rights or other proprietary rights, and further, assumes no liability of whatsoever nature in the event of any such infringement, or arising from or connected with or related to the use of such devices.
- Upon the sale of any such devices, other than for buyer's right to use such devices itself, resell or otherwise dispose of the same, no express or implied right or license to practice or commercially exploit any intellectual property rights or other proprietary rights owned or controlled by
- ROHM CO., LTD. is granted to any such buyer.
- Products listed in this document are no antiradiation design.

The products listed in this document are designed to be used with ordinary electronic equipment or devices (such as audio visual equipment, office-automation equipment, communications devices, electrical appliances and electronic toys).

Should you intend to use these products with equipment or devices which require an extremely high level of reliability and the malfunction of which would directly endanger human life (such as medical instruments, transportation equipment, aerospace machinery, nuclear-reactor controllers, fuel controllers and other safety devices), please be sure to consult with our sales representative in advance.

About Export Control Order in Japan

Products described herein are the objects of controlled goods in Annex 1 (Item 16) of Export Trade Control Order in Japan.

In case of export from Japan, please confirm if it applies to "objective" criteria or an "informed" (by MITI clause) on the basis of "catch all controls for Non-Proliferation of Weapons of Mass Destruction.