

## Excellent Integrated System Limited

Stocking Distributor

Click to view price, real time Inventory, Delivery & Lifecycle Information:

[E-Switch](#)  
[700SP7B20VS3QE](#)

For any questions, you can email us directly:

[sales@integrated-circuit.com](mailto:sales@integrated-circuit.com)

SHEET 1 OF 1

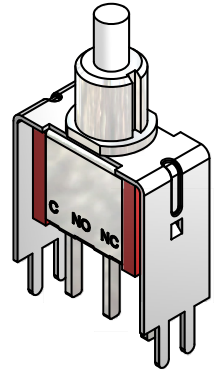
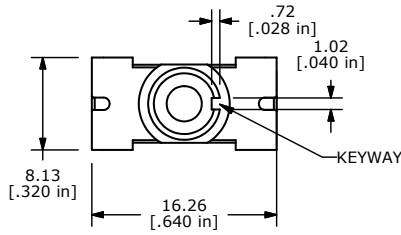
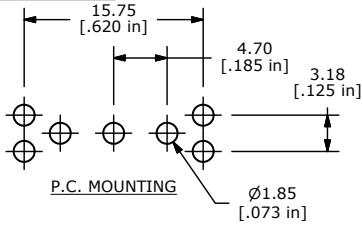

SWITCH FUNCTION	
POS. 1	POS. 2
ON	(ON)
1-3	1-2

(ON)=MOMENTARY

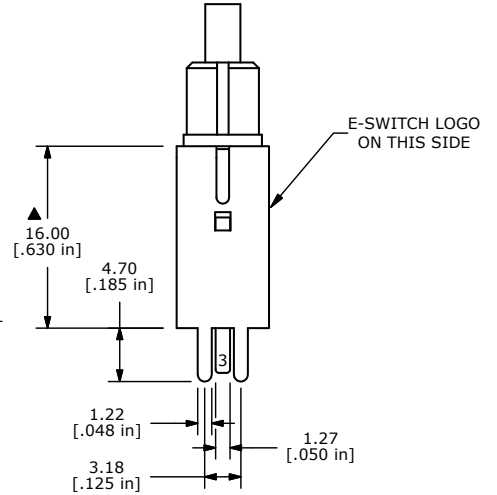
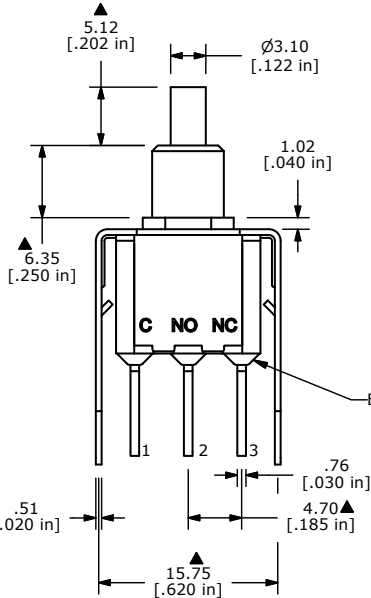
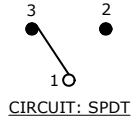

- NOTE:
- ALL DIMENSIONS IN MM [INCH]
  - GENERAL TOLERANCE: X.X=±0.4  
X.XX=±0.25
  - TERMINAL NUMBERS FOR REF ONLY
  - CONTACT MATERIAL: SILVER
  - RATING: 3A @ 120 VAC OR 28 VDC  
1A @ 250 VAC
  - ELECTRIC LIFE: 50,000 MAKE-AND-BREAK CYCLES AT FULL LOAD
  - INSULATION RESISTANCE: 1,000 MEGA-OHM MIN.
  - ACTUATION FORCE: 300 ± 100gf
  - TRAVEL: 1.0 ± 0.2mm
  - CONTACT RESISTANCE: 20 mOHM MAX.  
TYPICAL @ 2-4 VDC
  - DIELECTRIC STRENGTH: 1,000 V RMS @ SEA LEVEL.
  - OPERATING TEMP.: -30°C to 85°C
  - ▲ DENOTES CRITICAL PARAMETER.
  - 2002/95/EC (ROHS) COMPLIANT.



D	20004	DRAWING CLEAN-UP / UPDATE	6/14/11	BGL
REV	PCR NO	DESCRIPTION	DATE	BY

TITLE 700SP7B20VS3QE				
SCALE 2:1	DATE 6/14/2011	DR BGL	DWG T711021	REV D

THE INFORMATION CONTAINED IN THIS DOCUMENT IS PROPRIETARY TO E-SWITCH AND IS NOT TO BE COPIED OR TRANSFERRED