

Excellent Integrated System Limited

Stocking Distributor

Click to view price, real time Inventory, Delivery & Lifecycle Information:

[E-Switch](#)
[KC15A13.001NLS](#)

For any questions, you can email us directly:

sales@integrated-circuit.com

NOTES:

1. ALL DIMENSION IN MM [INCH]
2. GENERAL TOLERANCE: XX=±0.4
XXX=±0.25
3. TERM. NOS. FOR REF. ONLY
4. CONTACT RATING SWITCHING: 150mA, 250V AC/DC
350mA, 110V AC/DC
5. CONTACT RATING (NON-SWITCHING) 5A
6. CONTACT MATERIAL: SILVER over COPPER ALLOY.
7. OPERATING FORCE: 425±100 CM/STANDARD
8. OPERATING TEMP: -30° to 85°C
9. CIRCUIT SP: 5 POSITIONS, 30° INDEX.
10. DIELECTRIC STRENGTH 1000V RMS min. @ SEA LEVEL
11. DESIGNATE MAJOR DIMENSIONS
12. SUPPLIED HARDWARE: LOCK NUT AND WASHER (NOT SHOWN).

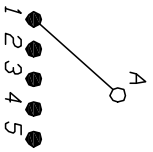

CONTACT CONFIGURATION
 Timing: Non-Shorting (BBM)

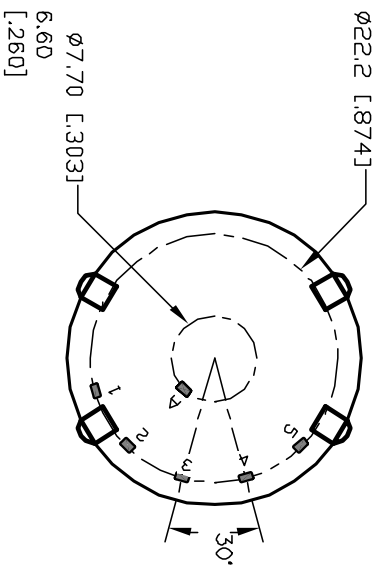
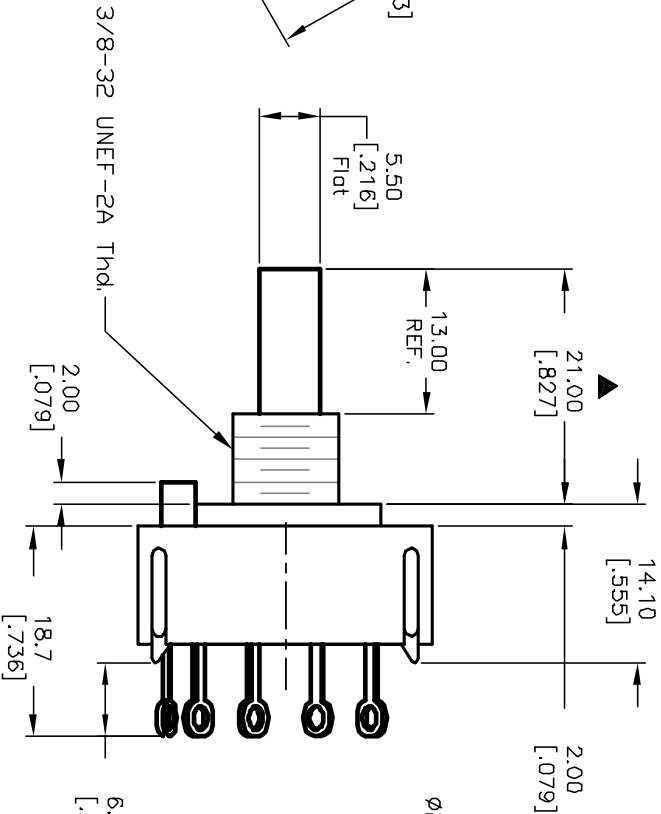
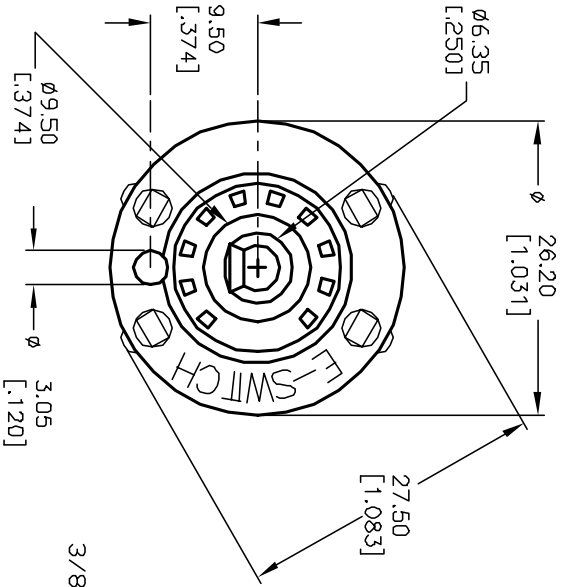
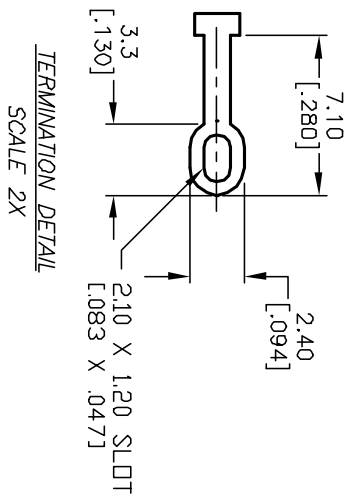

REV.	ECN No.	DESCRIPTION	DATE	CHKD
A	12614	RELEASED FOR PRODUCTION	12/5/02	CJB

TITLE	SCALE	DATE	DR	DWG	REV
KC-15-A (13.0mm) 01-N-L-S	1.5:1	12/5/02	CJB	G527541	A

E-SWITCH®

THE INFORMATION CONTAINED IN THIS DOCUMENT IS PROPRIETARY TO E-SWITCH AND IS NOT TO BE COPIED OR TRANSMITTED