

Excellent Integrated System Limited

Stocking Distributor

Click to view price, real time Inventory, Delivery & Lifecycle Information:

[E-Switch](#)
[KO130Q605](#)

For any questions, you can email us directly:

sales@integrated-circuit.com

SHEET OF

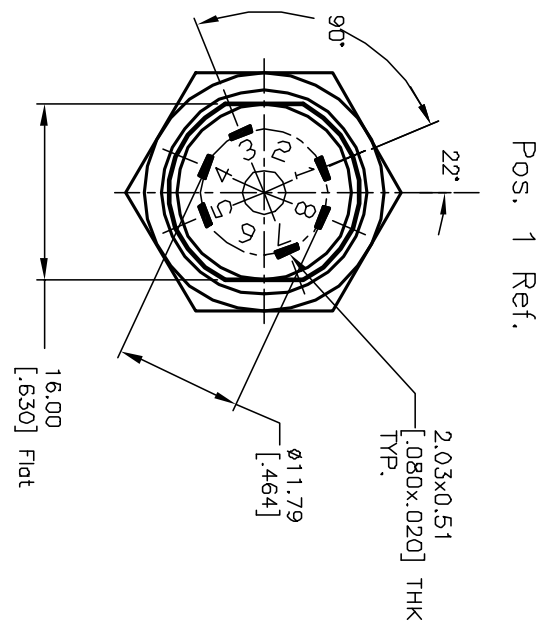
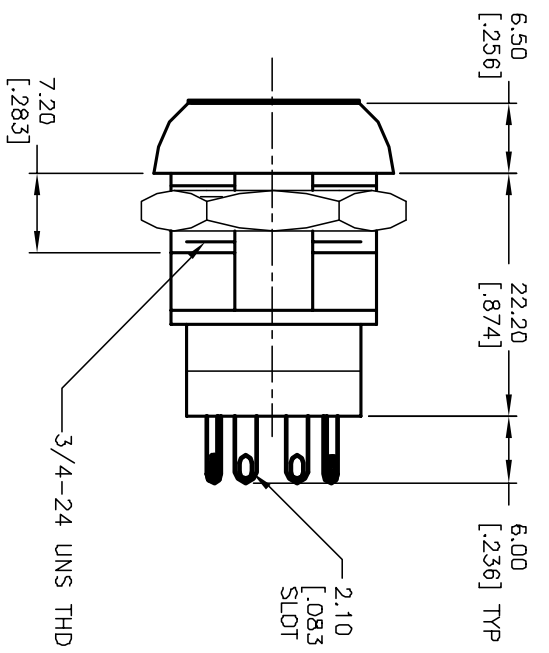
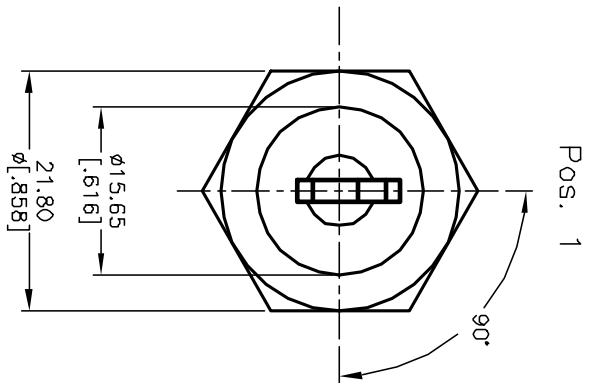

NOTES:

1. ALL DIMENSIONS IN MM [INCH]
2. GENERAL TOLERANCE: X.X=±0.4 X.XX=±0.25
3. TERM. NOS. FOR REF. ONLY
4. CONTACT RATING: 4A @125VAC/28VDC, 2A @250VAC
5. DIELECTRIC STRENGTH: 1KV RMS min. at sea level
6. ELECTRICAL LIFE: 10,000 make-and-break cycles at full load.
7. MATERIALS:
 - CONTACTS: Silver Plated CU (Q Contact material)
 - TERMINALS: GOLD Plated Cu (Q Contact material)
 - MOUNTING NUT: Nickel Plated zinc alloy
 - CONTACT SPRING: Piano Wire
 - KEYS (Z): Brass with code no. 605
 - LOCK: Bright Ni plated zinc alloy with NI facing
 - TUMBLER Mechanism: 4-disc tumbler cylinder.

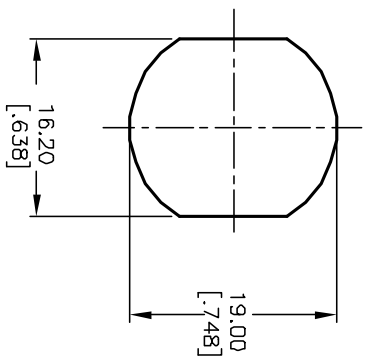

RECOMMENDED PANEL LAYOUT

LEGEND

- =Detent Positions (45° or 90°)
- ⊙ =key pull possible in these positions

CIRCUIT: DP (90° INDEXING) CONTACT CONFIGURATION	
SWITCH FUNCTION	CONNECTED TERMINAL #
POS. 1	POS. 2
8-1, 4-5	1-3, 5-7

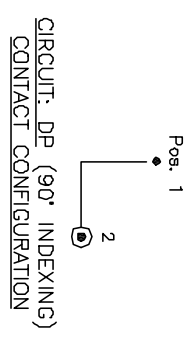

REV.	ECN No.	DESCRIPTION	DATE	CHKD
A	I1714	RELEASED FOR PRODUCTION	10/5/01	CJB

TITLE		SCALE	DATE	DR	DWG	REV
K0130Q-605		1.5:1	10/5/01	CJB	K200265	A

E-SWITCH®

THE INFORMATION CONTAINED IN THIS DOCUMENT IS PROPRIETARY TO E-SWITCH AND IS NOT TO BE COPIED OR TRANSMITTED