

## Excellent Integrated System Limited

Stocking Distributor

Click to view price, real time Inventory, Delivery & Lifecycle Information:

[E-Switch](#)  
[LC2251OANP](#)

For any questions, you can email us directly:

[sales@integrated-circuit.com](mailto:sales@integrated-circuit.com)

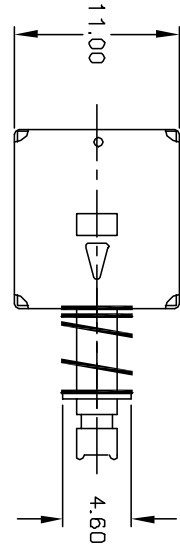

TOP VIEW

SIDE VIEW

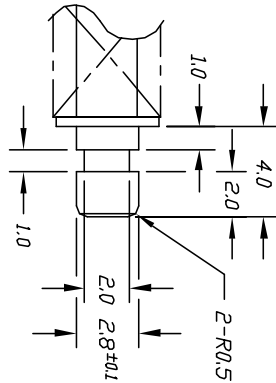
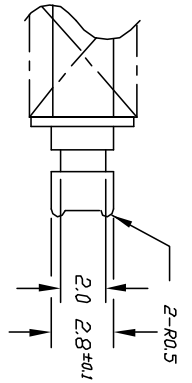
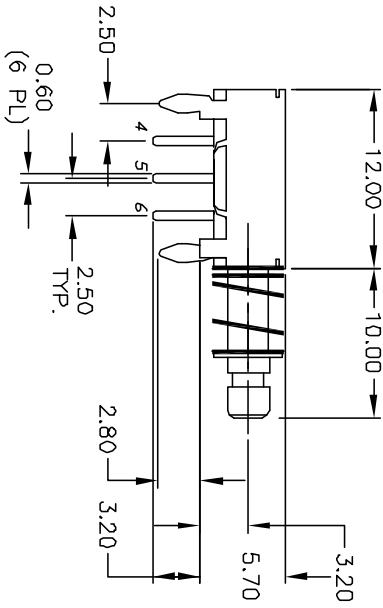

ACTUATOR DETAIL  
SCALE 3X

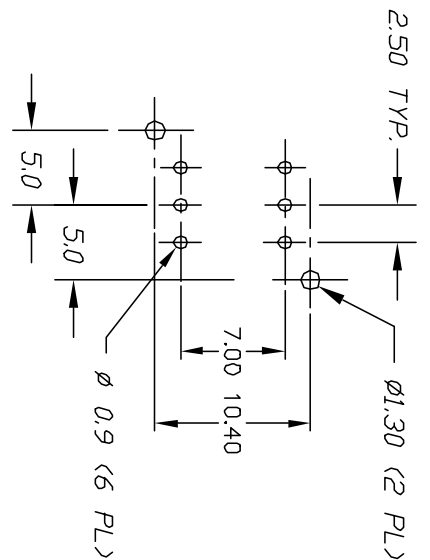
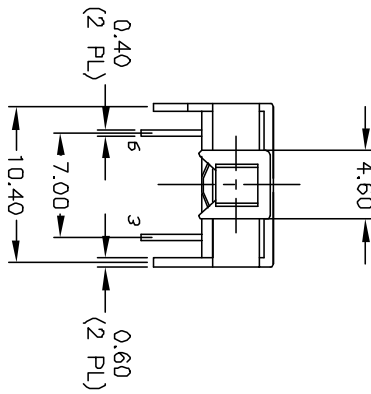

RECOMMENDED P.C.B. HOLES

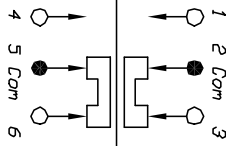

CIRCUIT: DPDT

CONTACT CONFIGURATION

NOTES:

1. ALL DIMENSIONS IN MM
2. GENERAL TOLERANCE: X.X=±0.4  
X.XX=±0.25
3. TERM. NOS. FOR REFERENCE ONLY.
4. RATING: DC 30V, 0.3A
5. TIMING: NON SHORTING (BBM)
6. TRAVEL: FULL: 3.5mm  
LOCK: 2.5mm
7. OPERATING FORCE: 300±100gf

**E-SWITCH®**

REV.	ECN No.	DESCRIPTION	DATE	CHKD
A	11552	RELEASED FOR PRODUCTION	6/28/01	CJB
THE INFORMATION CONTAINED IN THIS DOCUMENT IS PROPRIETARY TO E-SWITCH AND IS NOT TO BE COPIED OR TRANSFERRED				

TITLE	SCALE	DATE	DR	DWG	REV
LC2251 DA NP (MOMENTARY)	2:1	6/28/01	CJB	P070145	A