

Excellent Integrated System Limited

Stocking Distributor

Click to view price, real time Inventory, Delivery & Lifecycle Information:

[E-Switch](#)
[R1966ABLKBLKGL](#)

For any questions, you can email us directly:

sales@integrated-circuit.com

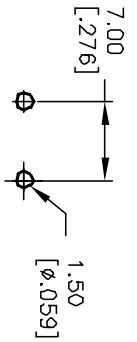
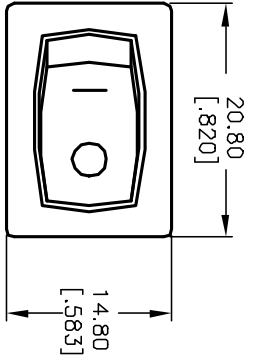

RECOMMENDED P.C.B. LAYOUT

PANEL THICKNESS	X dimension
0.75-1.25 [0.30-0.49]	19.2-21 [0.756]
1.25-2.0 [0.49-0.79]	19.4-21 [0.764]
2.0-3.0 [0.79-1.18]	19.8-21 [0.780]

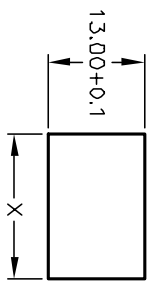

PANEL CUTOUT NOT TO SCALE

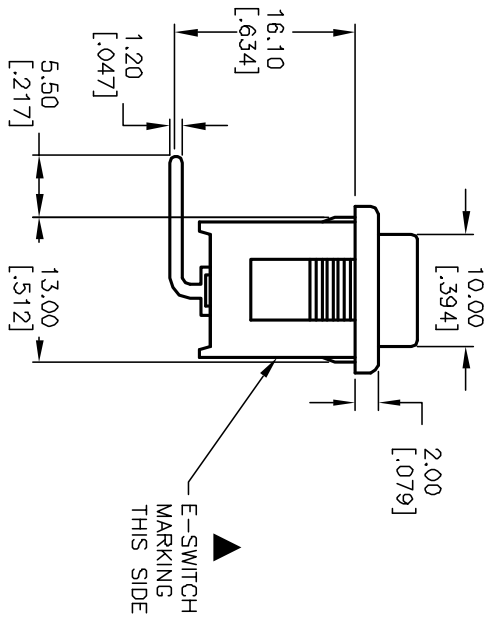
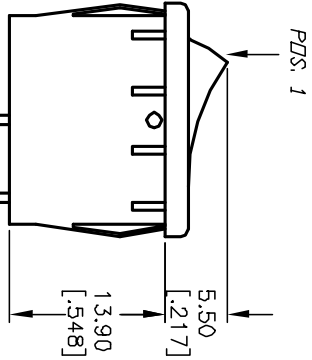

SWITCH FUNCTION	
POS. 1	POS. 2
DN	OFF
1-1a	OPEN

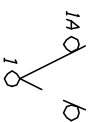

CIRCUIT: SPST

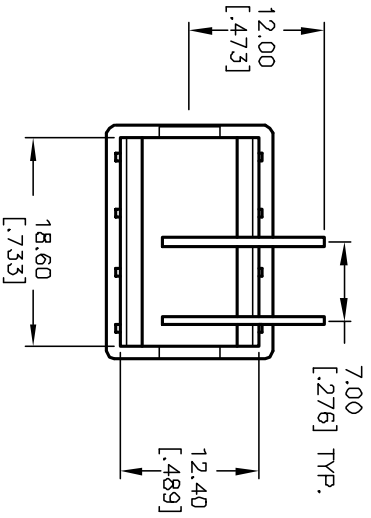

NOTES:

1. ALL DIMENSIONS IN MM [INCH]
2. GENERAL TOLERANCE: X.X=±0.4
X.XX=±0.25
3. TERMINAL NUMBERS FOR REF ONLY
4. RATING: 15A @ 125VAC OR
6A @ 250VAC
5. MATERIALS: TERMINALS: Silver Plated Copper Alloy
CONTACTS: Coin Silver, Silver Plated
6. ELECTRIC LIFE: 10,000 cycles
7. CONTACT RESISTANCE: <20 Mega Ω
8. INSULATION RESISTANCE: >1000 Mega Ω
9. DIELECTRIC STRENGTH: >1500 V 1 minute
>3000 V between poles

E-SWITCH®

B	13007	RELEASED FOR PRODUCTION	4/7/03	AR
REV.	ECN No.	DESCRIPTION	DATE	CHKD

TITLE		DATE		REV
R1966A BLK BLK G L		4/7/03		A
SCALE	DR	DWG	REV	
1.5:1	AR	M301222	A	

THE INFORMATION CONTAINED IN THIS DOCUMENT IS PROPRIETARY TO E-SWITCH AND IS NOT TO BE COPIED OR TRANSMITTED