

Excellent Integrated System Limited

Stocking Distributor

Click to view price, real time Inventory, Delivery & Lifecycle Information:

[Omron](#)
[J-7Y](#)

For any questions, you can email us directly:
sales@integrated-circuit.com

OMRON

Ultra Subminiature Basic Switch

J

Subminiature Models Capable of Large-capacity Loads

- Snap-action switch allows large-capacity switching (7 A at 250 VAC) in spite of its small size (8.9 × 12.7 × 5.1 mm).
- Particularly suitable as control switches for applications where there are restrictions on installation space and weight.
- Easy positioning, as the pin plunger is located in alignment with the center line of one of the two mounting holes.

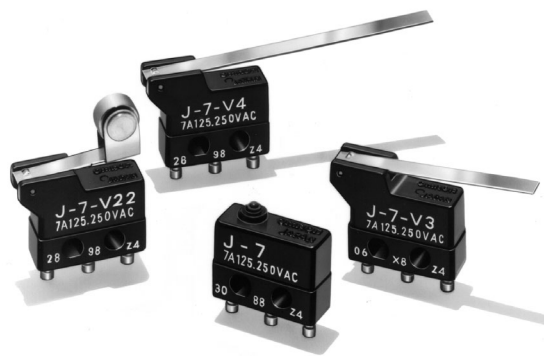

Ordering Information

Model Number Legend

J-7□-□
 1 2 3

1. Ratings

7: 7 A at 250 VAC





2. Contact Material

None: Gold-plated silver
 Y: Silver

3. Actuator

None: Pin plunger
 V: Short hinge lever
 V3: Hinge lever
 V4: Long hinge lever
 V22: Short hinge roller lever
 V2: Hinge roller lever

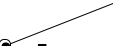
List of Models

Actuator	Model
Pin plunger 	J-7
Short hinge lever 	J-7-V
Hinge lever 	J-7-V3
Long hinge lever 	J-7-V4
Short hinge roller lever 	J-7-V22
Hinge roller lever 	J-7-V2

Note: Externally mounted levers JAL and JAL2 are sold separately. Refer to page 208.

Specifications

■ Ratings

Rated voltage	Resistive load
125 VAC	7 A
250 VAC	7 A

Note: The ratings values apply under the following test conditions:

- Ambient temperature: 20±2°C
- Ambient humidity: 65±5%
- Operating frequency: 30 operations/min

■ Switching Capacity per Load (Reference Values)

Voltage	Non-inductive load				Inductive load			
	Resistive load		Lamp load		Inductive load		Motor load	
	NC	NO	NC	NO	NC	NO	NC	NO
125 VAC	7 A		1.5 A	0.7 A	4 A		2.5 A	1.3 A
250 VAC	7 A		1.5 A	0.7 A	4 A		2.5 A	1.3 A
8 VDC	7 A		1.5 A	0.7 A	3 A		2.5 A	1.3 A
14 VDC	7 A		1.5 A	0.7 A	3 A		2.5 A	1.3 A
30 VDC	5 A		1.5 A	0.7 A	3 A		2.5 A	1.3 A
125 VDC	0.4 A		0.4 A	0.4 A	0.03 A		0.03 A	0.03 A
250 VDC	0.2 A		0.2 A	0.2 A	0.02 A		0.02 A	0.02 A

- Note:**
- The above values are for the steady-state current.
 - Inductive load has a power factor of 0.4 min. (AC) and a time constant of 7 ms max. (DC).
 - Lamp load has an inrush current of 10 times the steady-state current.
 - Motor load has an inrush current of 6 times the steady-state current.

■ Characteristics

Operating speed	0.05 mm to 1 m/s (pin plunger models)
Operating frequency	Mechanical: 400 operations/min max. Electrical: 30 operations/min max.
Insulation resistance	100 MΩ min. (at 500 VDC)
Contact resistance (initial value)	15 mΩ max.
Dielectric strength	600 VAC, 50/60 Hz for 1 min between terminals of the same polarity 1,500 VAC, 50/60 Hz for 1 min between each terminal and non-current-carrying metal part and between current-carrying metal part and ground.
Vibration resistance (see note 2)	Malfunction: 10 to 55 Hz, 1.5-mm double amplitude
Shock resistance (see note 2, 3)	Destruction: 1,000 m/s ² {approx. 100G} max. Malfunction: 200 m/s ² {approx. 20G} max. (pin plunger models)
Durability (see note 4)	Mechanical: 10,000,000 operations min. (60 operations/min) Electrical: 50,000 operations min. (30 operations/min)
Degree of protection	IEC IP40
Degree of protection against electric shock	Class I
Proof tracking index (PTI)	175
Ambient operating temperature	-10°C to 80°C (at ambient humidity of 60% max.) (with no icing)
Ambient operating humidity	85% max. (for 5°C to 35°C)
Weight	Approx. 1 g (pin plunger models)

- Note:**
- The data given above are initial values.
 - Malfunction: 1 ms max.
 - For the pin plunger models, the values are at the free position and total travel position. For the lever models, they are at the total travel position.
 - For testing conditions, consult your OMRON sales representative.

■ **Approved Standards**

Consult your OMRON sales representative for specific models with standard approvals.

**UL508 (File No. E41515)/
 CSA C22.2 No. 55 (File No. LR21642)**

Rated voltage	J-7
125 VAC	7 A
250 VAC	

■ **Contact Specifications**

Contact	Specification	Rivet
	Material	Silver plated Gold plated
	Gap (standard value)	0.35 mm
Inrush current	NC	15 A max.
	NO	7 A max.
Minimum applicable load		30 mA at 5 VDC

■ **Contact Form**

SPDT

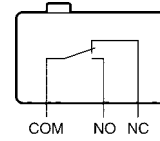

Engineering Data (Reference Values)

Mechanical Durability

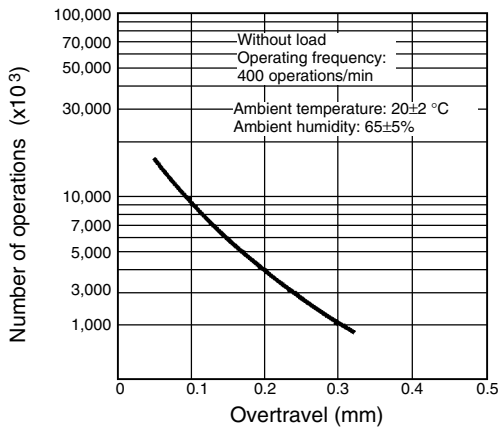

Electrical Durability

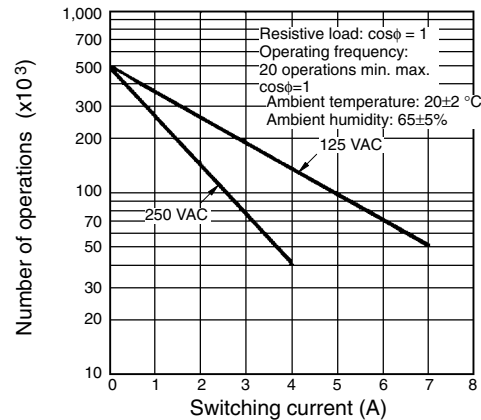

Dimensions

■ Mounting Holes

Note: All units are in millimeters unless otherwise indicated.

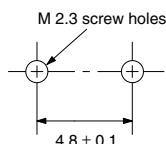

■ Dimensions and Operating Characteristics

- Note:**
1. All units are in millimeters unless otherwise indicated.
 2. Unless otherwise specified, a tolerance of ± 0.2 mm applies to all dimensions.
 3. The operating characteristics are for operation in the A direction (▼).

Pin Plunger Models

J-7

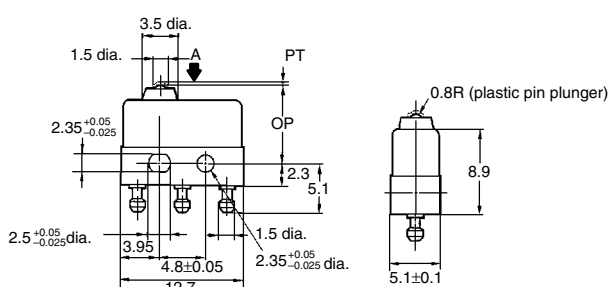
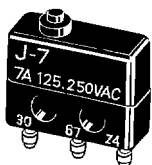

Model	J-7
OF max.	1.37 N {140 gf}
RF min.	0.27 N {28 gf}
PT max.	0.6 mm
OT min.	0.1 mm
MD max.	0.15 mm
OP	8.1 ± 0.3 mm

Short Hinge Lever Models

J-7-V

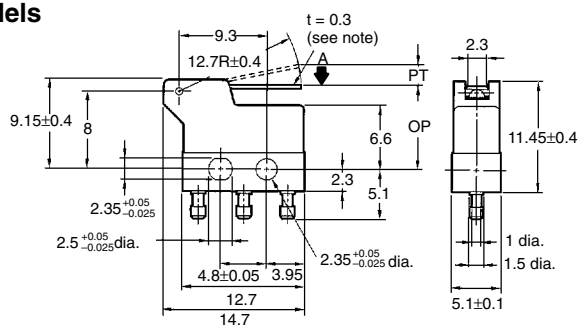
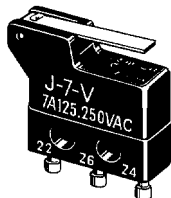

Model	J-7-V
OF max.	0.49 N {50 gf}
RF min.	0.08 N {9 gf}
PT max.	1.7 mm
OT min.	0.35 mm
MD max.	0.5 mm
OP	8.3 ± 1.2 mm

Note: Stainless-steel spring lever

Hinge Lever Models

J-7-V3

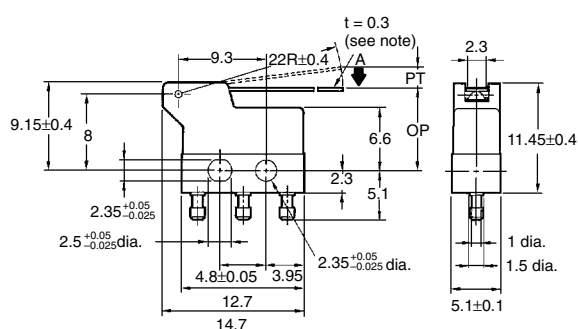
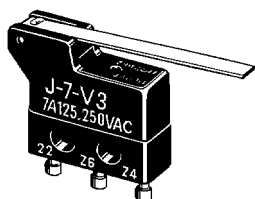

Model	J-7-V3
OF max.	0.29 N {30 gf}
RF min.	0.04 N {5 gf}
PT max.	2.9 mm
OT min.	0.5 mm
MD max.	0.7 mm
OP	8.3 ± 1.9 mm

Note: Stainless-steel spring lever

Long Hinge Lever Models
J-7-V4

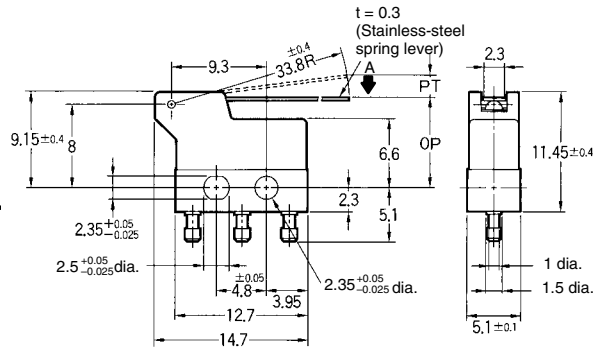
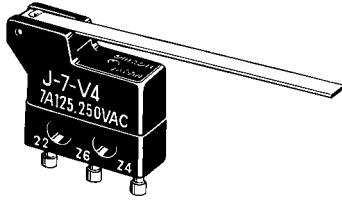

Model	J-7-V4
OF max.	0.20 N {20 gf}
RF min.	0.02 N {3 gf}
PT max.	4.5 mm
OT min.	0.8 mm
MD max.	1.2 mm
OP	8.3±2.9 mm

Short Hinge Roller Lever Models
J-7-V22

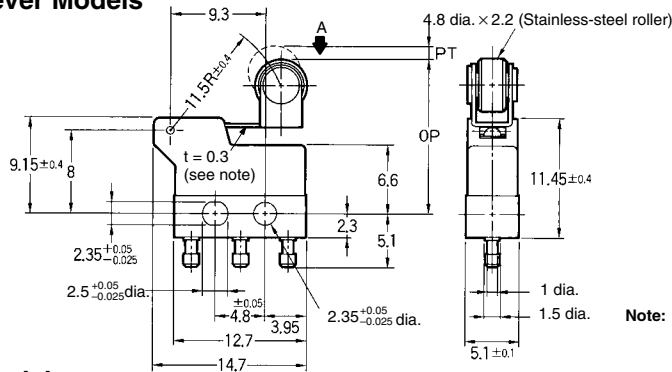
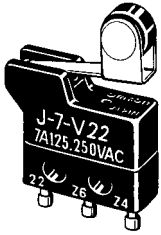

Model	J-7-V22
OF max.	0.54 N {55 gf}
RF min.	0.04 N {5 gf}
PT max.	1.6 mm
OT min.	0.25 mm
MD max.	0.4 mm
OP	14.7±1 mm

Note: Stainless-steel spring lever

Hinge Roller Lever Models
J-7-V2

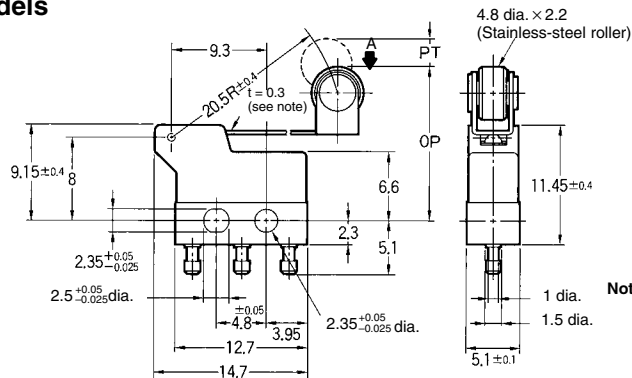
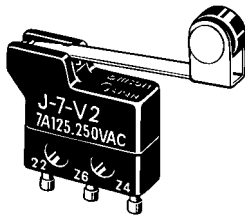

Model	J-7-V2
OF max.	0.324 N {33 gf}
RF min.	0.02 N {3 gf}
PT max.	2.7 mm
OT min.	0.45 mm
MD max.	0.7 mm
OP	14.7±1.9 mm

Note: Stainless-steel spring lever

Accessories (Sold Separately)

Actuators

Leaf Spring

JAL

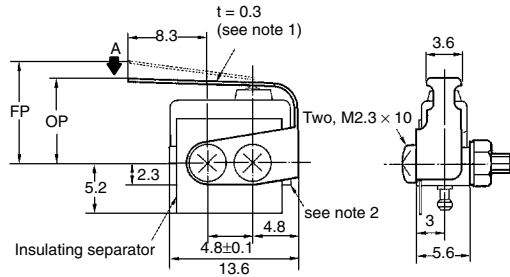
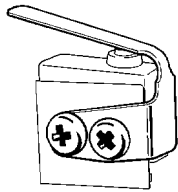

Model	JAL
OF max.	1.95 N {199 gf}
RF min.	0.54 N {56 gf}
PT max.	5.2 mm (reference value)
OT min.	0.3 mm
MD max.	0.8 mm
FP max.	13.1 mm
OP	8.7±0.8 mm

Note: 1. Stainless-steel spring lever
 2. J-7 Subminiature Basic Switch

JAL2

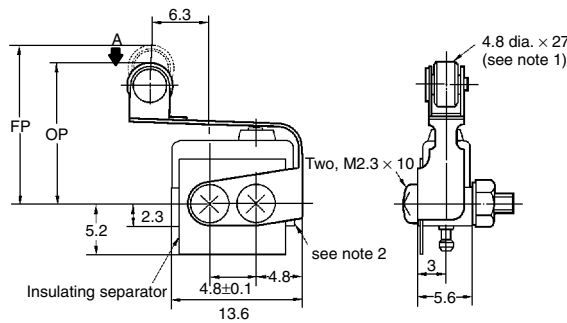
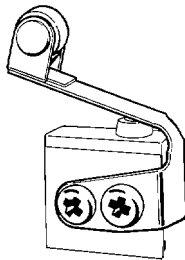

Model	JAL2
OF max.	1.95 N {199 gf}
RF min.	0.54 N {56 gf}
PT max.	3.6 mm (reference value)
OT min.	0.3 mm
MD max.	0.8 mm
FP max.	19.5 mm
OP	15.1±0.8 mm

Note: 1. Stainless-steel spring lever
 2. J-7 Subminiature Basic Switch

Precautions

Refer to pages 26 to 31 for common precautions.

■ **Correct Use**

Mounting

Use two M2.3 screws with plain washers or spring washers to securely mount the Switch. Tighten the screws to a torque of 0.19 to 0.29 N • m {2 to 3 kgf • cm}.

Soldering

To solder the lead to the terminal, apply a soldering iron rated at 30 W max. quickly (within 3 seconds) with the actuator at the free position.

Applying a soldering iron for too long a time or using one that is rated at more than 30 W may degrade the Switch characteristics.

ALL DIMENSIONS SHOWN ARE IN MILLIMETERS.
 To convert millimeters into inches, multiply by 0.03937. To convert grams into ounces, multiply by 0.03527.