



Distributor of Hammond Manufacturing: Excellent Integrated System Limited

Datasheet of 519-0910 - CONSOLE STEEL GRAY 5.91"LX8.68"W

Contact us: sales@integrated-circuit.com Website: www.integrated-circuit.com

Excellent Integrated System Limited

Stocking Distributor

Click to view price, real time Inventory, Delivery & Lifecycle Information:

[Hammond Manufacturing](#)
[519-0910](#)

For any questions, you can email us directly:

sales@integrated-circuit.com

**DETAIL A
SCALE 1 / 2
END VENTS**

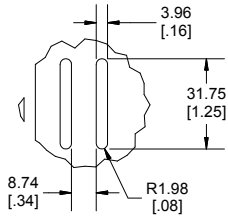

TOP VIEW OF ENCLOSURE

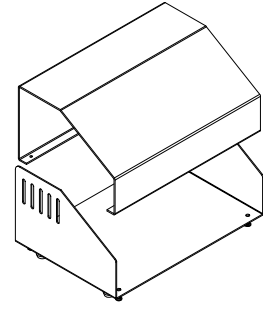
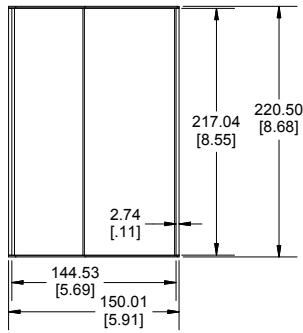

BACK VIEW OF ENCLOSURE

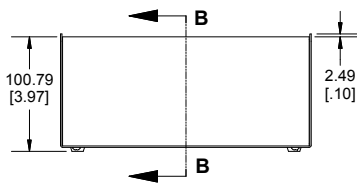

END VIEW OF ENCLOSURE

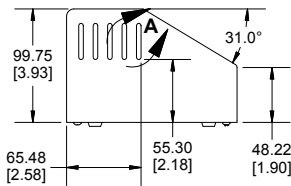

FRONT VIEW OF ENCLOSURE

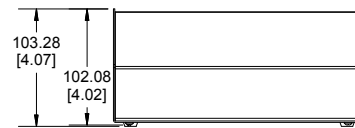

Enclosures can be Factory Modified (Milling, Drilling, Printing etc.)
Contact Factory mjm@hammondmfg.com for quotes
Solid models of this enclosure available in STEP or IGES.

NOTE

Case Includes Adhesive Rubber Feet and Required Hardware.
Enclosure Case is Made of 0.05" Steel.
Top Panel is Made of 0.064" Aluminum.

PART NUMBERS

519-0910 Enclosure

Smooth Light Grey Top Case
Dark Satin Grey Base Case

519-0910

ACCESSORIES

Plated Cover Screws (Pkg 50)
[#6 x 1/4 Self Tapping]

SC19482-50

Grey Self-Adhesive Rubber Feet (Pkg 4)

1421T2GY

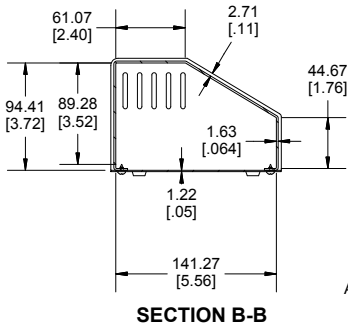

SECTION B-B

BOTTOM VIEW OF ENCLOSURE

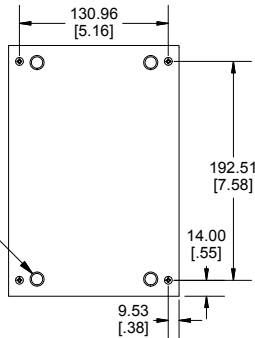

ADHESIVE RUBBER FEET

Dimensions:
mm
[inches]



**HAMMOND
MANUFACTURING™**

519-9010

www.hammondmfg.com