

## Excellent Integrated System Limited

Stocking Distributor

Click to view price, real time Inventory, Delivery & Lifecycle Information:

[Samtec, Inc.](#)  
[FTSH-105-01-F-D-K](#)

For any questions, you can email us directly:  
[sales@integrated-circuit.com](mailto:sales@integrated-circuit.com)

REVISION BR

NOTES:

1.  $\text{C}$  REPRESENTS A CRITICAL DIMENSION.
2. PARTS MAY BE CUT TO POSITION.
3. MAXIMUM CUT FLASH: .010[0.25] ON TAIL SIDE. ALL OTHER AREAS AT .015[0.38]. LOOSE CUT FLASH MUST BE REMOVED.
4. MINIMUM PUSHOUT FORCE: 1.0 LB.
5. TERMINALS TO BE SHEARED TO MEET DIMENSION SPECIFICATION.
6. LAYER PACKAGE 2 - 4 POSITIONS AND TUBE 5 - 50 POSITIONS.
7. MAXIMUM BURR ALLOWANCE: .003[0.08].
8. DUE TO THE HIGH AMOUNT OF INSERTION FORCE NEEDED, THE -EC OPTION IS NOT COMPATIBLE WITH AUTO PLACEMENT. SAMTEC RECOMMENDS MANUAL PLACEMENT FOR ALL ASSEMBLIES WITH THE -EC OPTION.
9. MAXIMUM HEIGHT VARIATION BETWEEN ROWS: .005[0.13].

DO NOT SCALE FROM THIS PRINT

FTSH-1XX-XX-XXX-D-XX

NO OF POSITIONS  
-02 THRU -50  
(PER ROW)

LEAD STYLE  
-01: .120 [3.05]  
-02: .075 [1.91]  
-03: .065 [1.65]  
-04: .150 [3.81]

OPTIONS

- ES: END SHROUDS (SEE FIG 2, SHT 2) (MOLDED 5 POS MIN; -02 & -03 LEAD STYLE ONLY) (MUST USE FTSH-XX-ES-XX)
- EJ: EJECTOR SHROUDS: (SEE FIG 3, SHT 2) (10 POS MIN; -01 LEAD STYLE ONLY) (MUST USE FTSH-50-D)
- EC: LOCKING CLIP (SEE FIG 4, SHT 2; SEE NOTE 8) (9 POS MIN; -02 & -03 LEAD STYLES ONLY) (MUST USE FTSH-50-D)
- EP: GUIDE POST (SEE FIG 5, SHT 2) (9 POS MIN; -02 & -03 LEAD STYLES ONLY) (USE ONLY WHEN MATING WITH CLP) (MUST USE FTSH-50-D)
- EL: BOARD LOCKS (SEE FIG 6, SHT 2) (9 POS MIN; -02 & -03 LEAD STYLES ONLY) (USE ONLY WHEN MATING WITH CLP) (MUST USE FTSH-50-D)
- K: KEYING OPTION FOR MATING WITH FFSD (05 THRU 25 ONLY) (POSITION 13, 17, 20 & 25 AVAILABLE WITH -EJ OPTION) (LEAD STYLE -01 ONLY, SEE FIG 7, SHT 3) (MUST USE FTSH-XX-CN-XX)
- LC: LOCKING CLIP: (SEE FIG 8, SHT 3) (5 POS MIN, ONLY AVAILABLE IN -01 LEAD STYLE) (IN COMBINATION WITH -K, USE FTSH-XX-CN-XX, 10 POSITION MINIMUM, ONLY AVAILABLE IN -01 LEAD STYLE) (MUST USE FTSH-50-D) (SINGLE MATING CYCLE ONLY) (MUST BE MATED TO SAMTEC FFSD SERIES)

PLATING SPECIFICATION

- G: 10 $\mu$ " GOLD IN CONTACT AREA, 3 $\mu$ " GOLD ON TAIL
- F: 3 $\mu$ " FLASH SELECTIVE GOLD IN CONTACT AREA, MATTE TIN ON TAIL
- L: 10 $\mu$ " LIGHT SELECTIVE GOLD IN CONTACT AREA, MATTE TIN ON TAIL
- S: 30 $\mu$ " SELECTIVE GOLD IN CONTACT AREA, MATTE TIN ON TAIL
- H: 30 $\mu$ " HEAVY GOLD IN CONTACT AREA, 3 $\mu$ " GOLD ON TAIL
- FM: 3 $\mu$ " FLASH SELECTIVE GOLD IN CONTACT AREA, MATTE TIN ON TAIL
- LM: 10 $\mu$ " LIGHT SELECTIVE GOLD IN CONTACT AREA, MATTE TIN ON TAIL
- SM: 30 $\mu$ " HEAVY SELECTIVE GOLD IN CONTACT AREA, MATTE TIN ON TAIL
- LT: 10 $\mu$ " LIGHT GOLD IN CONTACT AREA, TIN/LEAD (90%/10 +/-5%) ON TAIL

ROW SPECIFICATION

- D: DOUBLE ROW
- (USE \*\*FTSHC-1XX-XX-XXX-D UNLESS OPTION IS SPECIFIED ABOVE. WHEN OPTION IS SPECIFIED, BUILD PER PRINT USING BODY SPECIFIED FOR REQUIRED OPTION)
- \*\* = SEE FTSHC-1XX-XX-XXX-DX-XX PRINT FOR DETAILS

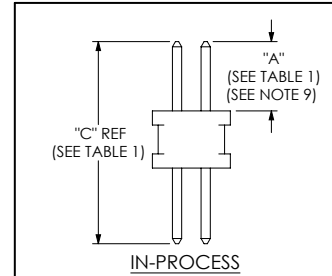
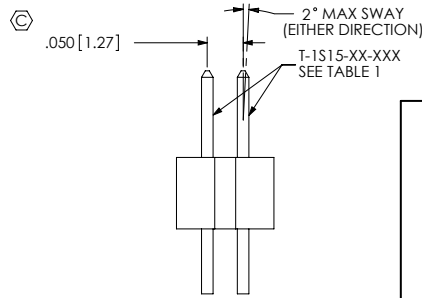
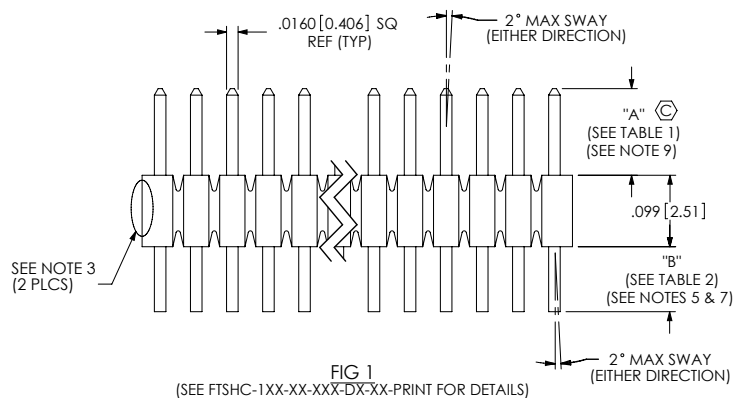
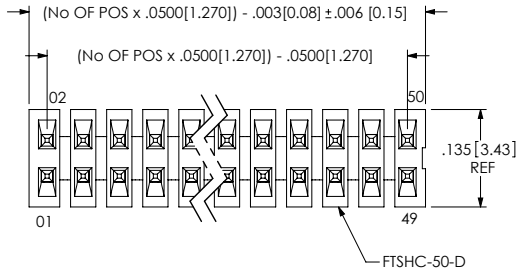

LEAD STYLE	"A"	TERMINAL	"C" REF
-01	.120 [3.05]	T-1S15-02-XX	.350 [8.89]
-02	.075 [1.91]	T-1S15-02-XX	.350 [8.89]
-03	.065 [1.65]	T-1S15-04-XX	.450 [11.43]
-04	.150 [3.81]	T-1S15-04-XX	.450 [11.43]

OPTIONS	"B"
NONE	.09 [2.3]
-ES, -EC	.09 [2.3]
-EJ, -EJ-K	.11 [2.7]
-EP	.09 [2.3]
-EL	.09 [2.3]
-K	.09 [2.3]
-LC, -K-LC	.12 [3.0]

UNLESS OTHERWISE SPECIFIED, DIMENSIONS ARE IN INCHES. TOLERANCES ARE:  
DECIMALS: .XX: ±.01 [.3] 1"  
.XXX: ±.005 [.13]  
.XXXX: ±.0010 [.025]

PROPRIETARY NOTE  
THIS DOCUMENT CONTAINS INFORMATION CONFIDENTIAL AND PROPRIETARY TO SAMTEC, INC. AND SHALL NOT BE REPRODUCED OR TRANSFERRED TO OTHER DOCUMENTS OR DISCLOSED TO OTHERS OR USED FOR ANY PURPOSE OTHER THAN THAT WHICH IT WAS OBTAINED WITHOUT THE EXPRESSED WRITTEN CONSENT OF SAMTEC, INC.

MATERIAL: DO NOT SCALE DRAWING SHEET SCALE: 5:1  
INSULATOR: LCD UL 94-V0  
TERMINAL: PHOSPHOR BRONZE

DESCRIPTION:  
.050 x .050 CL THROUGH HOLE TERMINAL STRIP

DWG. NO. FTSH-1XX-XX-XXX-D-XX

BY: J. FERRY 02/27/1996 SHEET 1 OF 3

520 PARK EAST BLVD, NEW ALBANY, IN 47150  
PHONE: 812-944-6733 FAX: 812-948-5047  
e-Mail: info@SAMTEC.com code 55322

REVISION BR

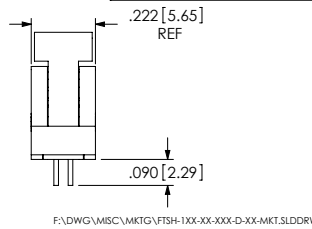
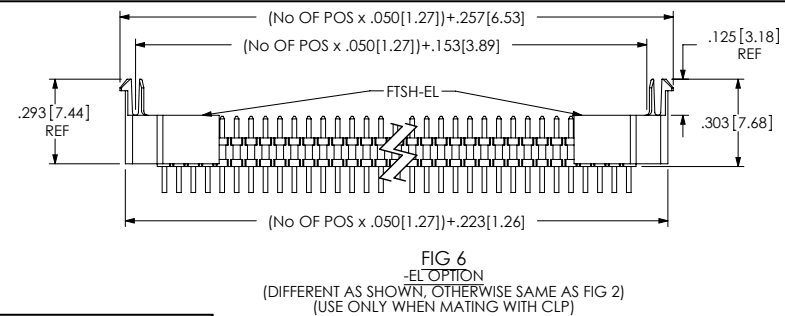
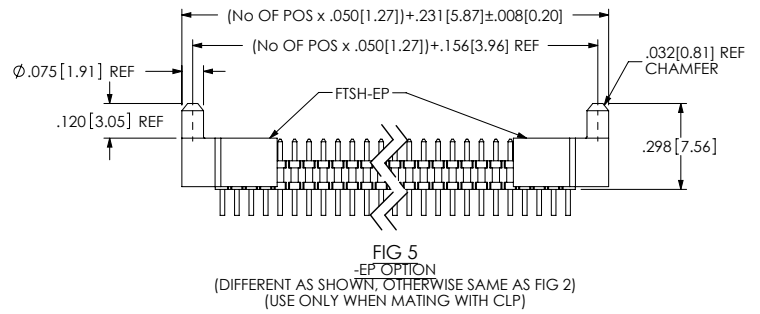
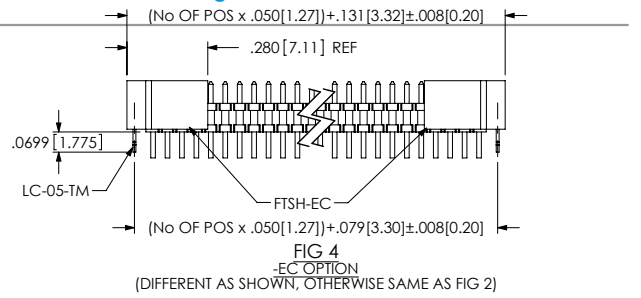
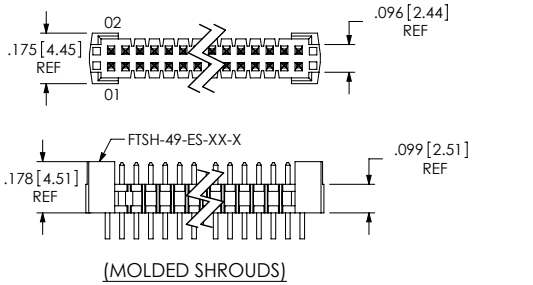
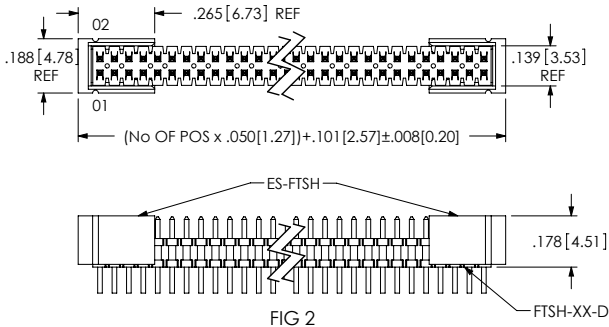

**PROPRIETARY NOTE**  
THIS DOCUMENT CONTAINS INFORMATION CONFIDENTIAL AND PROPRIETARY TO SAMTEC, INC. AND SHALL NOT BE REPRODUCED OR TRANSMITTED IN ANY FORM OR BY ANY MEANS, ELECTRONIC OR MECHANICAL, INCLUDING PHOTOCOPYING, RECORDING, OR BY ANY INFORMATION STORAGE AND RETRIEVAL SYSTEM, WITHOUT THE EXPRESS WRITTEN CONSENT OF SAMTEC, INC.

DO NOT SCALE DRAWING

SHEET SCALE: 2:1

<b>samtec</b>	
520 PARK EAST BLVD, NEW ALBANY, IN 47150 PHONE: 812-944-6733 FAX: 812-948-5047 e-Mail: info@SAMTEC.com code 55322	
DESCRIPTION: .050 x .050 CL THROUGH HOLE TERMINAL STRIP	
DWG. NO. <b>FTSH-1XX-XX-XXX-D-XX</b>	
BY: J. FERRY	02/27/1996
SHEET 2 OF 3	

REVISION BR

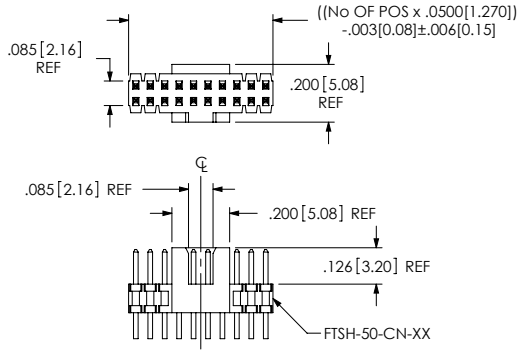

**FIG 7**  
-K OPTION  
(LEAD STYLE -01)  
(DIFFERENT AS SHOWN, OTHERWISE SAME AS FIG 1)  
(POSITION 13, 17, 20 & 25 AVAILABLE WITH -K & -EJ OPTION)

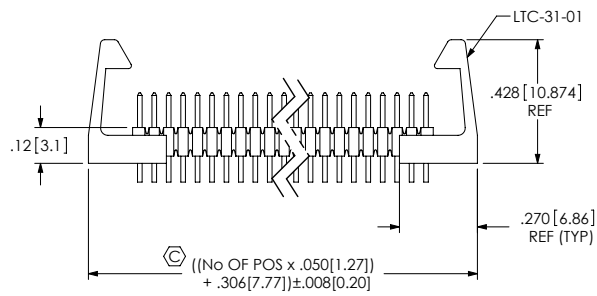

**FIG 8**  
-LC OPTION  
(LEAD STYLE -01)  
(DIFFERENT AS SHOWN, OTHERWISE SAME AS FIG 1)

**TABLE 3**  
(SEE NOTE 6)

LEAD STYLE	OPTION(S)	PACKAGING TUBE	TUBE PLUG
-01, -02, -03	NONE	PT-1-24-01-43	TP-24
-04	NONE	PT-1-24-11-09	TP-09
ALL	-EJ, -EJ-K, -LC, -K-LC	PT-1-24-05-09	TP-07
ALL	-EC, -EC-K	PT-1-24-01-38	TP-24
ALL	-EL, -EP, -EL-K, -EP-K	PT-1-24-03-09	TP-09
ALL	-K	PT-1-24-11-09	TP-09
ALL	-ES, -ES-K	PT-1-24-01-55	TP-24

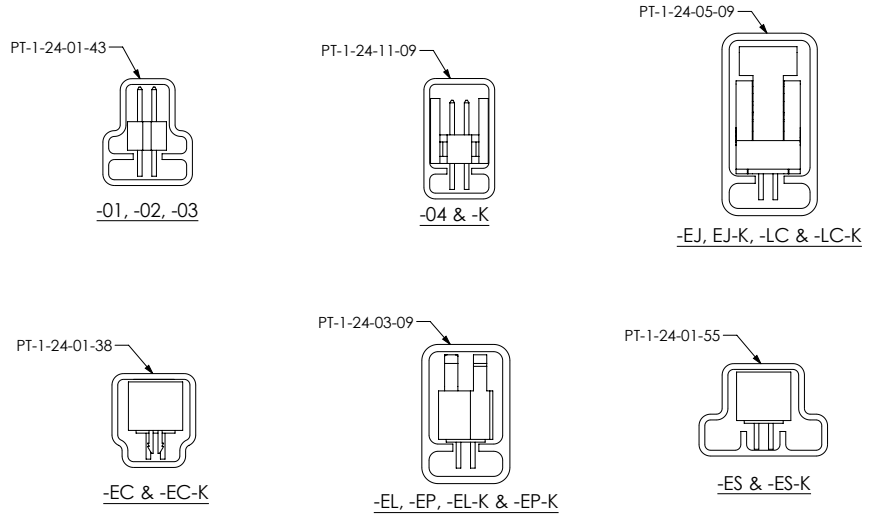

**FIG 9**  
TUBE VIEWS

F:\DWG\MISC\MKTG\FTSH-1XX-XX-XXX-D-XX-MKT.SLDDRW

**PROPRIETARY NOTE**  
 THIS DOCUMENT CONTAINS INFORMATION CONFIDENTIAL AND PROPRIETARY TO SAMTEC, INC. AND SHALL NOT BE REPRODUCED OR TRANSFERRED TO OTHER DOCUMENTS OR DISCLOSED TO OTHERS OR USED FOR ANY PURPOSE OTHER THAN THAT WHICH IT WAS OBTAINED WITHOUT THE EXPRESSED WRITTEN CONSENT OF SAMTEC, INC.  
 DO NOT SCALE DRAWING  
 SHEET SCALE: 2:1

**samtec**  
 520 PARK EAST BLVD, NEW ALBANY, IN 47150  
 PHONE: 812-944-6733 FAX: 812-948-5047  
 e-Mail info@SAMTEC.com code 55322

DESCRIPTION:  
 .050 x .050 CL THROUGH HOLE TERMINAL STRIP

DWG. NO.  
**FTSH-1XX-XX-XXX-D-XX**

BY: J. FERRY 02/27/1996 SHEET 3 OF 3