

Excellent Integrated System Limited

Stocking Distributor

Click to view price, real time Inventory, Delivery & Lifecycle Information:

[Fairchild Semiconductor](#)

[QSD722](#)

For any questions, you can email us directly:

sales@integrated-circuit.com

PACKAGE DIMENSIONS

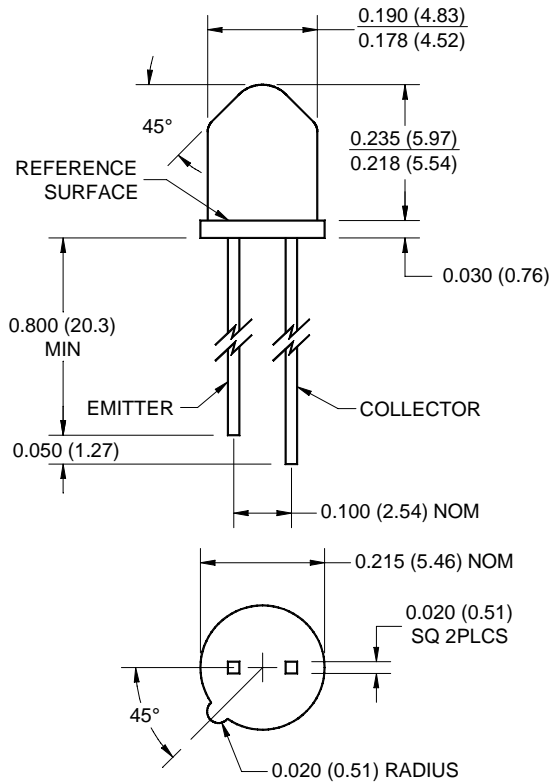

NOTES:

1. Dimensions for all drawings are in inches (mm).
2. Tolerance of $\pm .010$ (.25) on all non-nominal dimensions unless otherwise specified.

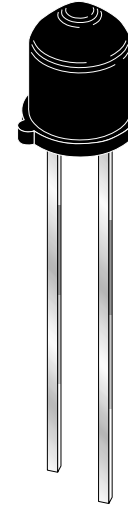

SCHEMATIC

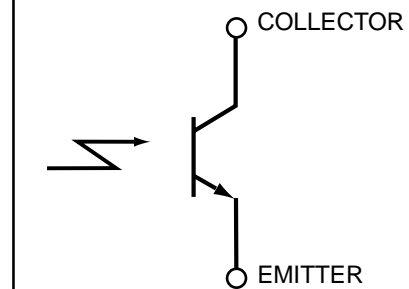

DESCRIPTION

The QSD722/723/724 is a silicon phototransistor encapsulated in an infrared transparent, black TO-18 package.

FEATURES

- NPN Silicon Phototransistor
- Package Type: Plastic TO-18
- Matched Emitter: QED523
- Narrow Reception Angle, 40°
- Daylight Filter
- Package material and color: black epoxy
- High Sensitivity



PLASTIC SILICON INFRARED PHOTOTRANSISTOR

QSD722 QSD723 QSD724

ABSOLUTE MAXIMUM RATINGS (T_A = 25°C unless otherwise specified)

Parameter	Symbol	Rating	Unit
Operating Temperature	T _{OPR}	-40 to +100	°C
Storage Temperature	T _{STG}	-40 to +100	°C
Soldering Temperature (Iron) ^(2,3,4)	T _{SOL-I}	240 for 5 sec	°C
Soldering Temperature (Flow) ^(2,3)	T _{SOL-F}	260 for 10 sec	°C
Collector-Emitter Voltage	V _{CE}	30	V
Emitter-Collector Voltage	V _{EC}	5	V
Power Dissipation ⁽¹⁾	P _D	100	mW

1. Derate power dissipation linearly 1.33 mW/°C above 25°C.
2. RMA flux is recommended.
3. Methanol or isopropyl alcohols are recommended as cleaning agents.
4. Soldering iron 1/16" (1.6mm) minimum from housing.
5. λ = 880 nm, AlGaAs.

ELECTRICAL / OPTICAL CHARACTERISTICS (T_A = 25°C)

PARAMETER	TEST CONDITIONS	SYMBOL	MIN	TYP	MAX	UNITS
Peak Sensitivity Wavelength		λ _{PS}	—	880	—	nm
Reception Angle		θ	—	±20	—	Deg.
Collector-Emitter Dark Current	V _{CE} = 10 V, E _e = 0	I _{CEO}	—	—	100	nA
Collector-Emitter Breakdown	I _C = 1 mA	BV _{CEO}	30	—	—	V
Emitter-Collector Breakdown	I _E = 100 μA	BV _{ECO}	5	—	—	V
On-State Collector Current ⁽⁵⁾						
QSD722			0.6	—	3.8	mA
QSD723	E _e = 0.5 mW/cm ² , V _{CE} = 5 V	I _{C(ON)}	2.5	—	10.0	
QSD724			3.5	—	—	
Saturation Voltage ⁽⁵⁾	E _e = 0.5 mW/cm ² , I _C = 0.6 mA	V _{CE(sat)}	—	0.4	—	V
Rise Time	V _{CC} = 5 V, R _L = 100 Ω, I _C = 0.2 mA	t _r	—	8	—	μs
Fall Time		t _f	—	8	—	

Figure 1. Light Current vs. Radiant Intensity

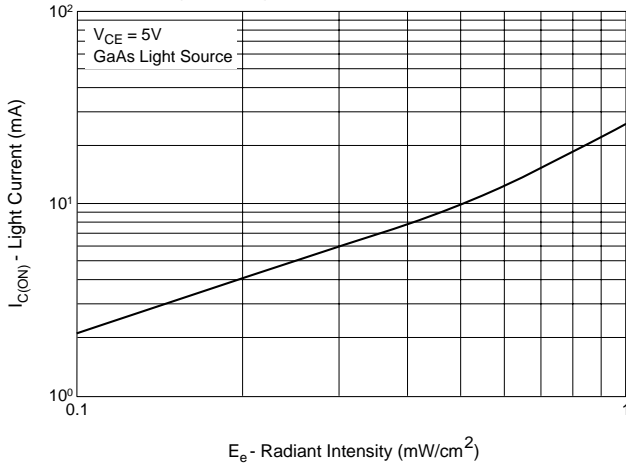

Figure 2. Angular Response Curve

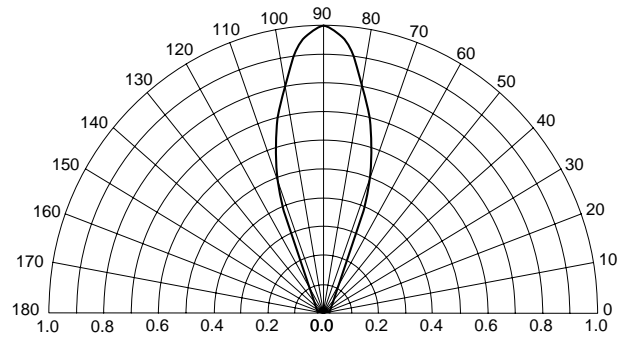

Figure 3. Dark Current vs. Collector - Emitter Voltage

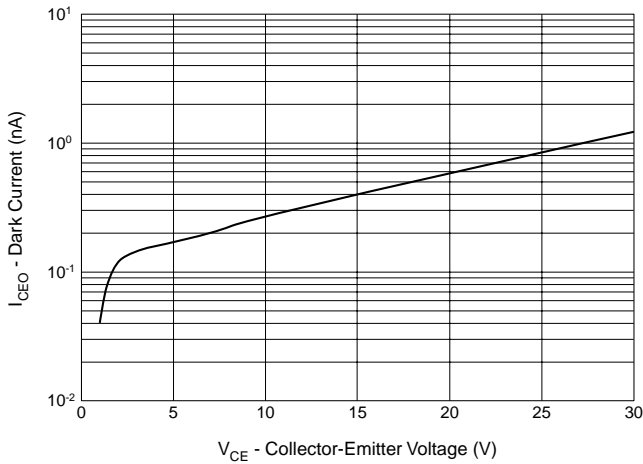

Figure 4. Light Current vs. Collector - Emitter Voltage

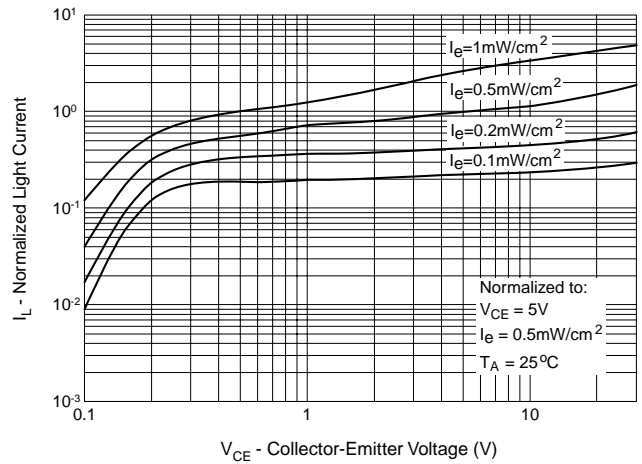
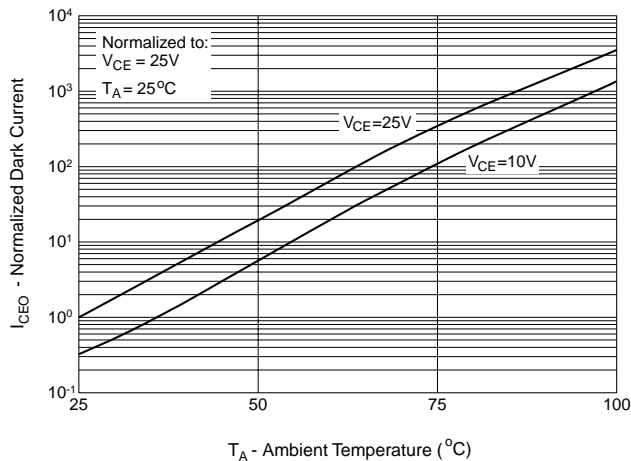

Figure 5. Dark Current vs. Ambient Temperature





PLASTIC SILICON INFRARED PHOTOTRANSISTOR

QSD722 QSD723 QSD724

DISCLAIMER

FAIRCHILD SEMICONDUCTOR RESERVES THE RIGHT TO MAKE CHANGES WITHOUT FURTHER NOTICE TO ANY PRODUCTS HEREIN TO IMPROVE RELIABILITY, FUNCTION OR DESIGN. FAIRCHILD DOES NOT ASSUME ANY LIABILITY ARISING OUT OF THE APPLICATION OR USE OF ANY PRODUCT OR CIRCUIT DESCRIBED HEREIN; NEITHER DOES IT CONVEY ANY LICENSE UNDER ITS PATENT RIGHTS, NOR THE RIGHTS OF OTHERS.

LIFE SUPPORT POLICY

FAIRCHILD'S PRODUCTS ARE NOT AUTHORIZED FOR USE AS CRITICAL COMPONENTS IN LIFE SUPPORT DEVICES OR SYSTEMS WITHOUT THE EXPRESS WRITTEN APPROVAL OF THE PRESIDENT OF FAIRCHILD SEMICONDUCTOR CORPORATION. As used herein:

1. Life support devices or systems are devices or systems which, (a) are intended for surgical implant into the body, or (b) support or sustain life, and (c) whose failure to perform when properly used in accordance with instructions for use provided in labeling, can be reasonably expected to result in a significant injury of the user.
2. A critical component in any component of a life support device or system whose failure to perform can be reasonably expected to cause the failure of the life support device or system, or to affect its safety or effectiveness.