

## **Excellent Integrated System Limited**

Stocking Distributor

Click to view price, real time Inventory, Delivery & Lifecycle Information:

[TE Connectivity AMP Connectors](#)  
[1775427-2](#)

For any questions, you can email us directly:

[sales@integrated-circuit.com](mailto:sales@integrated-circuit.com)

4

3

2

1

THIS DRAWING IS UNPUBLISHED.  
 RELEASED FOR PUBLICATION  
 COPYRIGHT © BY TYCO ELECTRONICS CORPORATION. ALL RIGHTS RESERVED.

REV	DATE	DESCRIPTION	BY	CHKD	APPD
A	22NOV08	FIRST RELEASED	HH	WK	

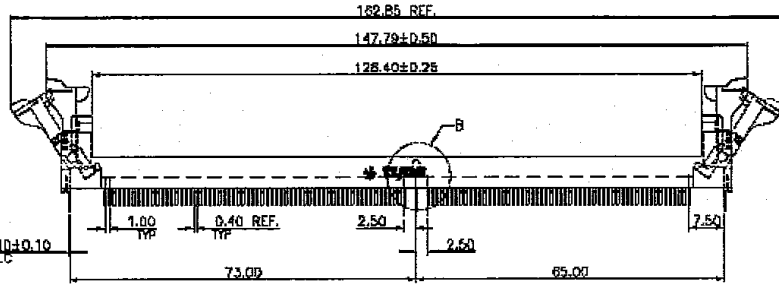
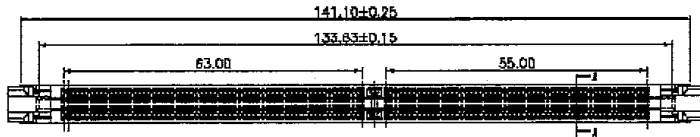

- NOTES:  
 1. MATERIAL:  
 1.1 HOUSING: THERMOPLASTIC (PA66), UL94V-0;  
 COLOR: SEE TABLE.  
 1.2 EXTRACTOR: THERMOPLASTIC (PC), UL94V-0;  
 COLOR: TRANSPARENT.  
 1.3 CONTACTS: BRASS  
 1.4 BOARD LOCK: BRASS  
 2. FINISH:  
 2.1 CONTACT:  
 GOLD PLATING ON CONTACT AREA,  
 2.64µm (100µ" MIN. MATTE TIN PLATING ON SOLDER TAIL AREA,  
 1.27µm (50µ" MIN. NICKEL PLATING OVERALL.  
 2.2 BOARD LOCK:  
 1.27µm (50µ" MIN. NICKEL UNDERPLATING OVERALL.  
 LED LOCATION AS APPLICABLE PER CUSTOMER.  
 4. WAVE SOLDER CAPABLE TO 285°C  
 PER TYCO SPEC. 109-202, CONDITION B.

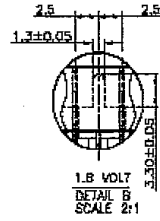
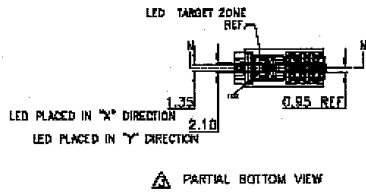
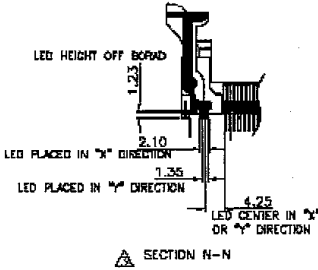
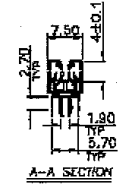
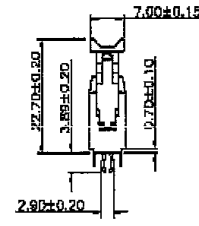

HSG. COLOR	GOLD PLATING	PART NUMBER
WHITE	0.782µm (30u") 0.381µm (15u") GOLD FLASH	1- -3 1- -2 1- -1
BLACK	0.782µm (30u") 0.381µm (15u") GOLD FLASH	-3 -2 1775427-1

THIS DRAWING IS A CONTROLLED DOCUMENT.		DATE: 22NOV2008	Tyco Holdings (Bermuda) Electronics VI Ltd. Taiwan Branch	
DRAWN: H. HUANG		CHKD: S. HOU	NAME: W. J. KE	
DIMENSIONS: MM		PRODUCT SPEC: 10B-57636		DIMM DDRII SOCKET 240P WITH TRANSPARENT LATCH
TOLERANCES UNLESS OTHERWISE SPECIFIED:		QUALIFICATION TEST REPORT: 501-57741		
0 PLC ± 0.25 1 PLC ± 0.30 2 PLC ± 0.15 3 PLC ± 0.15 4 PLC ± 0.15 5 PLC ± 0.15		WEIGHT: 10 GRAMS		SIZE: A3 DATE CODE: 00779 DRAWING NO: C=1775427
MATERIAL: SEE NOTE		FINISH: SEE NOTE		CUSTOMER DRAWING SCALE: — SHEET: 1 OF 3 REV: A

4 3 2 1

THIS DRAWING IS UNPUBLISHED  
 NOTED FOR PUBLICATION  
 COPYRIGHT - BY THE ELECTRONICS CORPORATION. ALL RIGHTS RESERVED.

REV	DATE	DESCRIPTION	BY	APP
1				

REV. SHEET 1.

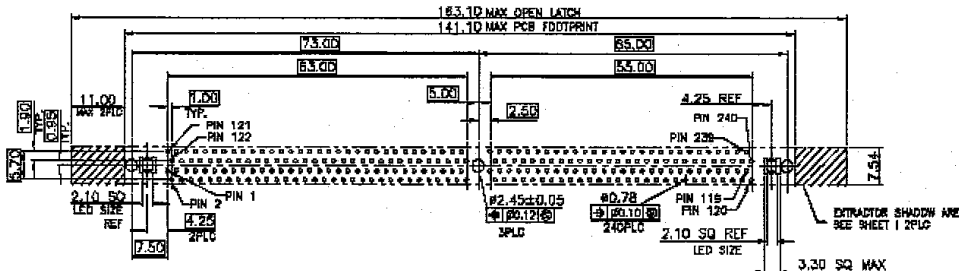

RECOMMENDED PCB LAYOUT  
 PCB TOLERANCE: ±0.05

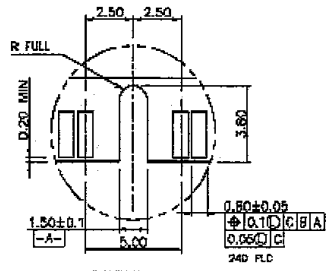

DETAIL A  
 SCALE 4:1

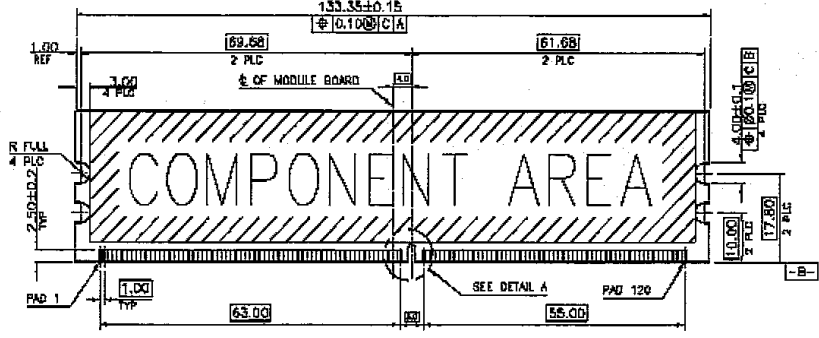

RECOMMENDED MODULE LAYOUT

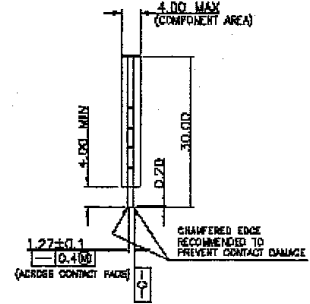

THIS DRAWING IS A CONTROLLED DOCUMENT.		DATE: 22/04/2008	TE Connectivity		TYPE HOLDING (BERMUDA)
DRAWN: H. HUANG		CHK: S. HOU	TE Connectivity		VI Ltd. Taiwan Branch
APPROVED: W. J. KE		PRODUCT SPEC: -	DIMM DDRII SOCKET 240P WITH TRANSPARENT LATCH		RESTRICTED TO
QUALIFICATION TEST REPORT: -		SIZE: A3	QNT CODE: 00779	DRAWING NO: C-1775427	REV: A
MATERIAL: SEE NOTE		CUSTOMER DRAWING		SCALE: -	SHEET: 2 OF 3
TOLERANCE LIMITS (OTHERWISE SPECIFIED): 0 PLC ±0 1 PLC ±0.05 2 PLC ±0.10 3 PLC ±0.15 4 PLC ±0.20					

4

3

2

1

THIS DRAWING IS UNPUBLISHED. ALL RIGHTS RESERVED.  
 © COPYRIGHT - BY TYCO ELECTRONICS COMPANY

REV	DATE	DESCRIPTION	DATE	BY	APPD
DW	-	SEE SHEET 1.			

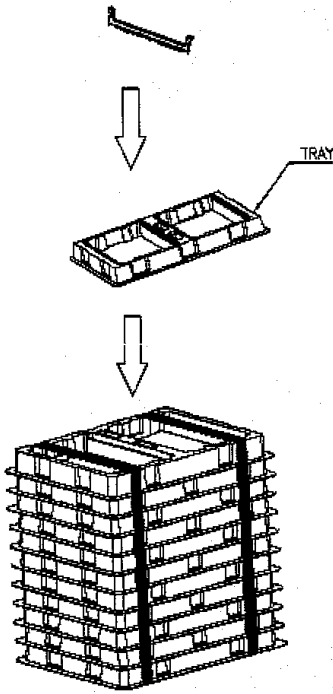

- NOTE:
- DIMENSION:  
 TRAY: L = 385, W = 255, H = 33  
 CARTON: L = 385, W = 270, H = 365
  - QUANTITY:  
 50 PCS/TRAY  
 10 TRAYS/CARTON (500 PCS/CARTON)
  - WEIGHT:  
 NET WEIGHT : 5.0KG  
 GROSS WEIGHT : 7.0KG

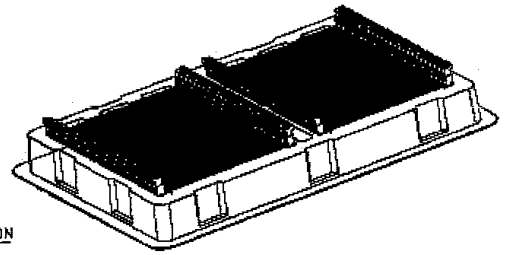

TRAY LAYOUT

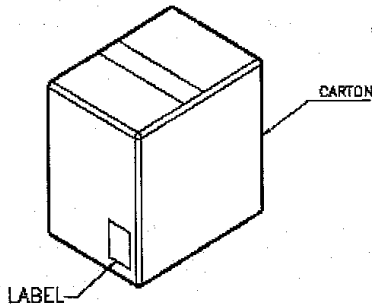

THIS DRAWING IS A CONTROLLED DOCUMENT.		DW H. HUANG S. HOU W. KE	25/04/2009 25/04/2009 25/04/2009	Tyco Holdings (Bermuda) VI Ltd. Taiwan Branch
DIMENSIONS: MM 	TOLERANCES UNLESS OTHERWISE SPECIFIED: 0 PLC ± - 1 PLC ± - 2 PLC ± - 3 PLC ± - 4 PLC ± - ANGLES ± -	PRODUCT SPEC APPLICATION SPEC WEIGHT	DIMM DDRII SOCKET 240P WITH TRANSPARENT LATCH SIZE A3 UNIT CODE 00779 DRAWING NO. C-1775427 REGISTERED TO -	CUSTOMER DRAWING SCALE - SHEET 3 OF 3 REV A