

## Excellent Integrated System Limited

Stocking Distributor

Click to view price, real time Inventory, Delivery & Lifecycle Information:

[Micro Commercial Components \(MCC\)](#)  
[ESD5V0J4-TP](#)

For any questions, you can email us directly:

[sales@integrated-circuit.com](mailto:sales@integrated-circuit.com)



Micro Commercial Components

Micro Commercial Components  
20736 Marilla Street Chatsworth  
CA91311  
Phone: (818) 701-4933  
Fax: (818) 701-4939

## Features

- Halogen free available upon request by adding suffix "-HF"
- For sensitive ESD protection
- Excellent clamping capability
- Low leakage
- ESD rating of class 3(>16KV)per Human Body Mode
- For space saving application
- Fast response ,response time less than 1ns.
- Epoxy meets UL 94 V-0 flammability rating
- Moisture Sensitivity Level 1

## Maximum Ratings

- Operating Junction & Storage Temperature: -55°C to +150°C
- Maximum Thermal Resistance; 833°C/W Junction To Ambient

Parameter	Symbol	Limits	unit
IEC61000-4-2(ESD) Air Contact		±30 ±30	KV
ESD Voltage per human body mode per machine mode		16 400	KV V
Power Dissipation(Note 1)	Pd	150	mw
Peak Power Dissipation@8/20us	Ppk	200	W

1.Only 1 diode under power. For all 4 diodes under power, PD will be 25%. Mounted on FR--4 board with min pad.

## Pin Configuration

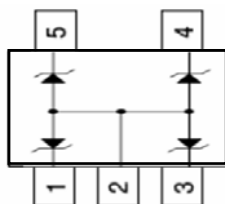

## ESD5V0J4

## 5 Volts ESD Protection Devices

## SOT-353

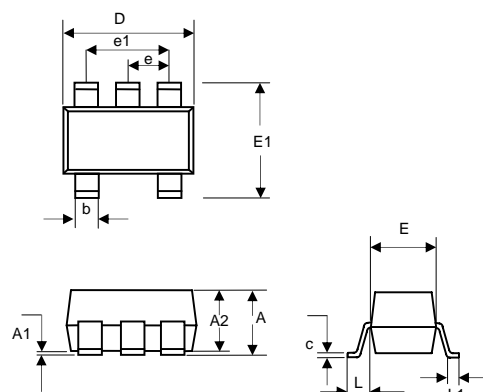

DIM	INCHES		MM	
	MIN	MAX	MIN	MAX
A	.035	.043	0.90	1.10
A1	.00	.004	.00	.100
A2	.035	.039	.900	1.00
b	.006	.014	.150	.350
c	.003	.006	.080	.150
D	.079	.087	2.0	2.2
E	.045	.053	1.15	1.35
E1	.085	.096	2.15	2.45
e	.026 TYP		.650 TYP	
e1	.047	.055	1.2	1.4
L	.021 REF		.525 REF	
L1	.010	.018	.260	.460

**M.C.C.**

Micro Commercial Components

**ELECTRICAL CHARACTERISTICS** ( $T_A = 25^\circ\text{C}$  unless otherwise noted,  $V_F = 0.9\text{ V Max.}$  @  $I_F = 10\text{ mA}$  for all types)

Device*	Device Marking	$V_{RWM}$ (V)	$I_R$ ( $\mu\text{ A}$ ) @ $V_{RWM}$	$V_{BR}$ (V) @ $I_T$		$I_T$	$V_F$ (V) @ $I_F=200\text{ mA}$	$V_C$ (V) @ Max $I_{pp}=5\text{ A}$	C (pF)
		Max	Max	Min	Max	mA	Max	Max	Typ
ESD5V0J4	12	5.0	2	6.0	7.2	1.0	1.25	12.5	90

**TYPICAL CHARACTERISTICS**

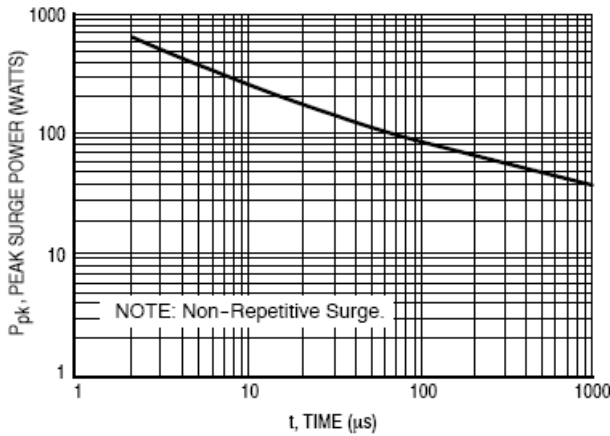

Figure 1. Pulse Width

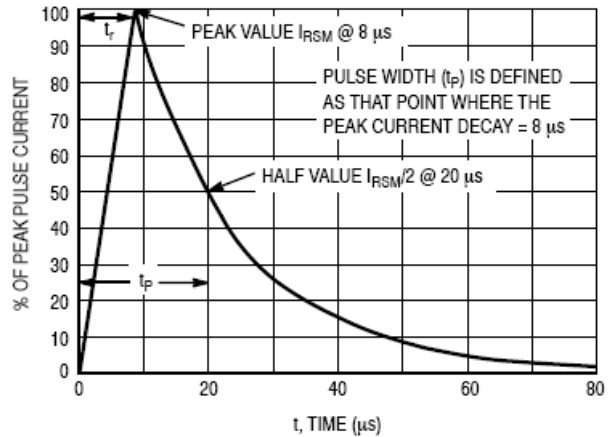
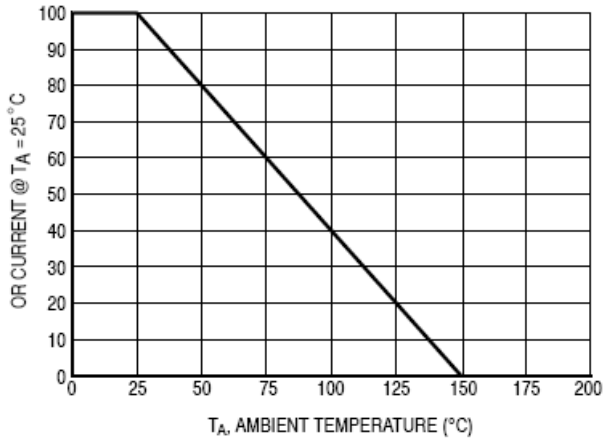

Figure 2.  $8 \times 20\ \mu\text{s}$  Pulse Waveform



**Micro Commercial Components**



**Figure 3. Pulse Derating Curve**

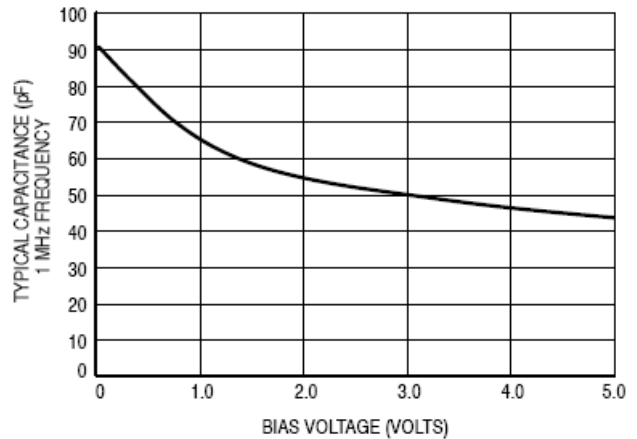

**Figure 4. Capacitance**

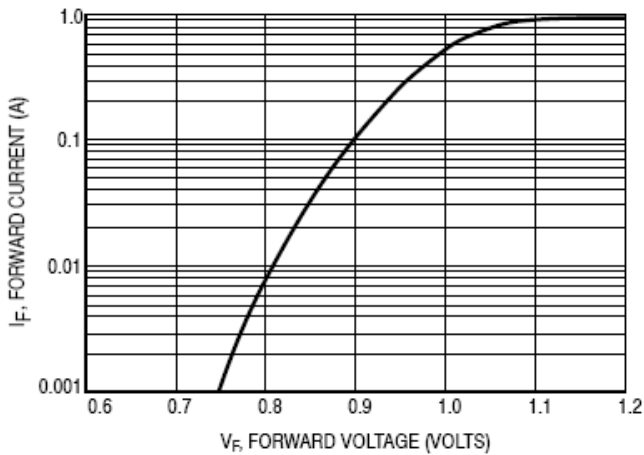

**Figure 5. Forward Voltage**

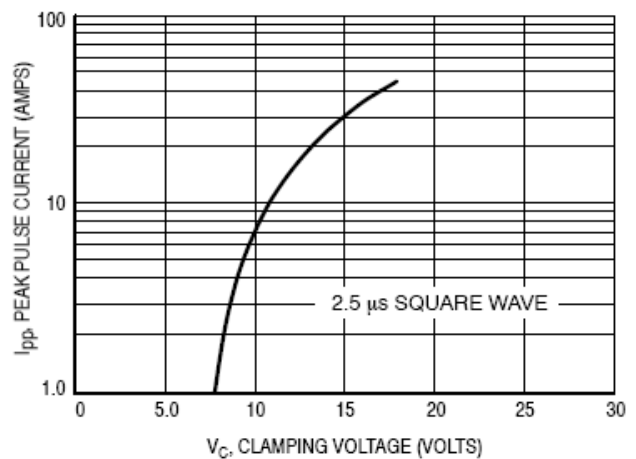

**Figure 6. Clamping Voltage versus Peak Pulse Current (Reverse Direction)**

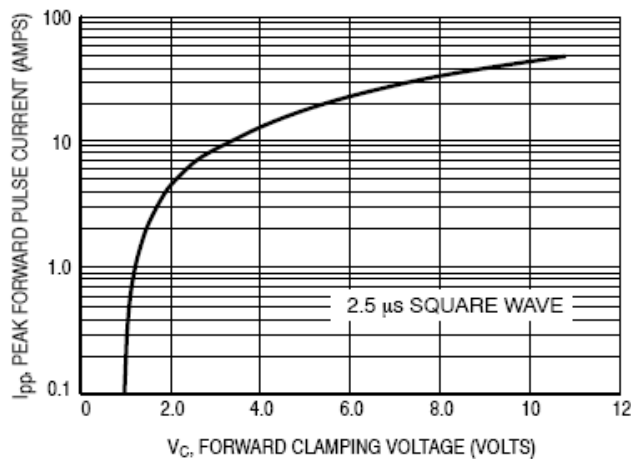

**Figure 7. Clamping Voltage versus Peak Pulse Current (Forward Direction)**



TM

Micro Commercial Components

## Ordering Information :

Device	Packing
Part Number-TP	Tape&Reel: 3Kpcs/Reel

Note : Adding "-HF" suffix for halogen free, eg. Part Number-TP-HF

### \*\*\*IMPORTANT NOTICE\*\*\*

**Micro Commercial Components Corp.** reserves the right to make changes without further notice to any product herein to make corrections, modifications , enhancements , improvements , or other changes . **Micro Commercial Components Corp .** does not assume any liability arising out of the application or use of any product described herein; neither does it convey any license under its patent rights ,nor the rights of others . The user of products in such applications shall assume all risks of such use and will agree to hold **Micro Commercial Components Corp .** and all the companies whose products are represented on our website, harmless against all damages.

### \*\*\*LIFE SUPPORT\*\*\*

MCC's products are not authorized for use as critical components in life support devices or systems without the express written approval of Micro Commercial Components Corporation.

### \*\*\*CUSTOMER AWARENESS\*\*\*

Counterfeiting of semiconductor parts is a growing problem in the industry. Micro Commercial Components (MCC) is taking strong measures to protect ourselves and our customers from the proliferation of counterfeit parts. MCC strongly encourages customers to purchase MCC parts either directly from MCC or from Authorized MCC Distributors who are listed by country on our web page cited below. Products customers buy either from MCC directly or from Authorized MCC Distributors are genuine parts, have full traceability, meet MCC's quality standards for handling and storage. **MCC will not provide any warranty coverage or other assistance for parts bought from Unauthorized Sources.** MCC is committed to combat this global problem and encourage our customers to do their part in stopping this practice by buying direct or from authorized distributors.