

Excellent Integrated System Limited

Stocking Distributor

Click to view price, real time Inventory, Delivery & Lifecycle Information:

[Standex-Meder Electronics](#)
[ORD2211-2030](#)

For any questions, you can email us directly:

sales@integrated-circuit.com

REED SWITCH

ORD2211

Lamp Load

■ GENERAL DESCRIPTION

The ORD2211 is a single-contact reed switch designed for direct opening or closing lamps of 12 V - 3.4 W. The contacts are sealed within the glass tube with inert gas to maintain contact reliability.

■ FEATURES

- (1) Reed contacts are hermetically sealed within a glass tube with inert gas and do not receive any influence from the external atmospheric environment.
- (2) Quick response
- (3) The structure comprises the operating parts and electrical circuits arranged coaxially. Reed switches are suited to applications in radio frequency operation.
- (4) Reed switches are compact and light weight.
- (5) Superior corrosion resistance and wear resistance of the contacts assures stable switching operation and long life.
- (6) With a permanent magnet installed, reed switches economically and easily become proximity switches.

■ EXTERNAL DIMENSIONS (Unit: mm)

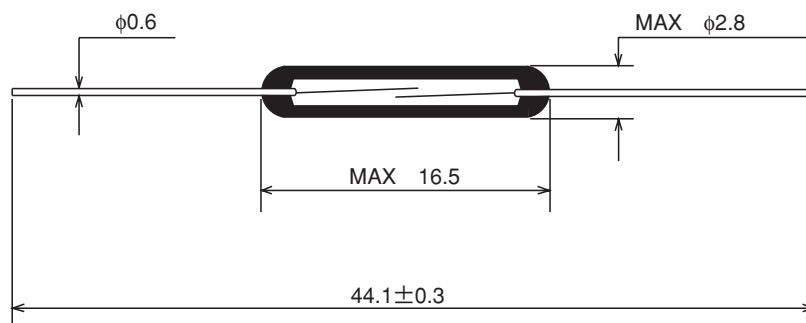

■ APPLICATIONS

- Automotive electronic devices
- Control equipment
- Communication equipment
- Measurement equipment
- Household appliances

● ORD2211

■ ELECTRICAL CHARACTERISTICS

Parameter	Rated value	Unit
Pull-in Value (PI)	20~60	AT
Drop-out Value (DO)	8min	AT
Contact resistance (CR)	100max	mΩ
Breakdown voltage	200min (PI≥20)	VDC
Insulation resistance	10 ⁹ min	Ω
Electrostatic capacitance	0.3max	pF
Contact rating	50 (12V-3.4W lamp)	VA
Maximum switching voltage	100 (^{DC} / _{AC})	V
Maximum switching current	0.5 (Inrush 3A)	A
Maximum carry current	2.5	A

3

(1) Drop-out Value vs. Pull-in Value

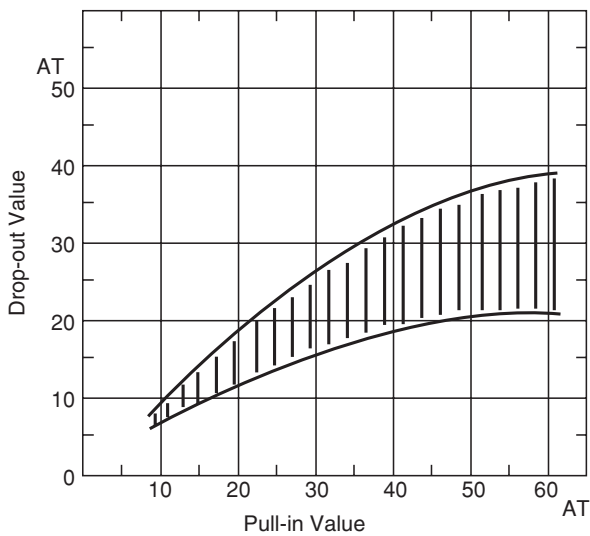

(2) Contact resistance

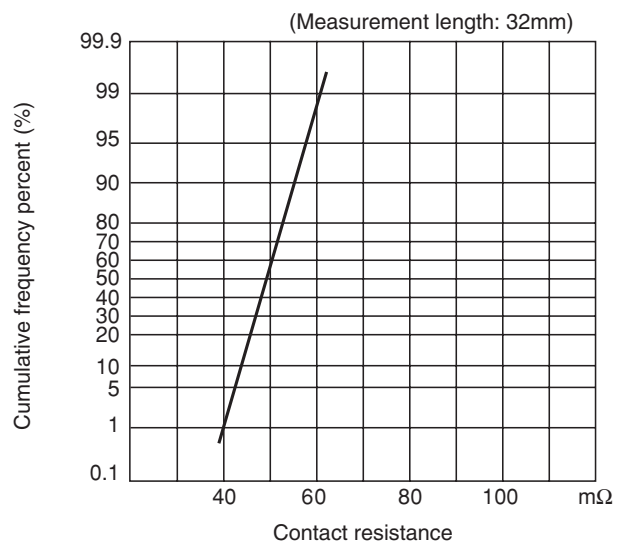

(3) Breakdown voltage

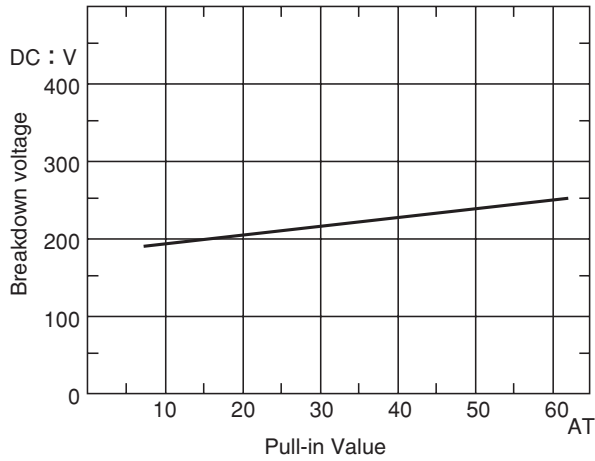

(4) Insulation resistance

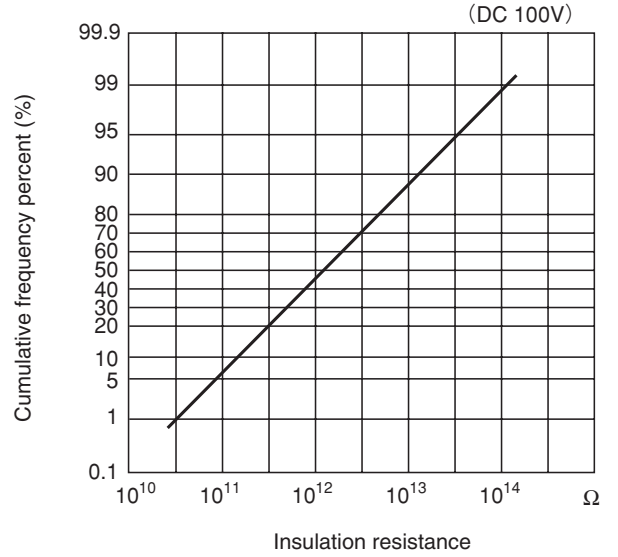

(5) Electrostatic capacitance

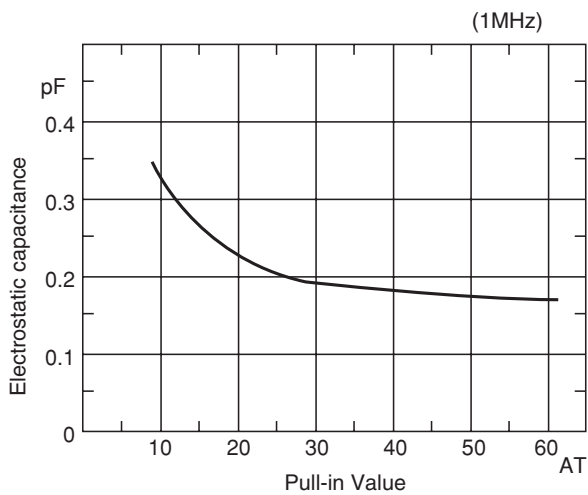

● ORD2211

■ OPERATING CHARACTERISTICS

Parameter	Rated value	Unit
Operate time	0.6max	ms
Bounce time	0.4max	ms
Release time	0.05max	ms
Resonant frequency	4600±500	Hz
Maximum operating frequency	500	Hz

(1) Operate time

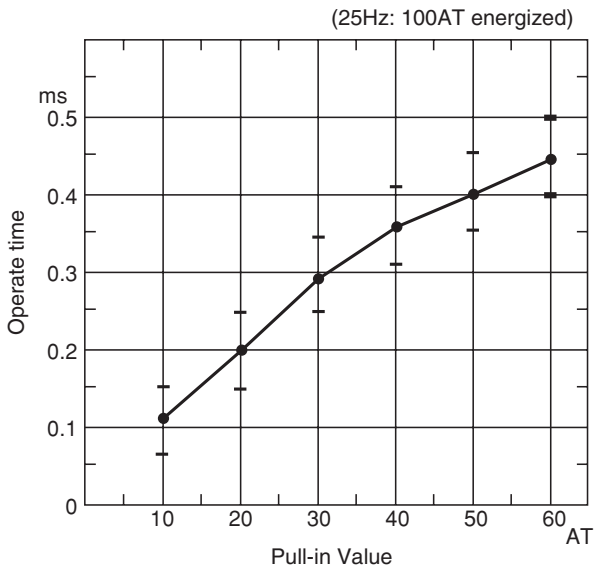

(2) Bounce time

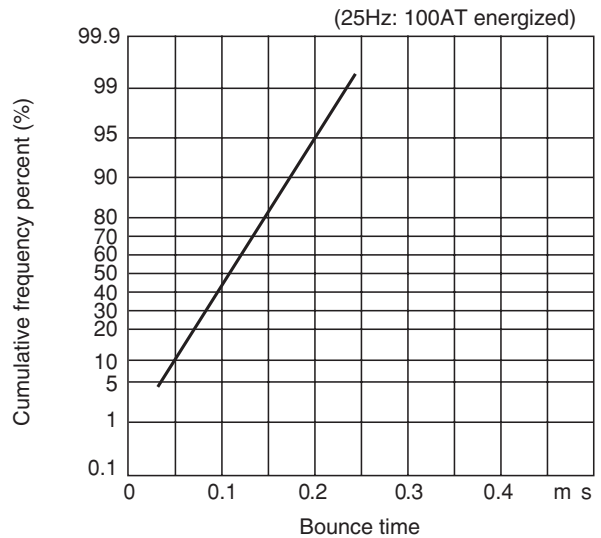

(3) Release time

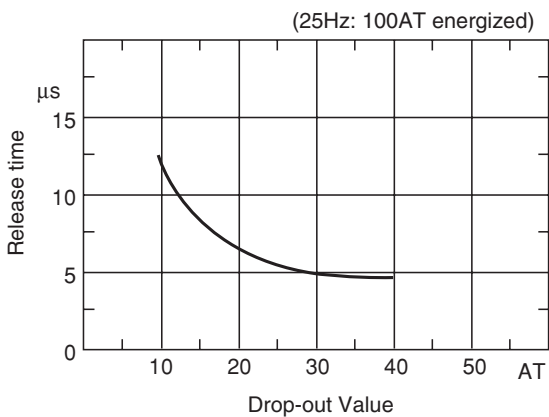

(4) Resonant frequency

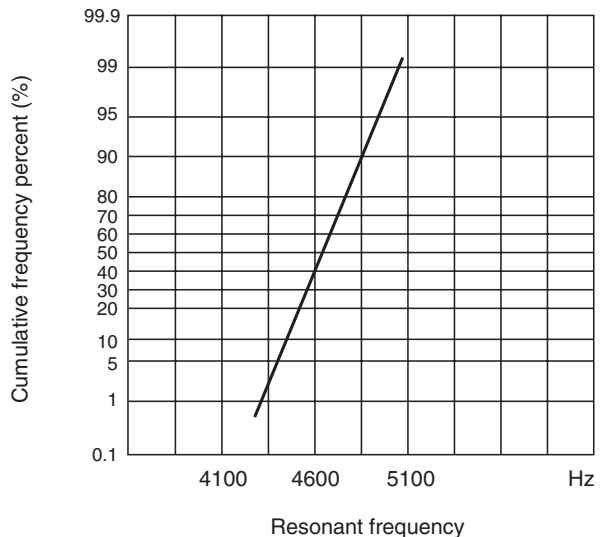

■ MECHANICAL CHARACTERISTICS

(1) Lead tensile test (static load)

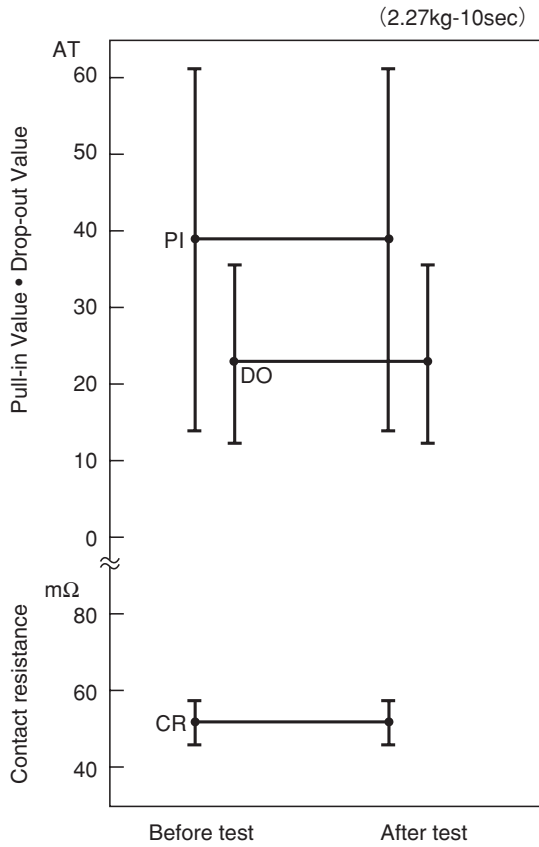

(2) Lead tensile strength

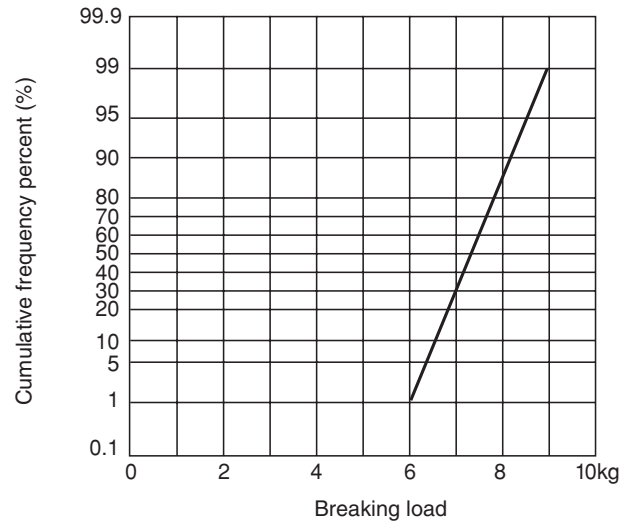

■ ENVIRONMENTAL CHARACTERISTICS

(1) Temperature characteristics

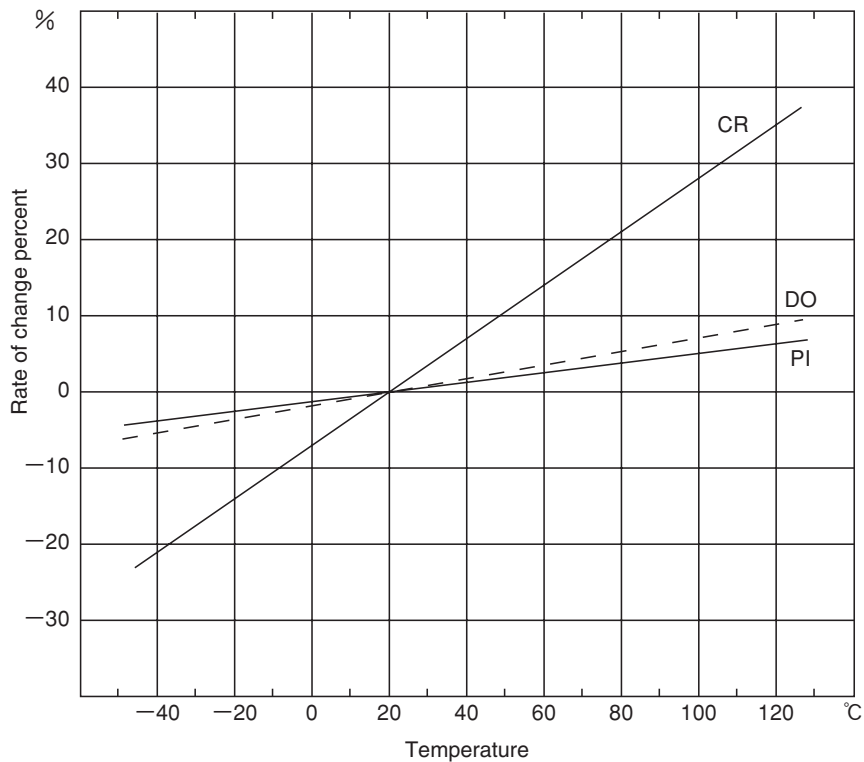

● ORD2211

(2) Temperature cycle

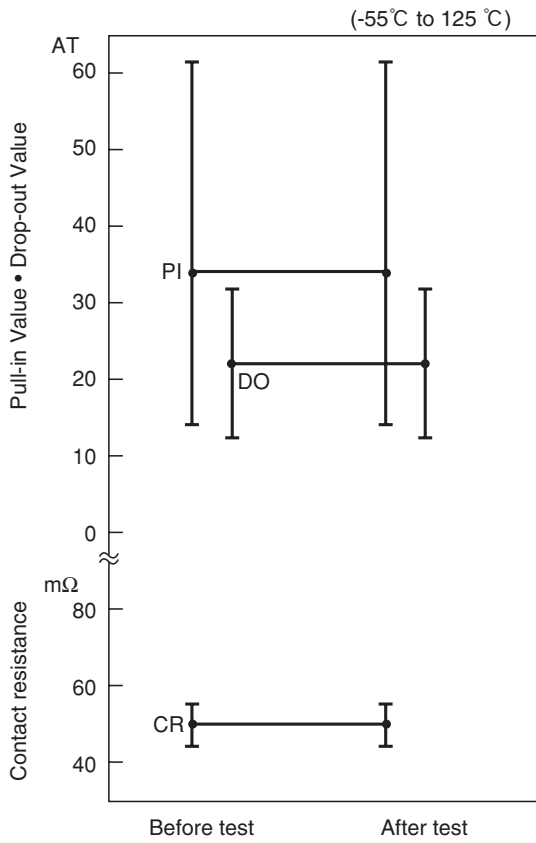

(3) Temperature and humidity cycle

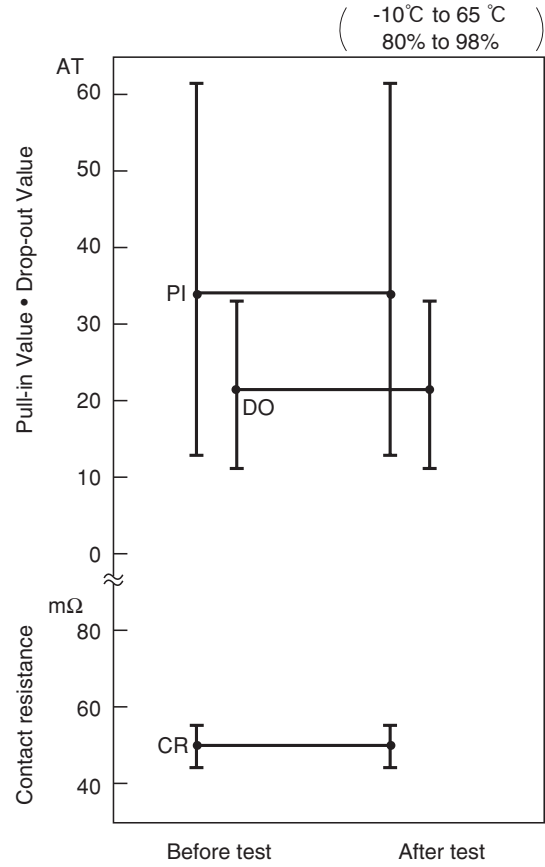

(4) High temperature storage test

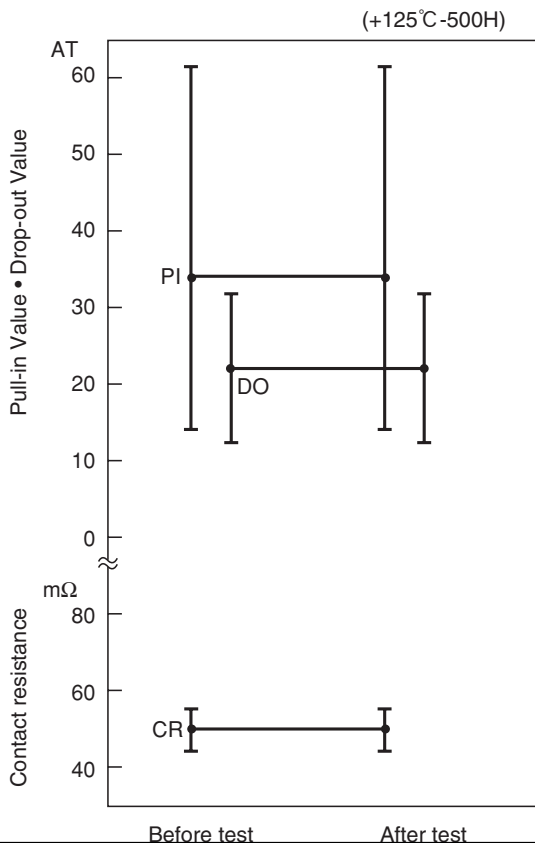

(5) Low temperature storage test

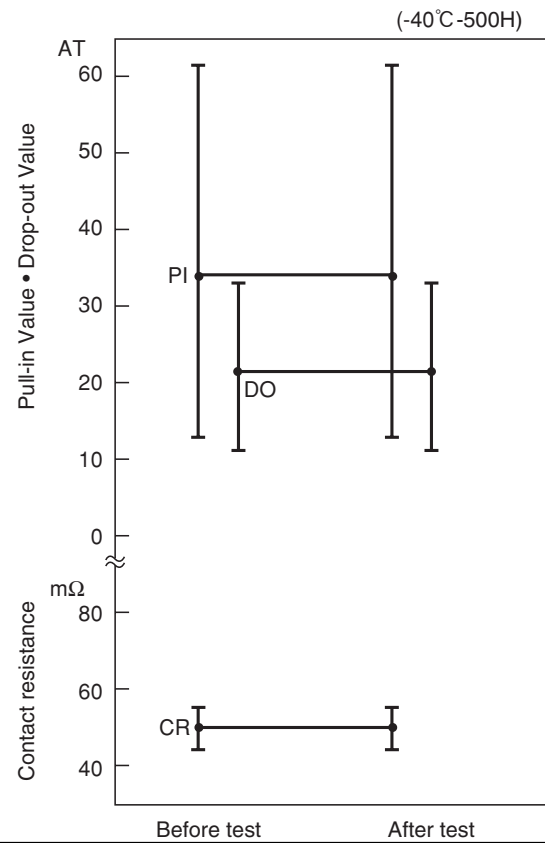

(6) Shock test

1) Electrical characteristics

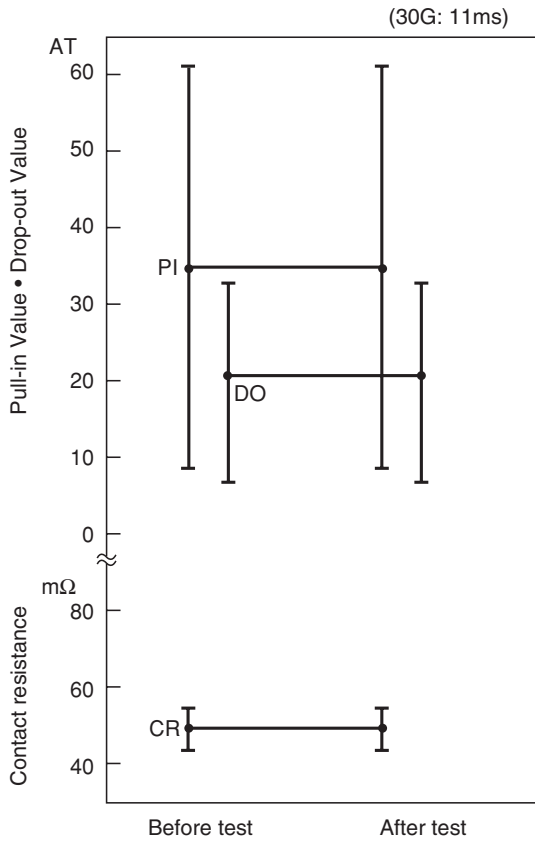

2) Misoperation area

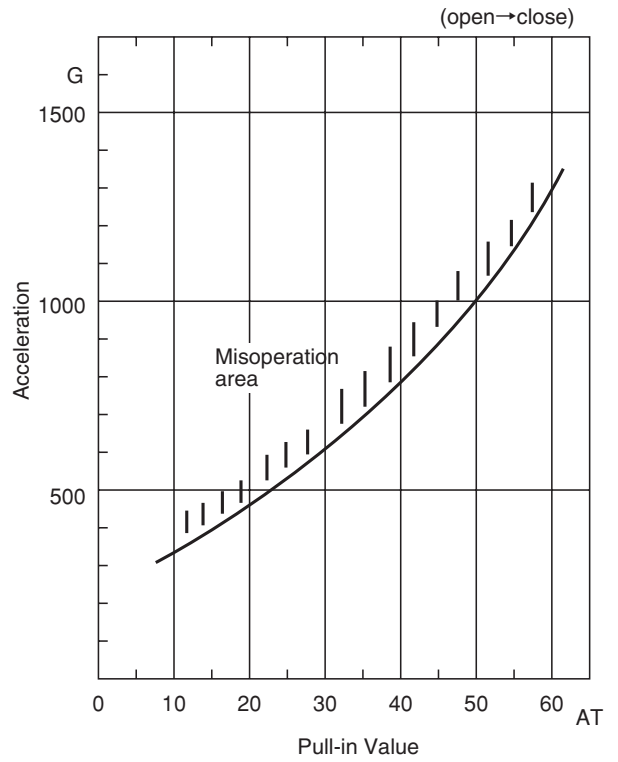

(7) Vibration test

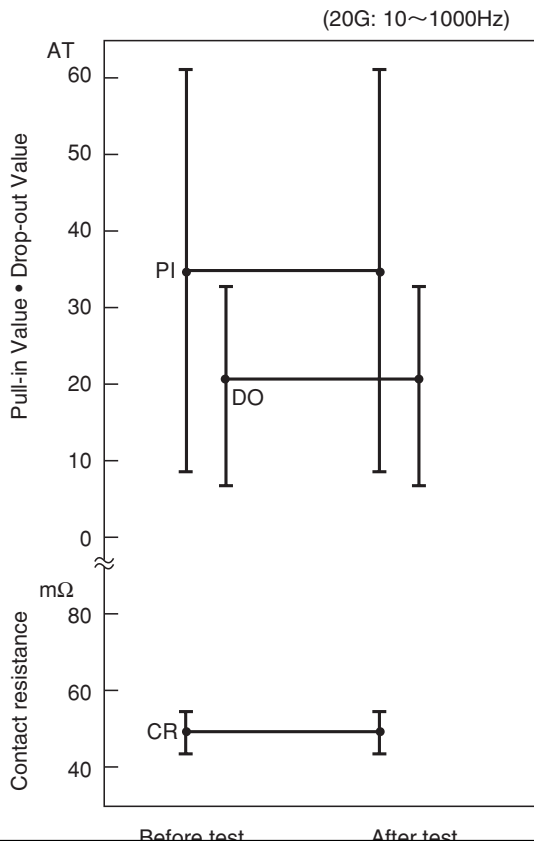

● ORD2211

■ LIFE EXPECTANCY DATA: ORD2211

Load conditions
Voltage: 13, 14, 16 : VDC
Current: 12V-3.4W Lamp

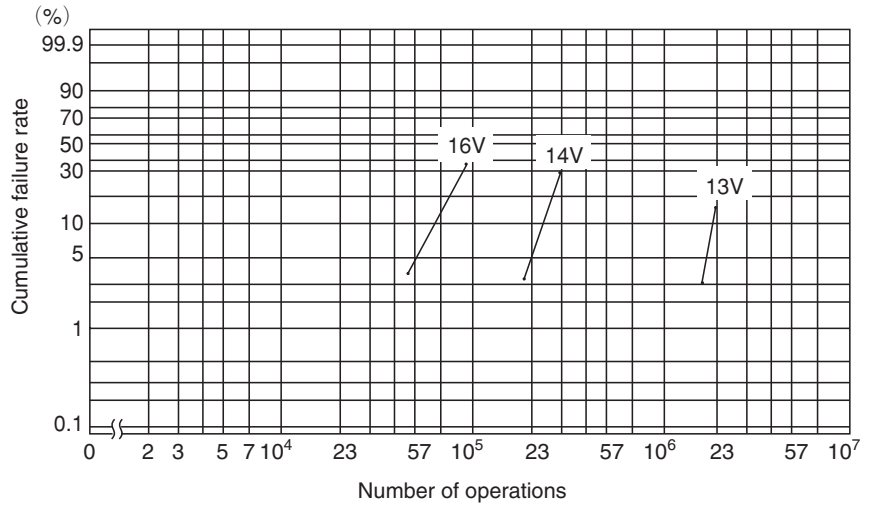

Load conditions
Voltage: 50VDC
Current: 1A
Load: Resistive load

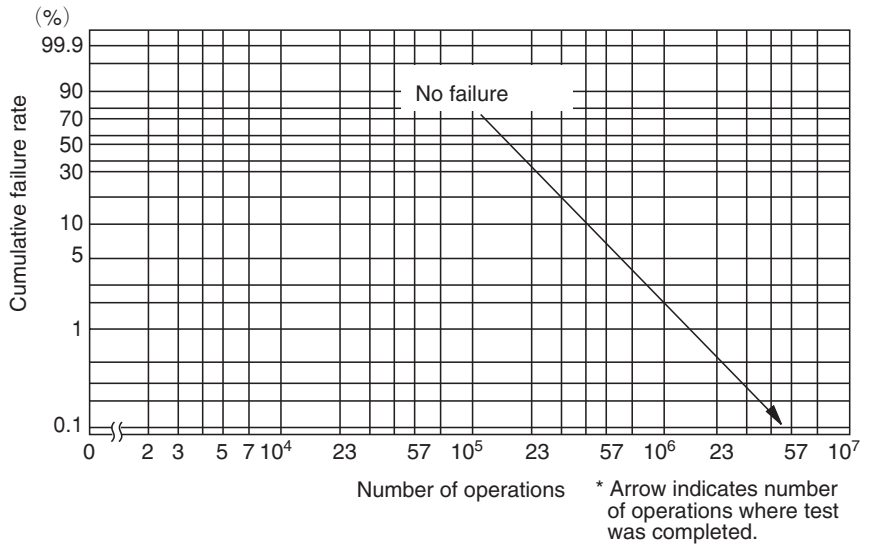

Load conditions
Voltage: 6VDC
Current: 10mA, 50mA
Load: Resistive load

