



Mallory Sonalert Products, Inc.

Part #:

SCH416R

Sales Outline Drawing

Revision:

C

Specifications:

Sound Level Category	Medium
Mode of Operation	Continuous
Voltage Rating	4 to 16 VDC
Frequency	2900 ± 500 Hz
Loudness @ 2 FT	66 to 78 dB(A) Typ.
Current Draw	4-14 mA
Housing Material	6/6 Nylon, Color: Black
Storage Temperature	-40° to +85° C
Operating Temperature	-30° to +65° C
Environmental Approvals	NEMA 3R, 4X & 12; IP-66; CSA C22.2 No. 94; CSA C22.2 No. 213-M1987; Hazardous Loc. Class I, Div II, Grps A, B, C & D
Panel Mounting	Recommended hole size is 1.25"(31.75mm). Thread front will fit standard 30mm(1.181") hole.
Mounting (see note B)	Gasket (included with alarm must be used to ensure compliance to all environmental approvals.
Weight (Typical)	1.6 oz (45g)
Options	Please contact factory.

Dimensions: Inches (mm)

cUL Recognized

ROHS Compliant

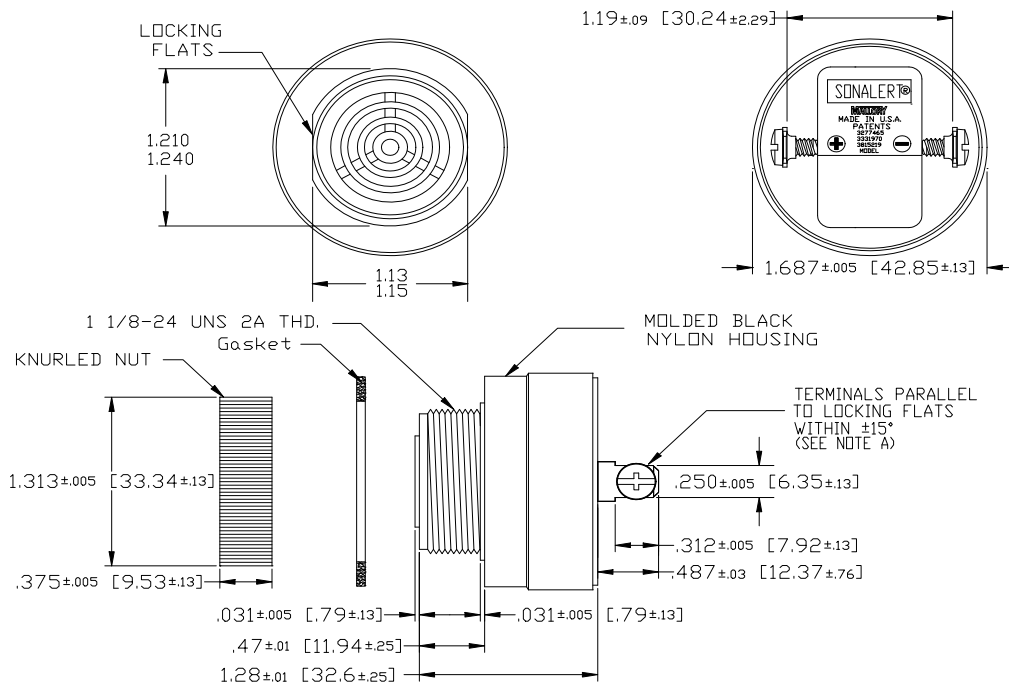

NOTE A: TERMINALS-.032 BRASS TIN PLATED, TAPPED FOR #6-32 SCREW. TWO #6-32 NICKEL PLATED BRASS SCREWS INCLUDED. WILL ACCEPT 1/4" QUICK CONNECT.

NOTE B: MOUNTING- REMOVE BLACK PLASTIC NUT WHILE LEAVING GASKET ON THREADED NECK OF ALARM. INSERT THREADED NECK THROUGH APPROPRIATE SIZED PANEL HOLE. SCREW NUT BACK ONTO THREADED FRONT SECURING ALARM TO PANEL. MAX RECOMMENDED TORQUE IS 10 IN-LBS.