

Excellent Integrated System Limited

Stocking Distributor

Click to view price, real time Inventory, Delivery & Lifecycle Information:

[Molex Connector Corporation](#)
[87715-9105](#)

For any questions, you can email us directly:
sales@integrated-circuit.com

10 9 8 7 6 5 4 3 2 1

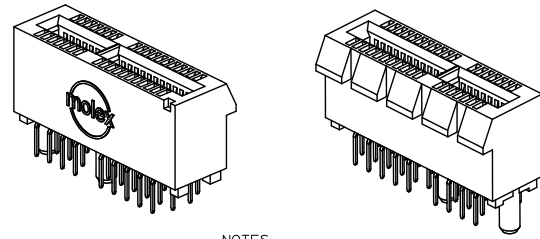
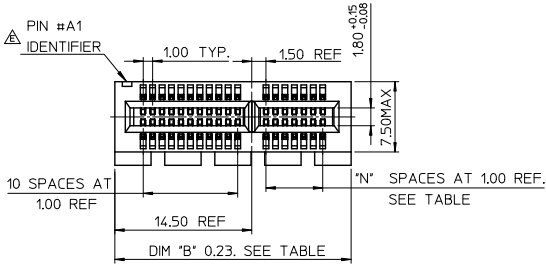

NOTES:

1. MATERIALS:
 - 1-1. HOUSING: SEE TABLE, GLASS FIBER FILLED UL94V-0, COLOR: SEE TABLE.
 - 1-2. CONTACT: SEE TABLE
2. PLATING:
 - 2-1. CONTACT AREA: GOLD, THICKNESS: SEE TABLE.
 - 2-2. SOLDER TAIL: 100 MICRINCH MIN. TIN PLATING.
 - 2-3. UNDER PLATING: NICKEL PLATING OVERALL.
3. WEEK CODE: XX(YEAR) XX(WEEK) X(LOCATION).
4. PRODUCT SPECIFICATION REFER TO PS-87715-200.
5. PACKAGING SPECIFICATION REFER TO PK-87715-207.
6. TEST SUMMARY REFER TO TS-87715-207.
7. LEAD FREE AND ROHS COMPLIANCE PRODUCT.

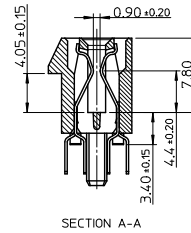
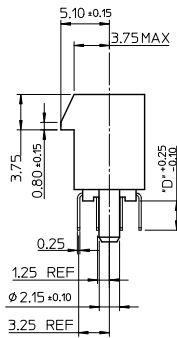
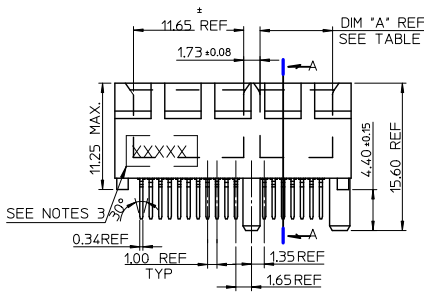

SECTION A-A

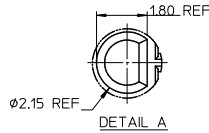
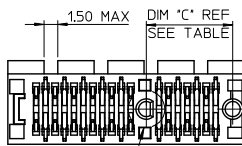

CONNECTOR LINK WIDTH	# POS REF	N	DIM 'A' REF	DIM 'B' REF	DIM 'C' REF
X1	36	6	7.65	25.00	9.15
X4	64	20	21.65	39.00	23.15
X8	98	37	38.65	56.00	40.15
X16	164	70	71.65	89.00	73.15

PCB THK (REF)	DIM 'D'
1.60	2.30
1.58	2.54
2.36	3.00

REVISED EC NO: SH2010-0468 H DRAWN: ZHANG 2010/06/15 CHKD: ALLEN LIN 2010/07/20 APPR: X. J. SONG 2010/07/02	QUALITY SYMBOLS √=0 ∇=0 ∇=0	GENERAL TOLERANCES (UNLESS SPECIFIED)		DIMENSION STYLE MM ONLY		SCALE	DESIGN UNITS METRIC	THIRD ANGLE PROJECTION	
				mm	INCH	DRAWN BY	DATE	TITLE	
		4 PLACES ± --- ± ---		TOM	2004/07/20	PCI EXPRESS EDGE CARD CONNECTOR (LEAD FREE VERSION)			
		3 PLACES ± --- ± ---		CHECKED BY	DATE	MOLEX INCORPORATED			
2 PLACES ± 0.25 ± ---		ALLEN LIN	2004/07/20	MATERIAL NO.		DOCUMENT NO.	SHEET NO.		
1 PLACE ± 0.25 ± ---		WILSON	2004/07/20	SEE SHEET 4		SD-87715-207	1 OF 4		
ANGULAR ± 3 °		DRAFT WHERE APPLICABLE MUST REMAIN WITHIN DIMENSIONS		THIS DRAWING CONTAINS INFORMATION THAT IS PROPRIETARY TO MOLEX INCORPORATED AND SHOULD NOT BE USED WITHOUT WRITTEN PERMISSION					

9 8 7 6 5 4 3 2 1

10 9 8 7 6 5 4 3 2 1

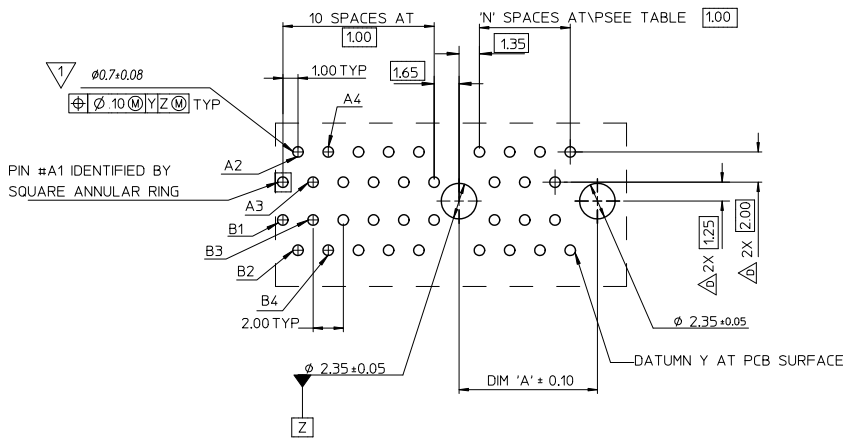

1 THE HORIZONTAL AXIS FOR THE HOLE PATTERN IS ESTABLISHED BY A LINE THROUGH THE CENTER OF THE TWO 2.35 HOLES. THE VERTICAL AXIS IS 90° TO THE HORIZONTAL AXIS, THROUGH THE CENTER OF DATUM Z

CONNECTOR LINK WIDTH	# POS REF	N	DIM 'A'
X1	36	6	9.15
X4	64	20	23.15
X8	98	37	40.15
X16	164	70	73.15

SEE SHEET 1 EC NO: SH2010-0468 DRAWN BY: DRWNRZHANG 2010/06/15 CHKD: ALLEN LIN 2004/07/20 APPR: XJSUNG 2010/07/02	QUALITY SYMBOLS	GENERAL TOLERANCES (UNLESS SPECIFIED)	DIMENSION STYLE	SCALE	DESIGN UNITS	THIRD ANGLE PROJECTION	
		mm INCH	MM ONLY		METRIC		
	√=0 √=0 √=0	4 PLACES ± --- ± --- 3 PLACES ± --- ± --- 2 PLACES ± 0.25 ± --- 1 PLACE ± 0.25 ± --- ANGULAR ± 3 °	DRAWN BY: TOM DATE: 2004/07/20 CHECKED BY: ALLEN LIN DATE: 2004/07/20 APPROVED BY: WILSON DATE: 2004/07/20	TITLE			
		DRAFT WHERE APPLICABLE MUST REMAIN WITHIN DIMENSIONS	MATERIAL NO. SEE SHEET 4	PCI EXPRESS EDGE CARD CONNECTOR (LEAD FREE VERSION) MOLEX INCORPORATED		DOCUMENT NO. SD-87715-207	SHEET NO. 2 OF 4

9 8 7 6 5 4 3 2 1

10 9 8 7 6 5 4 3 2 1

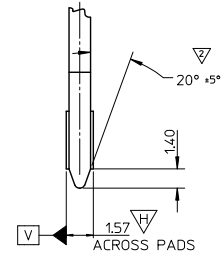
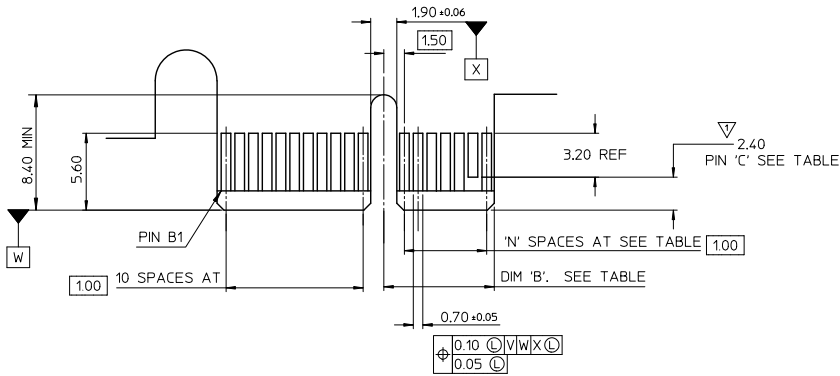

← I/O PANEL DIRECTION

PRIMARY (COMPONENT) SIDE

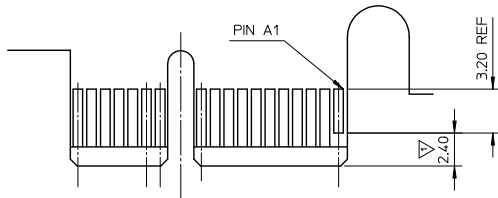

I/O PANEL DIRECTION →

SECONDARY (SOLDER) SIDE

- 1 NO TIE BAR PERMITTED FROM CARD EDGE TO LEADING EDGE OF PAD FOR PINS A1 AND *C*.
- 2 CHAMFER EDGES MUST BE FREE OF CUTTING BURRS.
- 3. TOLERANCE: .XX±.13

CONNECTOR LINK WIDTH	# POS REF	N	DIM 'B'	'C' Δ
X1	36	6	8.15	B17
X4	64	20	22.15	B17, B31
X8	98	37	39.15	B17, B31 B48
X16	164	70	72.15	B17, B31 B48, B81

REV	DESCRIPTION	QUALITY SYMBOLS	GENERAL TOLERANCES (UNLESS SPECIFIED)		DIMENSION STYLE		SCALE	DESIGN UNITS METRIC	THIRD ANGLE PROJECTION
			mm	INCH	MM ONLY	DATE			
1	4 PLACES ± --- ± ---	√/0			DRAWN BY	DATE	TITLE		
2	3 PLACES ± --- ± ---	√/0			TOM	2004/07/20	PCI EXPRESS EDGE CARD CONNECTOR (LEAD FREE VERSION)		
3	2 PLACES ± 0.25 ± ---	√/0			CHECKED BY	DATE	MOLEX INCORPORATED		
4	1 PLACE ± 0.25 ± ---	√/0			ALLEN LIN	2004/07/20			
	ANGULAR ± 3°				APPROVED BY	DATE			
					WILSON	2004/07/20			
					MATERIAL NO.				
					SEE SHEET 4				
					DOCUMENT NO.				
					SD-87715-207				
					SHEET NO.				
					3 OF 4				

9 8 7 6 5 4 3 2 1

10 9 8 7 6 5 4 3 2 1

MOLEX P/N	CIRCUIT SIZE	HOUSING MATERIAL	HOUSING COLOR	TERMINAL MATERIAL	CONTACT PLATING	SOLDER TAIL 'D' LENGTH
87715-9001	36	NYLON46	BLACK	PHOSPHOR BRONZE	10 MICROINCH	2.54
87715-9003					GOLD FLASH	3.00
87715-9004					10 MICROINCH	
87715-9007					GOLD FLASH	2.30
87715-9008					15 MICROINCH	

MOLEX P/N	CIRCUIT SIZE	HOUSING MATERIAL	HOUSING COLOR	TERMINAL MATERIAL	CONTACT PLATING	SOLDER TAIL 'D' LENGTH
87715-9100	64	NYLON46	BLACK	PHOSPHOR BRONZE	GOLD FLASH	2.54
87715-9101					10 MICROINCH	
87715-9102					15 MICROINCH	
87715-9103					GOLD FLASH	3.00
87715-9104					10 MICROINCH	
87715-9105					15 MICROINCH	
87715-9106					30 MICROINCH	2.54
87715-9107					GOLD FLASH	2.30
87715-9108					15 MICROINCH	
87715-9109					30 MICROINCH	

MOLEX P/N	CIRCUIT SIZE	HOUSING MATERIAL	HOUSING COLOR	TERMINAL MATERIAL	CONTACT PLATING	SOLDER TAIL 'D' LENGTH
87715-9200	98	NYLON46	BLACK	PHOSPHOR BRONZE	GOLD FLASH	2.54
87715-9201					10 MICROINCH	
87715-9202					15 MICROINCH	
87715-9203					GOLD FLASH	3.00
87715-9204					10 MICROINCH	
87715-9205					15 MICROINCH	
87715-9206					30 MICROINCH	2.54
87715-9207					GOLD FLASH	2.30
87715-9208					15 MICROINCH	
87715-9209					30 MICROINCH	

MOLEX P/N	CIRCUIT SIZE	HOUSING MATERIAL	HOUSING COLOR	TERMINAL MATERIAL	CONTACT PLATING	SOLDER TAIL 'D' LENGTH
87715-9602	98	NYLON46	BLACK	BRASS	15 MICROINCH	2.54

MOLEX P/N	CIRCUIT SIZE	HOUSING MATERIAL	HOUSING COLOR	TERMINAL MATERIAL	CONTACT PLATING	SOLDER TAIL 'D' LENGTH
87715-9301	164	NYLON46	BLACK	PHOSPHOR BRONZE	10 MICROINCH	2.54
87715-9304					3.00	
87715-9307					GOLD FLASH	2.30
87715-9308					15 MICROINCH	

SEE SHEET 1 EC NO: SH2010-0468 DRAWN BY: H CHKD: ALLEN LIN APPR: XJSJG 2010/06/15 2004/07/20 2010/07/02	QUALITY SYMBOLS $\nabla=0$ $\nabla=0$ $\nabla=0$	GENERAL TOLERANCES (UNLESS SPECIFIED) <table border="1"> <thead> <tr> <th></th> <th>mm</th> <th>INCH</th> </tr> </thead> <tbody> <tr> <td>4 PLACES</td> <td>± ---</td> <td>± ---</td> </tr> <tr> <td>3 PLACES</td> <td>± ---</td> <td>± ---</td> </tr> <tr> <td>2 PLACES</td> <td>± 0.25</td> <td>± ---</td> </tr> <tr> <td>1 PLACE</td> <td>± 0.25</td> <td>± ---</td> </tr> <tr> <td colspan="3">ANGULAR ± 3°</td> </tr> </tbody> </table>		mm	INCH	4 PLACES	± ---	± ---	3 PLACES	± ---	± ---	2 PLACES	± 0.25	± ---	1 PLACE	± 0.25	± ---	ANGULAR ± 3°			DIMENSION STYLE MM ONLY DRAWN BY: TOM DATE: 2004/07/20 CHECKED BY: ALLEN LIN DATE: 2004/07/20 APPROVED BY: WILSON DATE: 2004/07/20	SCALE: _____ DESIGN UNITS: METRIC THIRD ANGLE PROJECTION	TITLE: PCI EXPRESS EDGE CARD CONNECTOR (LEAD FREE VERSION) MOLEX INCORPORATED
		mm	INCH																				
	4 PLACES	± ---	± ---																				
	3 PLACES	± ---	± ---																				
2 PLACES	± 0.25	± ---																					
1 PLACE	± 0.25	± ---																					
ANGULAR ± 3°																							
		DRAFT WHERE APPLICABLE MUST REMAIN WITHIN DIMENSIONS	MATERIAL NO.: SEE TABLE DOCUMENT NO.: SD-87715-207	SHEET NO.: 4 OF 4																			
			THIS DRAWING CONTAINS INFORMATION THAT IS PROPRIETARY TO MOLEX INCORPORATED AND SHOULD NOT BE USED WITHOUT WRITTEN PERMISSION																				

9 8 7 6 5 4 3 2 1