

Excellent Integrated System Limited

Stocking Distributor

Click to view price, real time Inventory, Delivery & Lifecycle Information:

[Powerex Inc.](#)
[CM200DY-28H](#)

For any questions, you can email us directly:

sales@integrated-circuit.com



Powerex, Inc., 200 Hillis Street, Youngwood, Pennsylvania 15697-1800 (724) 925-7272

CM200DY-28H

**Dual IGBTMOD™
H-Series Module
200 Amperes/1400 Volts**

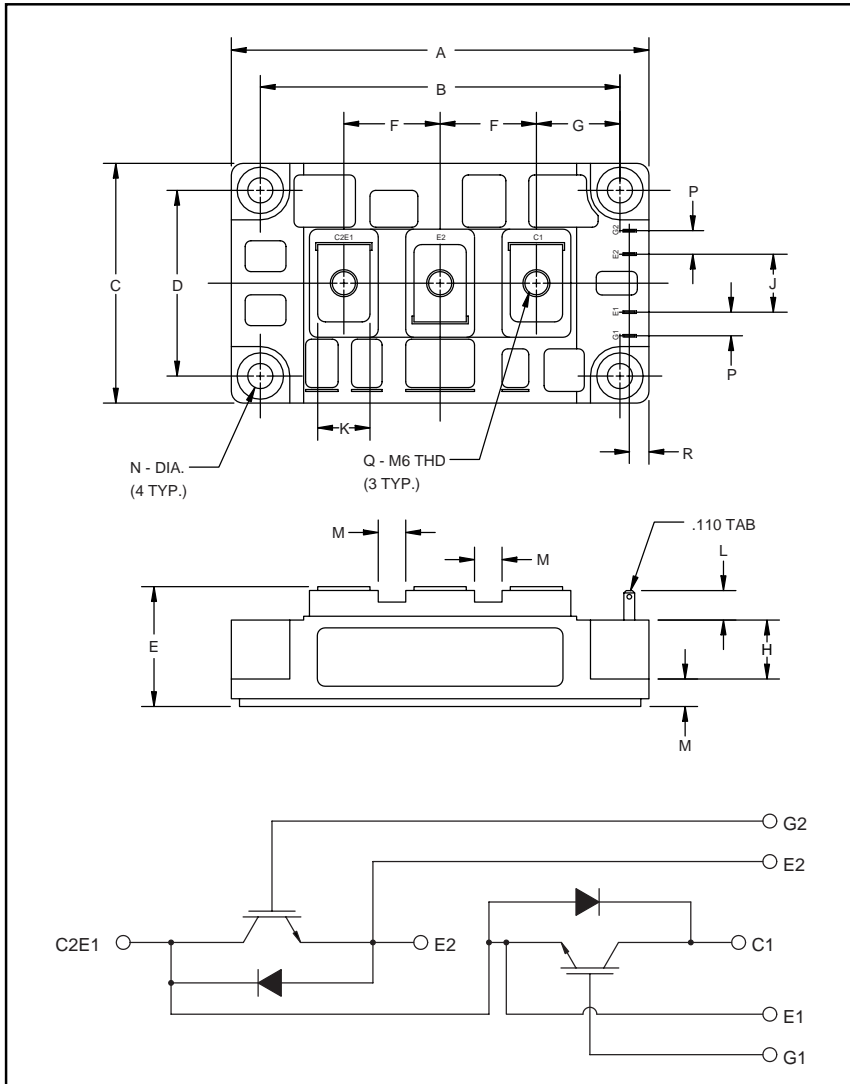

Outline Drawing and Circuit Diagram

| Dimensions | Inches | Millimeters |
|------------|-----------|-------------|
| A | 4.25 | 108.0 |
| B | 3.66±0.01 | 93.0±0.25 |
| C | 2.44 | 62.0 |
| D | 1.89±0.01 | 48.0±0.25 |
| E | 1.22 Max. | 31.0 Max. |
| F | 0.98 | 25.0 |
| G | 0.85 | 21.5 |
| H | 0.60 | 15.2 |

| Dimensions | Inches | Millimeters |
|------------|------------|-------------|
| J | 0.59 | 15.0 |
| K | 0.55 | 14.0 |
| L | 0.30 | 8.5 |
| M | 0.28 | 7.0 |
| N | 0.256 Dia. | Dia. 6.5 |
| P | 0.24 | 6.0 |
| Q | M6 Metric | M6 |
| R | 0.20 | 5.0 |



Description:

Powerex IGBTMOD™ Modules are designed for use in switching applications. Each module consists of two IGBT Transistors in a half-bridge configuration with each transistor having a reverse-connected super-fast recovery free-wheel diode. All components and interconnects are isolated from the heat sinking baseplate, offering simplified system assembly and thermal management.

Features:

- Low Drive Power
- Low $V_{CE(sat)}$
- Discrete Super-Fast Recovery (135ns) Free-Wheel Diode
- High Frequency Operation (20-25kHz)
- Isolated Baseplate for Easy Heat Sinking

Applications:

- AC Motor Control
- Motion/Servo Control
- UPS
- Welding Power Supplies
- Laser Power Supplies

Ordering Information:

Example: Select the complete part module number you desire from the table below -i.e. CM200DY-28H is a 1400V (V_{CES}), 200 Ampere Dual IGBTMOD™ Power Module.

| Type | Current Rating Amperes | V_{CES} Volts (x 50) |
|------|---------------------------|---------------------------|
| CM | 200 | 28 |



Powerex, Inc., 200 Hillis Street, Youngwood, Pennsylvania 15697-1800 (724) 925-7272

CM200DY-28H
Dual IGBTMOD™ H-Series Module
 200 Amperes/1400 Volts

Absolute Maximum Ratings, $T_j = 25\text{ }^\circ\text{C}$ unless otherwise specified

| Ratings | Symbol | CM200DY-28H | Units |
|---|------------------|-------------|------------------|
| Junction Temperature | T_j | -40 to 150 | $^\circ\text{C}$ |
| Storage Temperature | T_{stg} | -40 to 125 | $^\circ\text{C}$ |
| Collector-Emitter Voltage (G-E SHORT) | V_{CES} | 1400 | Volts |
| Gate-Emitter Voltage | V_{GES} | ± 20 | Volts |
| Collector Current | I_C | 200 | Amperes |
| Peak Collector Current | I_{CM} | 400* | Amperes |
| Diode Forward Current | I_F | 200 | Amperes |
| Diode Forward Surge Current | I_{FM} | 400* | Amperes |
| Power Dissipation | P_d | 1500 | Watts |
| Max. Mounting Torque M6 Terminal Screws | - | 26 | in-lb |
| Max. Mounting Torque M6 Mounting Screws | - | 26 | in-lb |
| Module Weight (Typical) | - | 400 | Grams |
| V Isolation | V_{RMS} | 2500 | Volts |

* Pulse width and repetition rate should be such that device junction temperature does not exceed the device rating.

Static Electrical Characteristics, $T_j = 25\text{ }^\circ\text{C}$ unless otherwise specified

| Characteristics | Symbol | Test Conditions | Min. | Typ. | Max. | Units |
|--------------------------------------|----------------------|--|------|------|-------|---------------|
| Collector-Cutoff Current | I_{CES} | $V_{\text{CE}} = V_{\text{CES}}, V_{\text{GE}} = 0\text{V}$ | - | - | 1.0 | mA |
| Gate Leakage Current | I_{GES} | $V_{\text{GE}} = V_{\text{GES}}, V_{\text{CE}} = 0\text{V}$ | - | - | 0.5 | μA |
| Gate-Emitter Threshold Voltage | $V_{\text{GE(th)}}$ | $I_C = 20\text{mA}, V_{\text{CE}} = 10\text{V}$ | 5.0 | 6.5 | 8.0 | Volts |
| Collector-Emitter Saturation Voltage | $V_{\text{CE(sat)}}$ | $I_C = 200\text{A}, V_{\text{GE}} = 15\text{V}$ | - | 3.1 | 4.2** | Volts |
| | | $I_C = 200\text{A}, V_{\text{GE}} = 15\text{V}, T_j = 150\text{ }^\circ\text{C}$ | - | 2.95 | - | Volts |
| Total Gate Charge | Q_G | $V_{\text{CC}} = 800\text{V}, I_C = 200\text{A}, V_{\text{GE}} = 15\text{V}$ | - | 1020 | - | nC |
| Diode Forward Voltage | V_{FM} | $I_E = 200\text{A}, V_{\text{GE}} = 0\text{V}$ | - | - | 3.8 | Volts |

** Pulse width and repetition rate should be such that device junction temperature rise is negligible.

Dynamic Electrical Characteristics, $T_j = 25\text{ }^\circ\text{C}$ unless otherwise specified

| Characteristics | Symbol | Test Conditions | Min. | Typ. | Max. | Units |
|-------------------------------|---------------------|--|------|------|------|---------------|
| Input Capacitance | C_{ies} | | - | - | 40 | nF |
| Output Capacitance | C_{oes} | $V_{\text{GE}} = 0\text{V}, V_{\text{CE}} = 10\text{V}, f = 1\text{MHz}$ | - | - | 14 | nF |
| Reverse Transfer Capacitance | C_{res} | | - | - | 8 | nF |
| Resistive | Turn-on Delay Time | $t_{\text{d(on)}}$ | - | - | 250 | ns |
| Load | Rise Time | t_r | - | - | 400 | ns |
| Switching | Turn-off Delay Time | $t_{\text{d(off)}}$ | - | - | 300 | ns |
| | Fall Time | t_f | - | - | 500 | ns |
| Diode Reverse Recovery Time | t_{rr} | $I_E = 200\text{A}, di_E/dt = -400\text{A}/\mu\text{s}$ | - | - | 300 | ns |
| Diode Reverse Recovery Charge | Q_{rr} | $I_E = 200\text{A}, di_E/dt = -400\text{A}/\mu\text{s}$ | - | 2.0 | - | μC |

Thermal and Mechanical Characteristics, $T_j = 25\text{ }^\circ\text{C}$ unless otherwise specified

| Characteristics | Symbol | Test Conditions | Min. | Typ. | Max. | Units |
|--------------------------------------|----------------------|------------------------------------|------|------|-------|---------------------------|
| Thermal Resistance, Junction to Case | $R_{\text{th(j-c)}}$ | Per IGBT | - | - | 0.085 | $^\circ\text{C}/\text{W}$ |
| Thermal Resistance, Junction to Case | $R_{\text{th(j-c)}}$ | Per FWDi | - | - | 0.18 | $^\circ\text{C}/\text{W}$ |
| Contact Thermal Resistance | $R_{\text{th(c-f)}}$ | Per Module, Thermal Grease Applied | - | - | 0.045 | $^\circ\text{C}/\text{W}$ |



Powerex, Inc., 200 Hillis Street, Youngwood, Pennsylvania 15697-1800 (724) 925-7272

CM200DY-28H
Dual IGBTMOD™ H-Series Module
 200 Amperes/1400 Volts

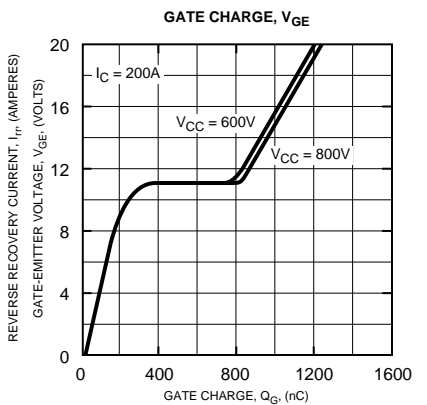
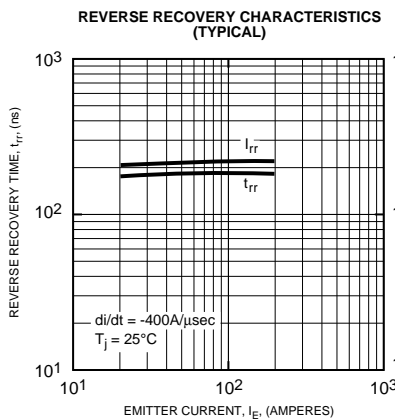
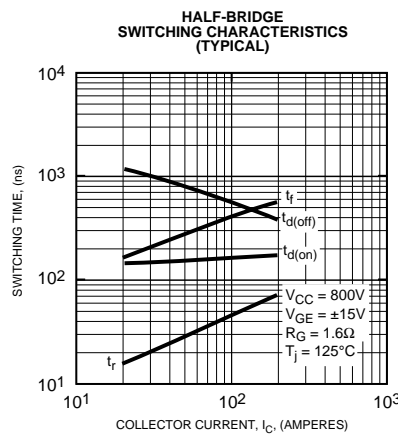
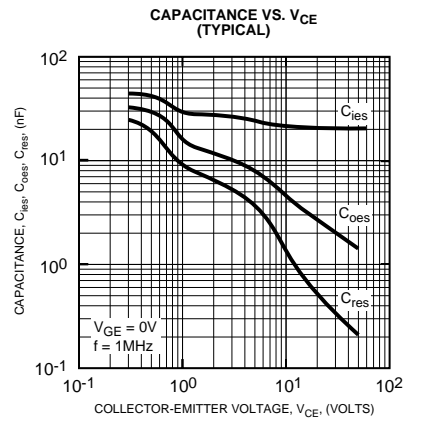
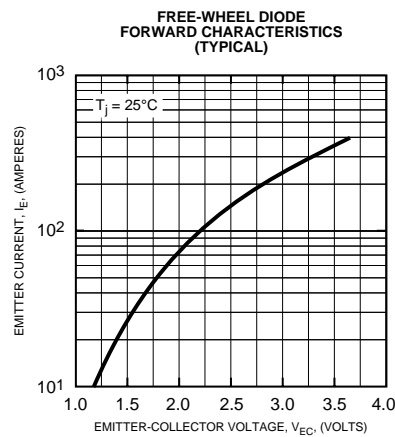
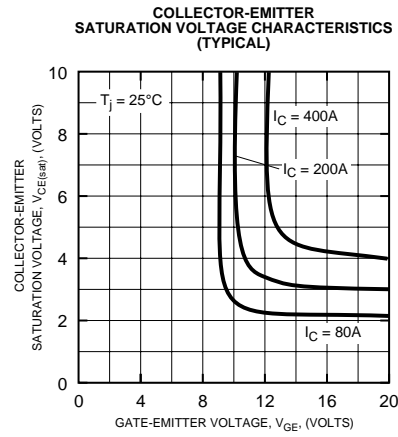
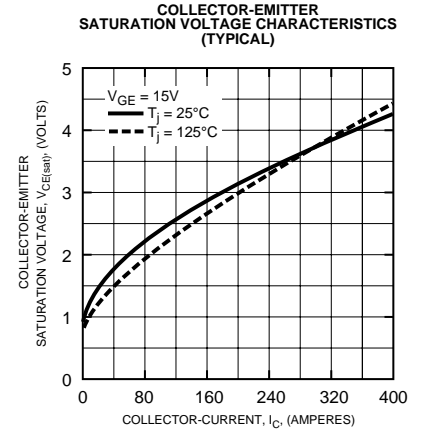
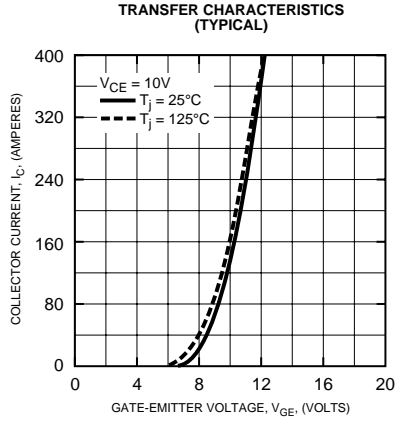
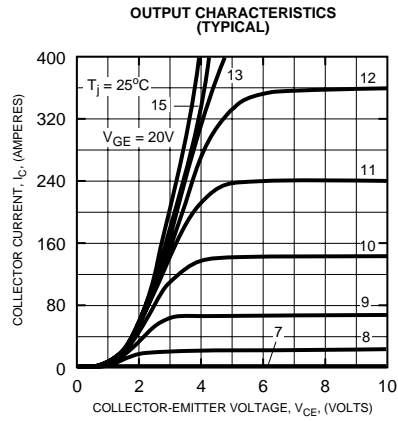



Powerex, Inc., 200 Hillis Street, Youngwood, Pennsylvania 15697-1800 (724) 925-7272

CM200DY-28H
Dual IGBTMOD™ H-Series Module
 200 Amperes/1400 Volts

