

Excellent Integrated System Limited

Stocking Distributor

Click to view price, real time Inventory, Delivery & Lifecycle Information:

[Hammond Manufacturing](#)
[RM2095S](#)

For any questions, you can email us directly:

sales@integrated-circuit.com

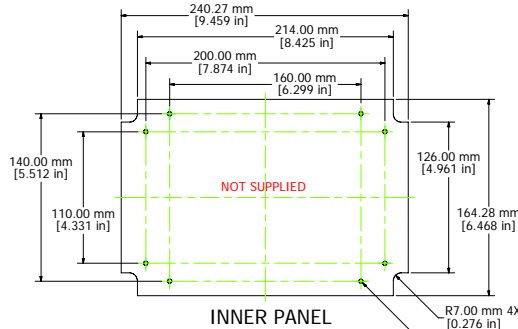
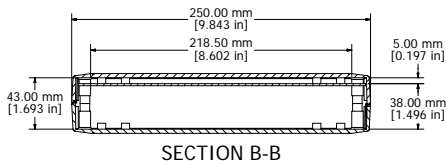
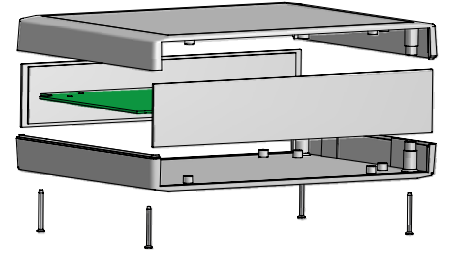
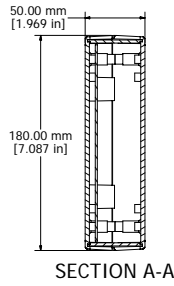
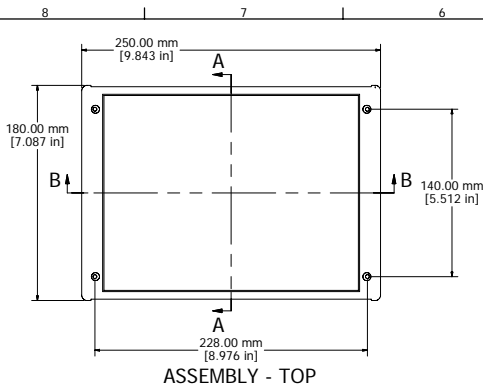

Enclosures can be Factory Modified (Milling, Drilling, Printing etc.)
Contact Factory mjm@hammondmfg.com for quotes
Solid models of this enclosure available in STEP or IGES.

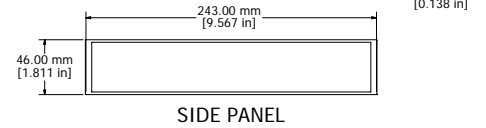
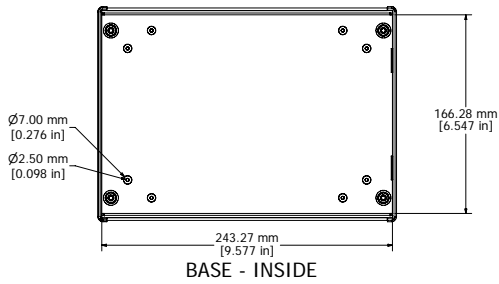

RM2095S
Material: ABS (UL94-HB), Light Gray color
Lid Screws: M3 x 30
Circuit Board Screws, 4 Supplied (M3 self tap)
Suggested Lid Screw Torque: 30 ozf-in (21 cN-m)

