

Excellent Integrated System Limited

Stocking Distributor

Click to view price, real time Inventory, Delivery & Lifecycle Information:

[Vishay Semiconductor/Diodes Division](#)
[SMA5J10-E3/5A](#)

For any questions, you can email us directly:

sales@integrated-circuit.com



www.vishay.com

SMA5J5.0A thru SMA5J40CA

Vishay General Semiconductor

High Power Density Surface Mount TRANSZORB® Transient Voltage Suppressors



DO-214AC (SMA)

PRIMARY CHARACTERISTICS	
V_{BR}	6.4 V to 49.1 V
V_{WM}	5.0 V to 40 V
P_{PPM}	500 W
I_{FSM} (uni-directional only)	40 A
T_J max.	150 °C
Polarity	Uni-directional, bi-directional
Package	DO-214AC (SMBA)

DEVICES FOR BI-DIRECTION APPLICATIONS

For bi-directional devices use CA suffix (e.g. SMA5J40CA).

Electrical characteristics apply in both directions.

FEATURES

- Low profile package
- Ideal for automated placement
- Glass passivated chip junction
- Available in uni-directional and bi-directional
- Excellent clamping capability
- Very fast response time
- Low incremental surge resistance
- Meets MSL level 1, per J-STD-020, LF maximum peak of 260 °C
- AEC-Q101 qualified
- Material categorization: For definitions of compliance please see www.vishay.com/doc?99912



RoHS
COMPLIANT

TYPICAL APPLICATIONS

Use in sensitive electronics protection against voltage transients induced by inductive load switching and lighting on ICs, MOSFET, signal lines of sensor units for consumer, computer, industrial, automotive, and telecommunication.

MECHANICAL DATA

Case: DO-214AC (SMA)

Molding compound meets UL 94 V-0 flammability rating
Base P/N-E3 - RoHS compliant, commercial grade
Base P/NHE3 - RoHS compliant, AEC-Q101 qualified

Terminals: Matte tin plated leads, solderable per J-STD-002 and JESD 22-B102

E3 suffix meets JESD 201 class 1A whisker test, HE3 suffix meets JESD 201 class 2 whisker test

Polarity: For uni-directional types the band denotes cathode end, no marking on bi-directional types

MAXIMUM RATINGS ($T_A = 25\text{ °C}$ unless otherwise noted)			
PARAMETER	SYMBOL	VALUE	UNIT
Peak pulse power dissipation with a 10/1000 μ s waveform ⁽¹⁾⁽²⁾ (fig. 1)	P_{PPM}	500	W
Peak pulse current with a 10/1000 μ s waveform ⁽¹⁾	I_{PPM}	See next table	A
Peak forward surge current 8.3 ms single half sine-wave uni-directional only ⁽²⁾	I_{FSM}	40	A
Operating junction and storage temperature range	T_J, T_{STG}	- 55 to + 150	°C

Notes

⁽¹⁾ Non-repetitive current pulse, per fig. 3 and derated above $T_A = 25\text{ °C}$ per fig. 2.

⁽²⁾ Mounted on 0.2" x 0.2" (5.0 mm x 5.0 mm) copper pads to each terminal



www.vishay.com

SMA5J5.0A thru SMA5J40CA

Vishay General Semiconductor

ELECTRICAL CHARACTERISTICS (T _A = 25 °C unless otherwise noted)									
DEVICE TYPE	DEVICE MARKING CODE		BREAKDOWN VOLTAGE V _{BR} (V) ⁽¹⁾		TEST CURRENT I _T (mA)	STAND-OFF VOLTAGE V _{WM} (V)	MAXIMUM REVERSE LEAKAGE AT V _{WM} I _D (μA) ⁽³⁾	MAXIMUM PEAK PULSE SURGE CURRENT I _{PPM} (A) ⁽²⁾	MAXIMUM CLAMPING VOLTAGE AT I _{PPM} V _C (V)
	UNI	BI	MIN.	MAX.					
SMA5J5.0A ⁽⁵⁾	5AE	5AE	6.40	7.07	10	5.0	800	54.3	9.2
SMA5J6.0A	5AG	5AG	6.67	7.37	10	6.0	800	48.5	10.3
SMA5J6.5A	5AK	5AK	7.22	7.98	10	6.5	500	44.6	11.2
SMA5J7.0A	5AM	5AM	7.78	8.60	10	7.0	200	41.7	12.0
SMA5J7.5A	5AP	5AP	8.33	9.21	1.0	7.5	100	38.8	12.9
SMA5J8.0A	5AR	5AR	8.89	9.83	1.0	8.0	50	36.8	13.6
SMA5J8.5A	5AT	5AT	9.44	10.4	1.0	8.5	10	34.7	14.4
SMA5J9.0A	5AV	5AV	10.0	11.1	1.0	9.0	5.0	32.5	15.4
SMA5J10A	5AX	5AX	11.1	12.3	1.0	10	1.0	29.4	17.0
SMA5J11A	5AZ	5AZ	12.2	13.5	1.0	11	1.0	27.5	18.2
SMA5J12A	5BE	5BE	13.3	14.7	1.0	12	1.0	25.1	19.9
SMA5J13A	5BG	5BG	14.4	15.9	1.0	13	1.0	23.3	21.5
SMA5J14A	5BK	5BK	15.6	17.2	1.0	14	1.0	21.6	23.2
SMA5J15A	5BM	5BM	16.7	18.5	1.0	15	1.0	20.5	24.4
SMA5J16A	5BP	5BP	17.8	19.7	1.0	16	1.0	19.2	26.0
SMA5J17A	5BR	5BR	18.9	20.9	1.0	17	1.0	18.1	27.6
SMA5J18A	5BT	5BT	20.0	22.1	1.0	18	1.0	17.1	29.2
SMA5J20A	5BV	5BV	22.2	24.5	1.0	20	1.0	15.4	32.4
SMA5J22A	5BX	5BX	24.4	26.9	1.0	22	1.0	14.1	35.5
SMA5J24A	5BZ	5BZ	26.7	29.5	1.0	24	1.0	12.9	38.9
SMA5J26A	5CE	5CE	28.9	31.9	1.0	26	1.0	11.9	42.1
SMA5J28A	5CG	5CG	31.1	34.4	1.0	28	1.0	11.0	45.4
SMA5J30A	5CK	5CK	33.3	36.8	1.0	30	1.0	10.3	48.4
SMA5J33A	5CM	5CM	36.7	40.6	1.0	33	1.0	9.4	53.3
SMA5J36A	5CP	5CP	40.0	44.2	1.0	36	1.0	8.6	58.1
SMA5J40A	5CR	5CR	44.4	49.1	1.0	40	1.0	7.8	64.5

Notes

- (1) Pulse test: t_p ≤ 50 ms
- (2) Surge current waveform per fig. 3 and derate per fig. 2
- (3) For bi-directional types having V_{WM} of 10 V and less, the I_D limit is doubled
- (4) All terms and symbols are consistent with ANSI/IEEE C62.35
- (5) For the bi-directional SMA5J5.0CA, the maximum V_{BR} is 7.25 V
- (6) V_F = 3.5 V at I_F = 25 A (uni-directional only)

THERMAL CHARACTERISTICS (T _A = 25 °C unless otherwise noted)			
PARAMETER	SYMBOL	VALUE	UNIT
Typical thermal resistance, junction to ambient ⁽¹⁾	R _{θJA}	80	°C/W
Typical thermal resistance, junction to lead	R _{θJL}	25	

Note

- (1) Mounted on minimum recommended pad layout

ORDERING INFORMATION (Example)				
PREFERRED P/N	UNIT WEIGHT (g)	PREFERRED PACKAGE CODE	BASE QUANTITY	DELIVERY MODE
SMA5J5.0A-E3/61	0.064	61	1800	7" diameter plastic tape and reel
SMA5J5.0A-E3/5A	0.064	5A	7500	13" diameter plastic tape and reel
SMA5J5.0AHE3/61 ⁽¹⁾	0.064	61	1800	7" diameter plastic tape and reel
SMA5J5.0AHE3/5A ⁽¹⁾	0.064	5A	7500	13" diameter plastic tape and reel

Note

- (1) AEC-Q101 qualified



www.vishay.com

SMA5J5.0A thru SMA5J40CA

Vishay General Semiconductor

RATINGS AND CHARACTERISTICS CURVES (T_A = 25 °C unless otherwise noted)

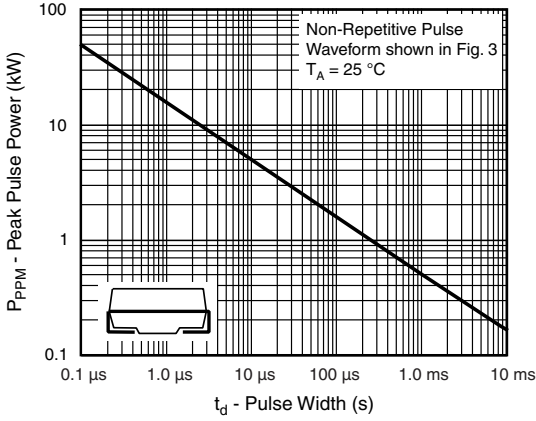

Fig. 1 - Peak Pulse Power Rating Curve

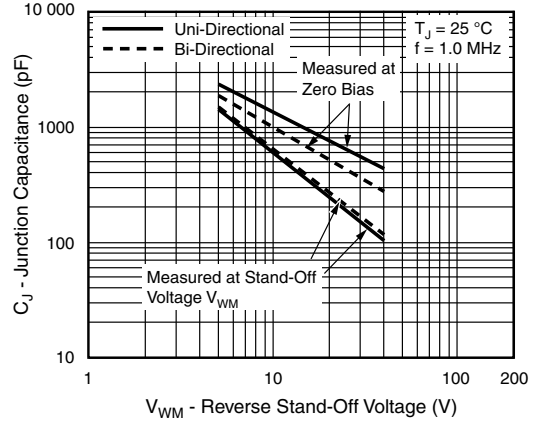

Fig. 4 - Typical Junction Capacitance

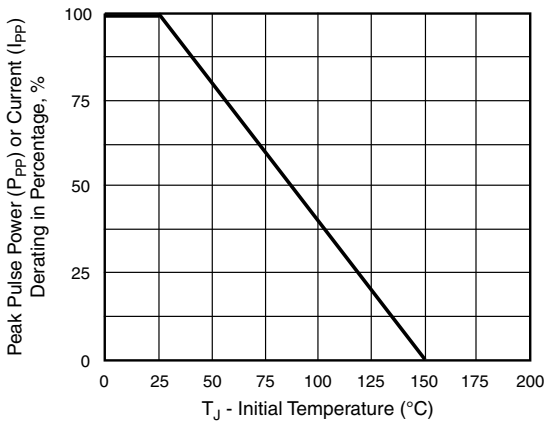

Fig. 2 - Pulse Power or Current vs. Initial Junction Temperature

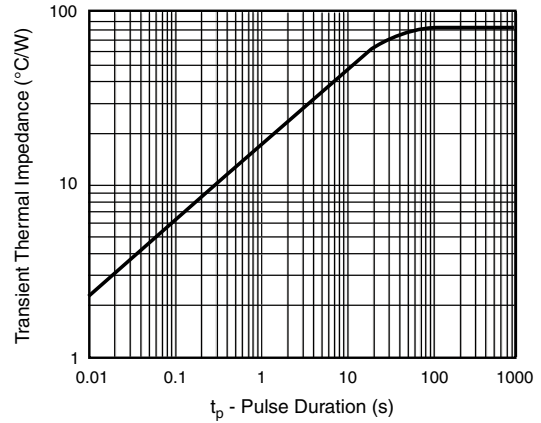

Fig. 5 - Typical Transient Thermal Impedance

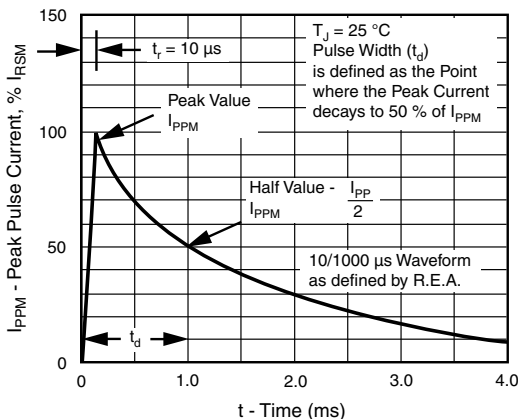

Fig. 3 - Pulse Waveform

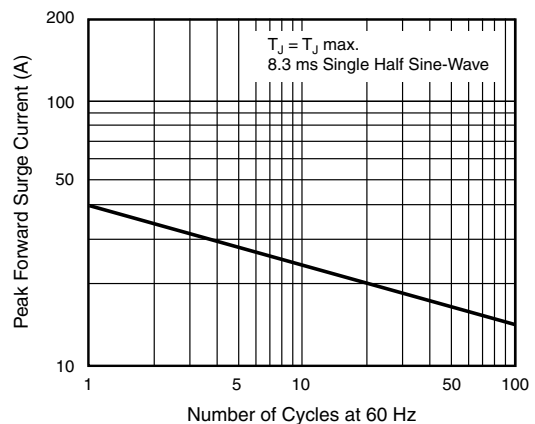

Fig. 6 - Maximum Non-Repetitive Peak Forward Surge Current
Uni-Directional Use Only



www.vishay.com

SMA5J5.0A thru SMA5J40CA

Vishay General Semiconductor

PACKAGE OUTLINE DIMENSIONS in inches (millimeters)

DO-214AC (SMA)

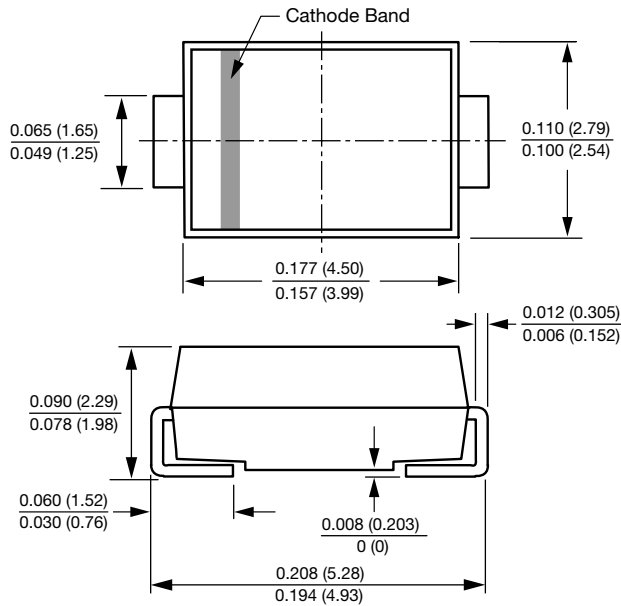

Mounting Pad Layout

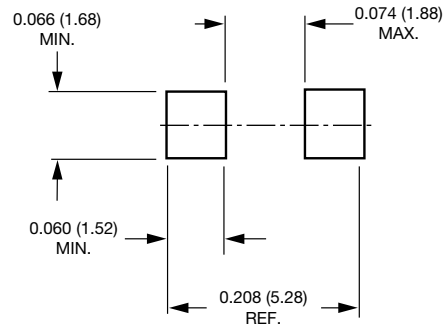



Disclaimer

ALL PRODUCT, PRODUCT SPECIFICATIONS AND DATA ARE SUBJECT TO CHANGE WITHOUT NOTICE TO IMPROVE RELIABILITY, FUNCTION OR DESIGN OR OTHERWISE.

Vishay Intertechnology, Inc., its affiliates, agents, and employees, and all persons acting on its or their behalf (collectively, "Vishay"), disclaim any and all liability for any errors, inaccuracies or incompleteness contained in any datasheet or in any other disclosure relating to any product.

Vishay makes no warranty, representation or guarantee regarding the suitability of the products for any particular purpose or the continuing production of any product. To the maximum extent permitted by applicable law, Vishay disclaims (i) any and all liability arising out of the application or use of any product, (ii) any and all liability, including without limitation special, consequential or incidental damages, and (iii) any and all implied warranties, including warranties of fitness for particular purpose, non-infringement and merchantability.

Statements regarding the suitability of products for certain types of applications are based on Vishay's knowledge of typical requirements that are often placed on Vishay products in generic applications. Such statements are not binding statements about the suitability of products for a particular application. It is the customer's responsibility to validate that a particular product with the properties described in the product specification is suitable for use in a particular application. Parameters provided in datasheets and/or specifications may vary in different applications and performance may vary over time. All operating parameters, including typical parameters, must be validated for each customer application by the customer's technical experts. Product specifications do not expand or otherwise modify Vishay's terms and conditions of purchase, including but not limited to the warranty expressed therein.

Except as expressly indicated in writing, Vishay products are not designed for use in medical, life-saving, or life-sustaining applications or for any other application in which the failure of the Vishay product could result in personal injury or death. Customers using or selling Vishay products not expressly indicated for use in such applications do so at their own risk. Please contact authorized Vishay personnel to obtain written terms and conditions regarding products designed for such applications.

No license, express or implied, by estoppel or otherwise, to any intellectual property rights is granted by this document or by any conduct of Vishay. Product names and markings noted herein may be trademarks of their respective owners.

Material Category Policy

Vishay Intertechnology, Inc. hereby certifies that all its products that are identified as RoHS-Compliant fulfill the definitions and restrictions defined under Directive 2011/65/EU of The European Parliament and of the Council of June 8, 2011 on the restriction of the use of certain hazardous substances in electrical and electronic equipment (EEE) - recast, unless otherwise specified as non-compliant.

Please note that some Vishay documentation may still make reference to RoHS Directive 2002/95/EC. We confirm that all the products identified as being compliant to Directive 2002/95/EC conform to Directive 2011/65/EU.

Vishay Intertechnology, Inc. hereby certifies that all its products that are identified as Halogen-Free follow Halogen-Free requirements as per JEDEC JS709A standards. Please note that some Vishay documentation may still make reference to the IEC 61249-2-21 definition. We confirm that all the products identified as being compliant to IEC 61249-2-21 conform to JEDEC JS709A standards.