

Excellent Integrated System Limited

Stocking Distributor

Click to view price, real time Inventory, Delivery & Lifecycle Information:

[Diodes Incorporated](#)
[AP7215-33YG-13](#)

For any questions, you can email us directly:

sales@integrated-circuit.com



AP7215

600mA CMOS LDO

Features

- Very Low Dropout Voltage
- Low Current Consumption: Typ. 50µA
- Output Voltage: 3.3V
- Guaranteed 600mA Output
- Input Range up to 5.5V
- Current Limit Protection
- Stable with either electrolytic capacitor or low-ESR MLCC (multi-layer ceramic capacitor) Low Temperature Coefficient
- SOP-8L and SOT89-3L: Available in "Green" Molding Compound (No Br, Sb)
- Lead Free Finish / RoHS Compliant (Note 1)

General Description

The AP7215 low-dropout linear regulator operates from a 3.3V to 5.5V supply and delivers a guaranteed 600mA continuous load current.

The high-accuracy output voltage is preset to an internally trimmed voltage. An active-low open-drain reset output remains asserted for at least 20ms (TYP) after input voltage rises above the reset threshold.

The space-saving SOP-8L and SOT89-3L package are suitable for "pocket" and hand-held applications.

Applications

- HD/Blue-Ray DVD & MP3/4 Players
- Mobile Handsets and Smart Phones
- Digital Still Camera
- Hand-Held Computers

Ordering Information

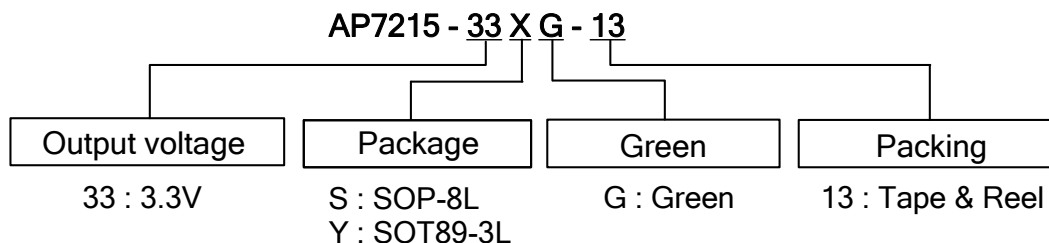

Device	Package Code	Packaging (Note 2)	13" Tape and Reel	
			Quantity	Part Number Suffix
AP7215-33SG-13	S	SOP-8L	2500/Tape & Reel	-13
AP7215-33YG-13	Y	SOT89-3L	2500/Tape & Reel	-13

Notes: 1. EU Directive 2002/95/EC (RoHS). All applicable RoHS exemptions applied, see *EU Directive 2002/95/EC Annex Notes*.
 2. Pad layout as shown on Diodes Inc. suggested pad layout document AP02001, which can be on our website at <http://www.diodes.com/datasheets/ap02001.pdf>.



AP7215
600mA CMOS LDO

Pin Assignments

(1) SOP-8L

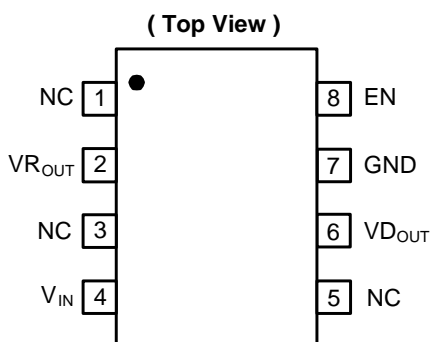

(2) SOT89-3L

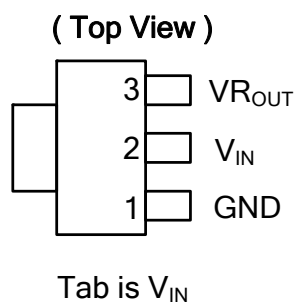

Pin Descriptions

Pin Name	Pin No.		Description
	SOP-8L	SOT89-3L	
NC	1, 3, 5	-	No Connection
VR _{OUT}	2	3	Voltage Output
V _{IN}	4	2	Supply Voltage
VD _{OUT}	6	-	VD Output Voltage (Reset Output)
GND	7	1	Ground
EN	8	-	Enable (VR _{OUT} ON/OFF)



AP7215
600mA CMOS LDO

Block Diagram

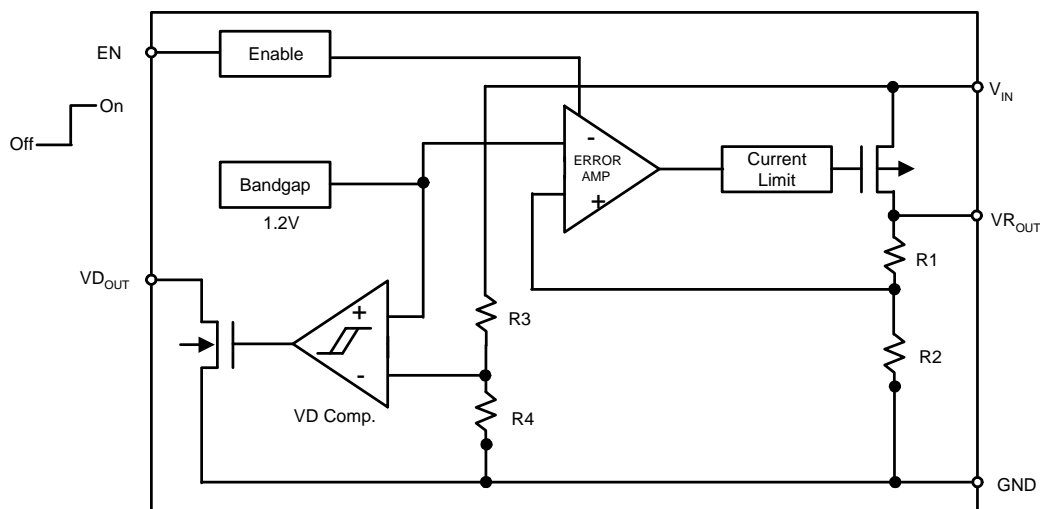

Absolute Maximum Ratings

Symbol	Parameter	Rating	Unit	
ESD HBM	Human Body Model ESD Protection	2	KV	
ESD MM	Machine Model ESD Protection	350	V	
V_{IN}	Input Voltage	+6	V	
$V_{R_{OUT}}$	Output Voltage	$GND - 0.3 \sim V_{IN} + 0.3$	V	
$T_{J(MAX)}$	Maximum Junction Temperature	150	°C	
P_D	Power Dissipation	SOP-8L	1.2	W
		SOT89-3L	0.79	W

Recommended Operating Conditions

Symbol	Parameter	Min	Max	Unit
V_{IN}	Input Voltage	3.3	5.5	V
I_{OUT}	Output Current	0	600	mA
T_J	Operating Junction Temperature Range	-40	125	°C
T_A	Operating Ambient Temperature	-40	85	°C



AP7215

600mA CMOS LDO

Electrical Characteristics

($T_A = 25^\circ\text{C}$, $C_{IN} = 1\mu\text{F}$, $C_{OUT} = 1\mu\text{F}$, $V_{IN} = 5.0\text{V}$, $V_{EN} = V_{IN}$, unless otherwise noted)

Symbol	Parameter	Test Conditions	Min	Typ.	Max	Unit
I_{CCQ}	Quiescent Current	$I_{OUT} = 0\text{mA}$	-	50	80	μA
I_{STBY}	Standby Current	$V_{EN} = \text{GND}$ $V_{IN} = 5.0\text{V}$		15	30	μA
VR_{OUT}	Output Voltage Accuracy	$I_{OUT} = 30\text{mA}$, $V_{IN} = 5\text{V}$	3.234	3.300	3.366	V
$\Delta VR_{OUT}/\Delta T_A/VR_{OUT}$	VR_{OUT} Temperature Coefficient	$T_A = -40^\circ\text{C}$ to 85°C , $I_{OUT} = 30\text{mA}$		± 100		ppm / $^\circ\text{C}$
V_{DO}	Dropout Voltage	$I_{OUT} = 30\text{mA}$		60	100	mV
		$I_{OUT} = 100\text{mA}$		100	250	mV
I_{OUT}	Maximum Output Current	$V_{IN} = 5.3\text{V}$	600			mA
I_{LIMIT}	Current Limit	$V_{IN} = 5.3\text{V}$		750		mA
I_{SHORT}	Short Circuit Current	$V_{IN} = 5.3\text{V}$		50		mA
$\Delta VR_{OUT}/\Delta V_{IN}/VR_{OUT}$	Line Regulation	$4.3\text{V} \leq V_{IN} \leq 5.5\text{V}$, $I_{OUT} = 30\text{mA}$		0.01	± 0.2	%/V
ΔVR_{OUT}	Load Regulation	$1\text{mA} \leq I_{OUT} \leq 100\text{mA}$, $V_{IN} = 5.3\text{V}$		15	50	mV
PSRR	Power Supply Rejection	$V_{IN} = 4.3\text{V} + 0.5\text{Vp-pAC}$, $I_{OUT} = 50\text{mA}$, $F = 1\text{KHz}$		55		dB
V_{EH}	EN Input Threshold	Output ON	1.6			V
V_{EL}		Output OFF			0.25	V
I_{EN}	Enable Pin Current		-0.1		0.1	μA
V_{DF}	V_{IN} Detection Voltage	Detect VD_{OUT} fall	3.83	3.91	3.98	V
V_{HYS}	V_{DF} Hysteresis Range		$V_{DF} \times 1.02$	$V_{DF} \times 1.05$	$V_{DF} \times 1.08$	V
I_{VDOUT}	VD_{OUT} Sink Current	$VD_{OUT} = 0.5\text{V}$, $V_{IN} = 2.0\text{V}$		20		mA
		$VD_{OUT} = 0.5\text{V}$, $V_{IN} = 3.0\text{V}$		30		
t_{RP}	VD_{OUT} Delay Time		10	20	40	ms
θ_{JA}	Thermal Resistance Junction-to-Ambient	SOP-8L (Note 3)		124		$^\circ\text{C}/\text{W}$
		SOT89-3L (Note 3)		173		
θ_{JC}	Thermal Resistance Junction-to-Case	SOP-8L (Note 3)		25		$^\circ\text{C}/\text{W}$
		SOT89-3L (Note 3)		42		

Notes: 3. Test conditions for SOP-8L, SOT89-3L: Device mounted on FR-4 substrate, single sided PC board, 2oz copper, with minimum recommended pad layout.



AP7215
600mA CMOS LDO

Typical Application

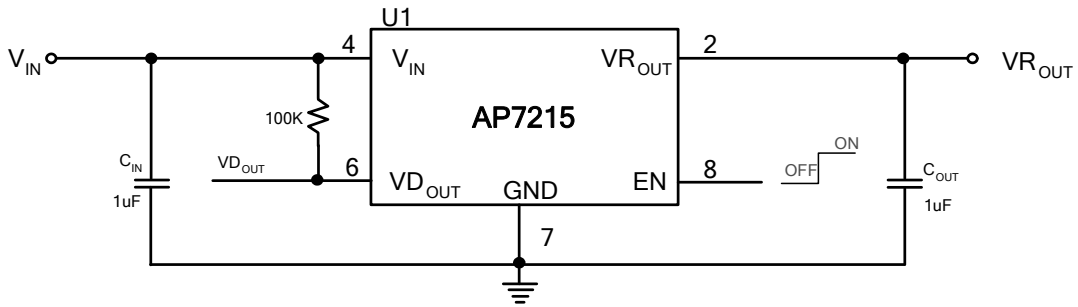

Timing Diagram

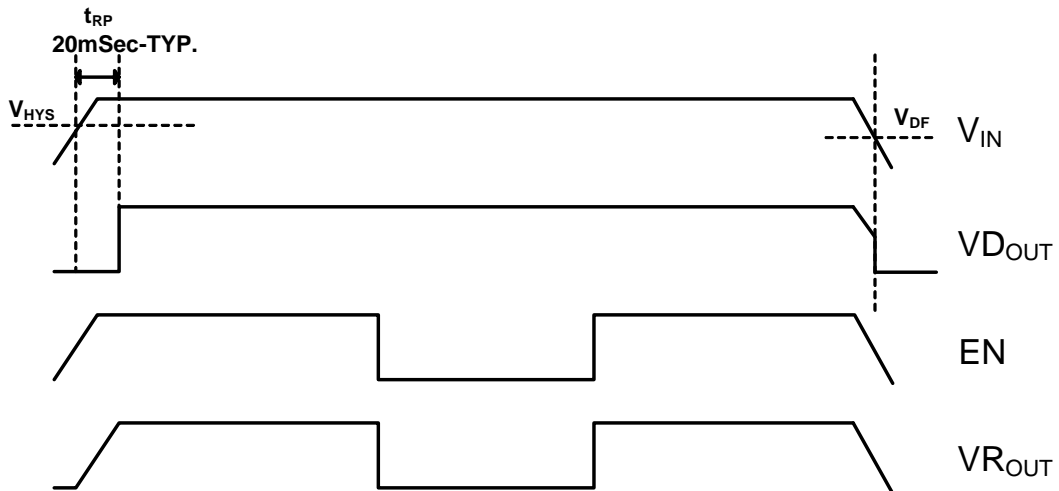



AP7215
600mA CMOS LDO

Typical Performance Characteristics

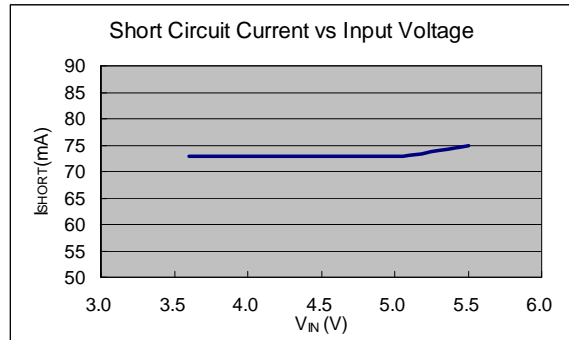
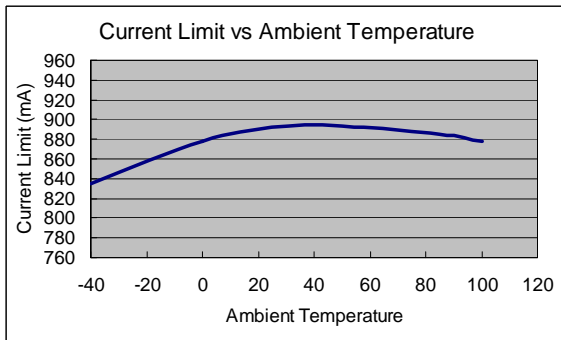
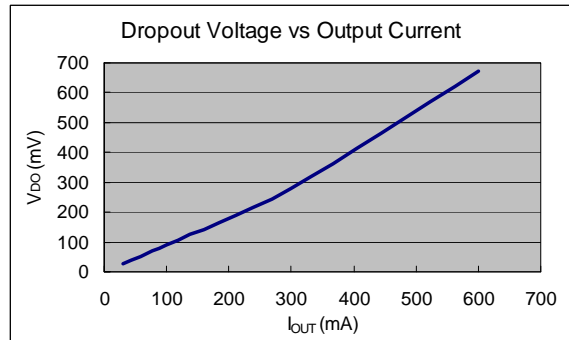
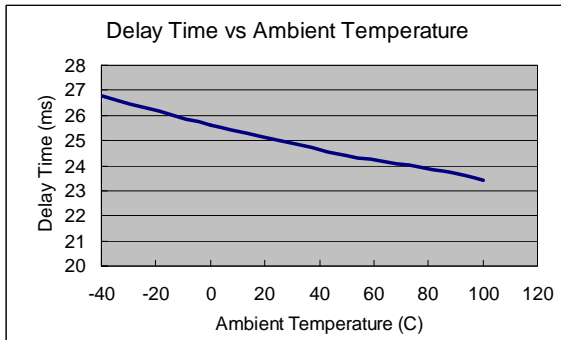
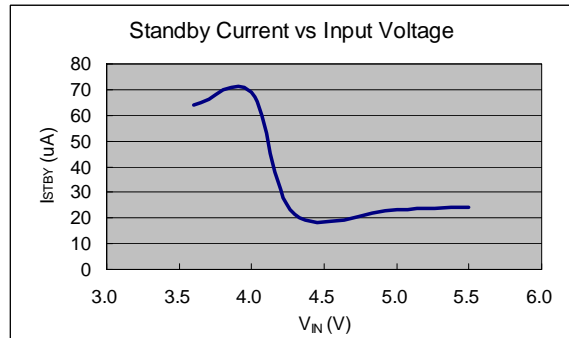
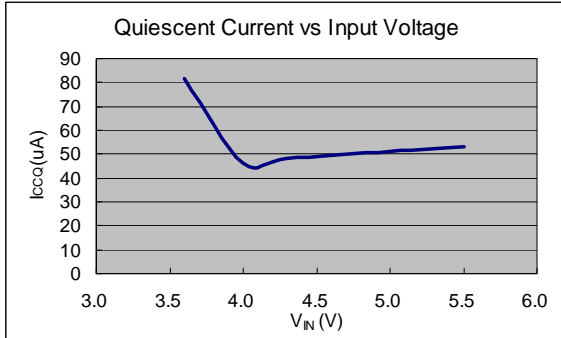



AP7215
600mA CMOS LDO

Typical Performance Characteristics (Continued)

Load Transient Response
($V_{IN}=4.3V$, $I_{OUT}=10mA \sim 300mA$)

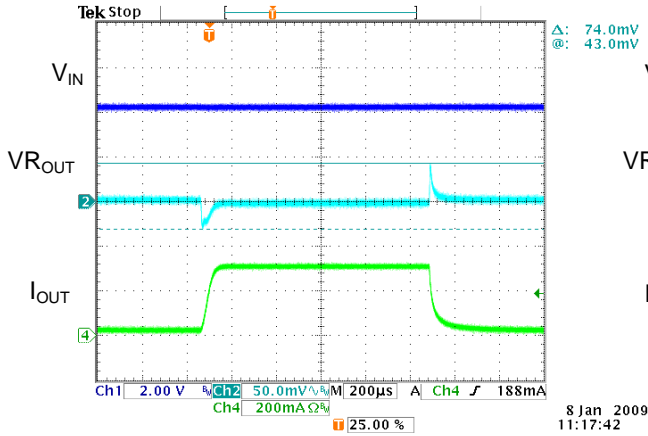

Load Transient Response
($V_{IN}=4.3V$, $I_{OUT}=10mA \sim 600mA$)

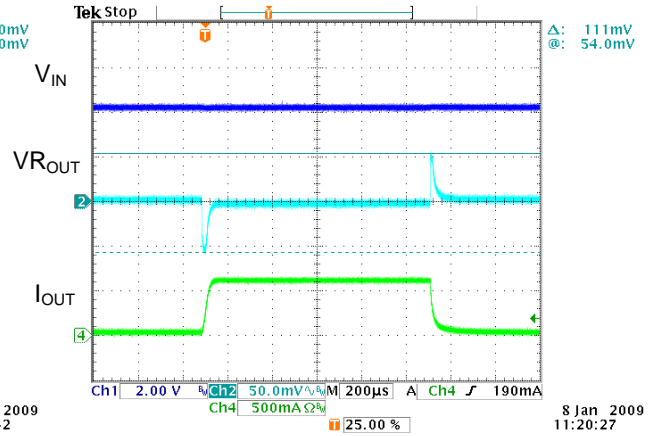

Load Transient Response
($V_{IN}=5.5V$, $I_{OUT}=10mA \sim 300mA$)

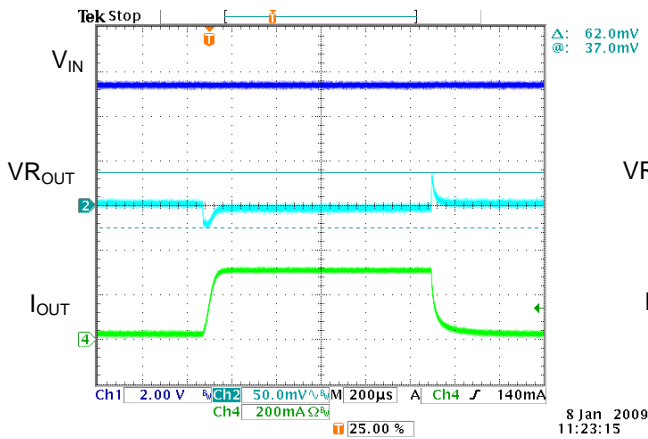

Load Transient Response
($V_{IN}=5.5V$, $I_{OUT}=10mA \sim 600mA$)

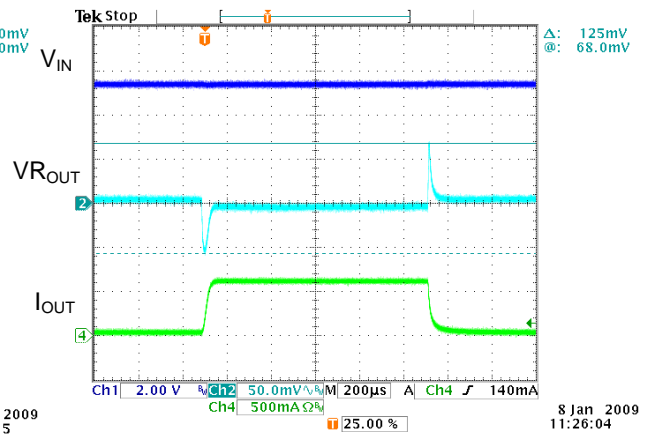



AP7215

600mA CMOS LDO

Application Note

Input Capacitor

A 1 μ F ceramic capacitor is recommended to connect between V_{IN} and GND pins to decouple input power supply glitch and noise. The amount of the capacitance may be increased without limit. A lower ESR (Equivalent Series Resistance) capacitor allows the use of less capacitance, while higher ESR type requires more capacitance. This input capacitor must be placed as close as possible to the device to assure input stability and less noise. For PCB layout, a wide copper trace is required for both V_{IN} and GND.

Suggested Input Capacitance

Vendor	Capacitance	Type	Series
TAIYO YUDEN	1 μ F	Ceramic	LMK212B

Output Capacitor

The output capacitor is required to stabilize and help the transient response of the LDO. The AP7215 is designed to have excellent transient response for most applications with a small amount of output capacitance. The AP7215 is stable with any small ceramic output capacitors of 1.0 μ F or higher value, and the temperature coefficients of X7R or X5R type. Additional capacitance helps to reduce undershoot and overshoot during transient. For PCB layout, the output capacitor must be placed as close as possible to $V_{R_{OUT}}$ and GND pins, and keep the leads as short as possible.

Suggested Output Capacitance

Vendor	Capacitance	Type	Series
TAIYO YUDEN	1 μ F	Ceramic	LMK212B

Suggested Resistance

Vendor	Capacitance	Type
YAGEO	SMD	FR-SK

Region of Stable C_{OUT} ESR vs. Load Current

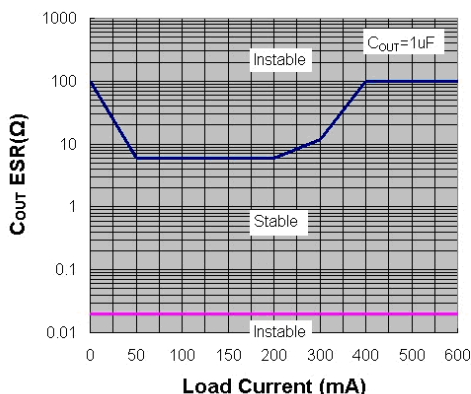

ENABLE/SHUTDOWN Operation

The AP7215 is turned on by setting the EN pin high, and is turned off by pulling it low. If this feature is not used, the EN pin should be tied to V_{IN} pin to keep the regulator output on at all time. To ensure proper operation, the signal source used to drive the EN pin must be able to swing above and below the specified turn-on/off voltage thresholds listed in the Electrical Characteristics section under V_{EH} and V_{EL} .

	$V_{R_{OUT}}$	$V_{D_{OUT}}$
EN=0	0V	ϕ
EN=1	3.3V	ϕ

Current Limit Protection

When output current at $V_{R_{OUT}}$ pin is higher than current limit threshold, the current limit protection will be triggered and clamp the output current to approximately 750mA to prevent over-current and protect the regulator from damage due to overheating.

Short circuit protection

When $V_{R_{OUT}}$ pin is shorted to GND or $V_{R_{OUT}}$ voltage is less than 200mV, short circuit protection will be triggered and clamp the output current to approximately 50mA.

$V_{D_{OUT}}$ (reset output)

---Open-Drain Active-Low reset output---

In general, $V_{D_{OUT}}$ is pulled up by a resistor (100K Ω) to V_{IN} . The AP7215 microprocessor (μ P) supervisory circuitry asserts a guaranteed logic-low reset during power-up and power-down. Reset is asserted when V_{IN} is below the reset threshold and remain asserted for at least t_{RP} after V_{IN} rises above the reset threshold.

As long as V_{IN} is lower than the reset threshold, $V_{D_{OUT}}$ remains at logic "0". When V_{IN} becomes higher than V_{HYS} , a logic "1" is asserted after a 20ms time delay defined by t_{RP} .



AP7215
600mA CMOS LDO

Marking Information

(1) SOP-8L

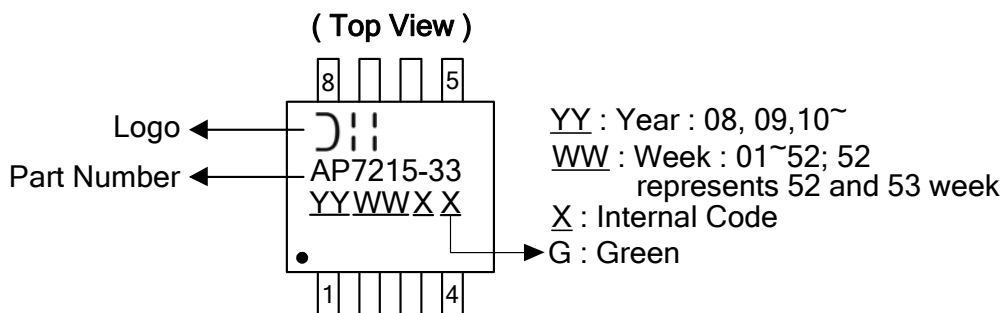

(2) SOT89-3L

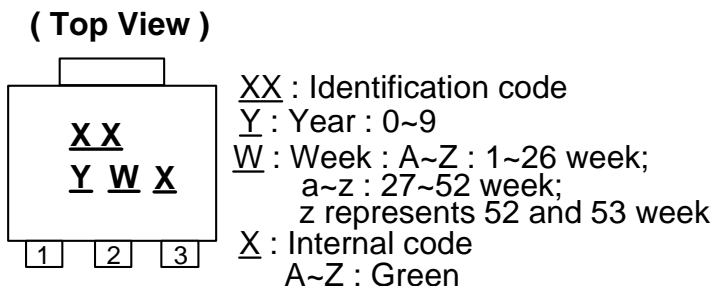

Device	Package type	Identification Code
AP7215Y	SOT89-3L	N8

Package Information (All Dimensions in mm)

(1) Package Type: SOP-8L

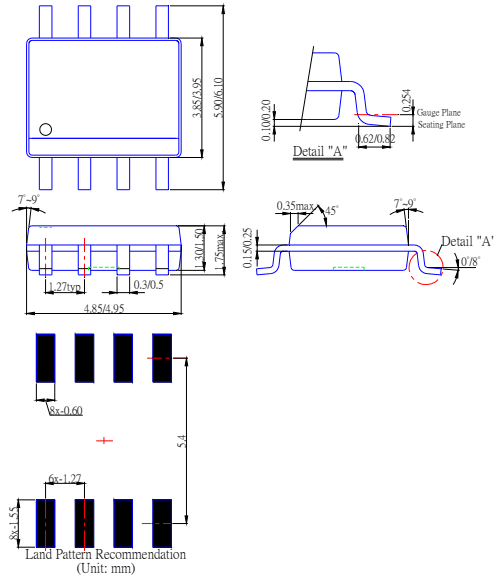

(2) Package Type: SOT89-3L

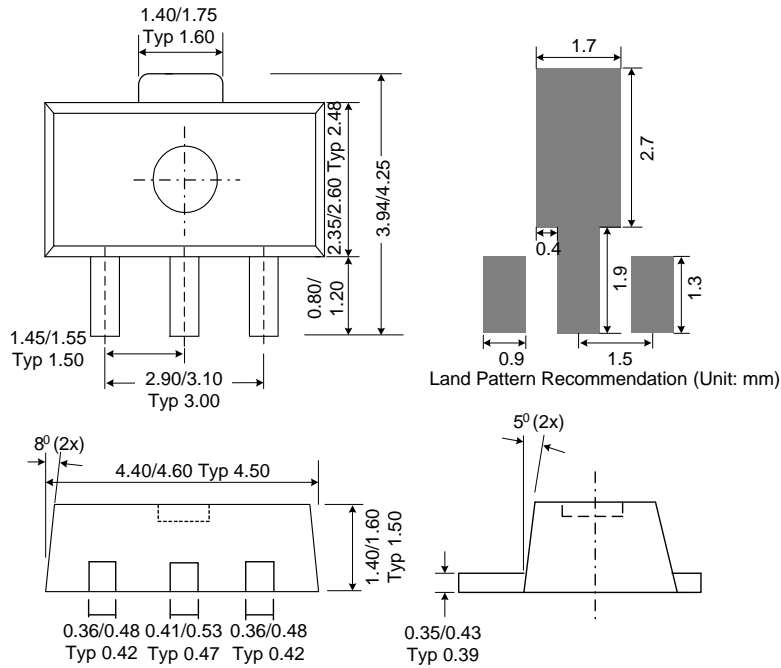



AP7215
600mA CMOS LDO

IMPORTANT NOTICE

Diodes Incorporated and its subsidiaries reserve the right to make modifications, enhancements, improvements, corrections or other changes without further notice to any product herein. Diodes Incorporated does not assume any liability arising out of the application or use of any product described herein; neither does it convey any license under its patent rights, nor the rights of others. The user of products in such applications shall assume all risks of such use and will agree to hold Diodes Incorporated and all the companies whose products are represented on our website, harmless against all damages.

LIFE SUPPORT

Diodes Incorporated products are not authorized for use as critical components in life support devices or systems without the expressed written approval of the President of Diodes Incorporated.