

## Excellent Integrated System Limited

Stocking Distributor

Click to view price, real time Inventory, Delivery & Lifecycle Information:

[Bel Fuse Inc.](#)  
[SI-60092-F](#)

For any questions, you can email us directly:  
[sales@integrated-circuit.com](mailto:sales@integrated-circuit.com)

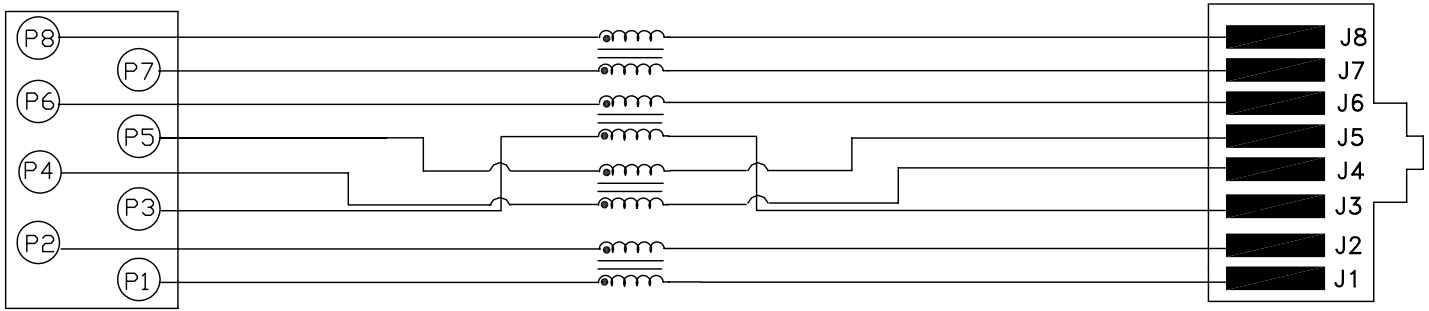

**ELECTRICAL SPECIFICATIONS:**

1.0 INDUCTANCE: (P1-J1) : (P3-J3) : ( P4-J4) : (P7-J7) : 65 uH TYP @.05V, 10KHz

2.0 DC RESISTANCE: P8-J8 = P7-J7 : .5 OHM MAX  
 P6-J6 = P3-J3 : .5 OHM MAX  
 P5-J5 = P4-J4 : .5 OHM MAX  
 P2-J2 = P1-J1 : .5 OHM MAX



3.0 COMMON MODE:

FREQUENCY (MHz)	CMA (-dB)	
	TYPICAL	MIN
1	8	5
5	17	15
20	23	15
70	25	20
200	22	17
500	11	6

Bel Stewart Connector 11118 Susquehanna Trail, South Glen Rock, Pa 17327-9199 717.234.7512 <a href="http://www.stewartconnector.com">http://www.stewartconnector.com</a>		
SHEET 1 OF 2	DRAWING NO. SI-60092-F	

THIS DRAWING AND THE SUBJECT MATTER SHOWN THEREON ARE CONFIDENTIAL AND PROPERTY OF BEL STEWART CONNECTOR AND SHALL NOT BE REPRODUCED, COPIED, OR USED IN ANY MANNER WITHOUT PRIOR WRITTEN CONTENT OF BEL STEWART CONNECTOR. THE SUBJECT MATTER MAY BE PATENTED OR A PATENT MAY BE PENDING.

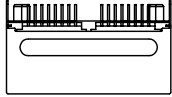
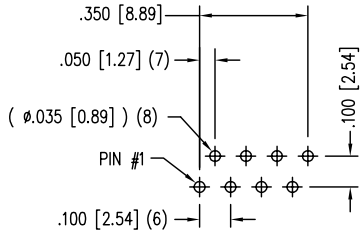

DETAIL "A"  
TYPICAL HOLE LAYOUT  
2 PLACES

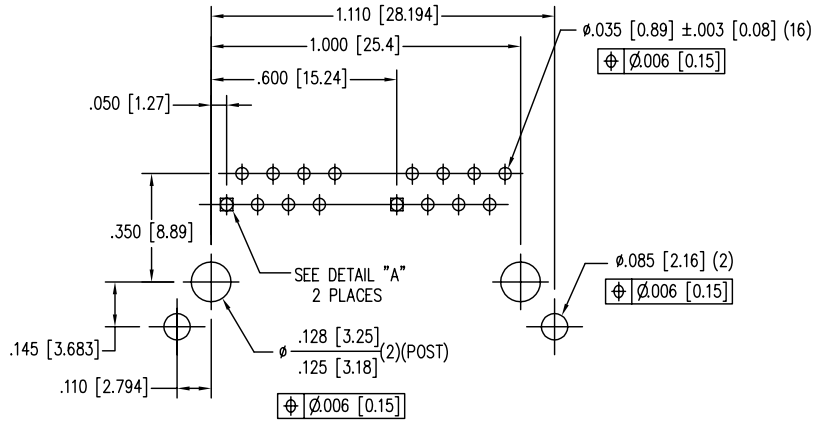
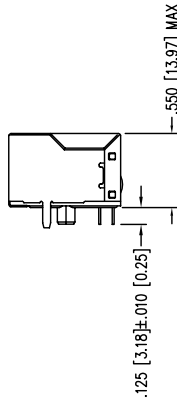
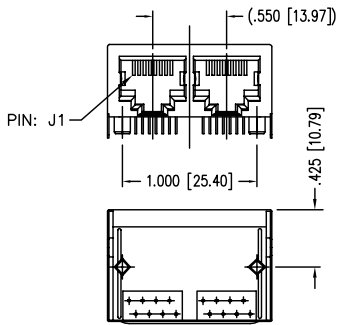
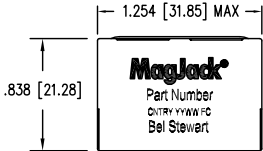

P.C.B. RECOMMENDED HOLE LAYOUT  
SEEN FROM COMPONENT SIDE

ALL CENTERLINE DIMENSIONS ARE BASIC.



NOTES:

1. CONNECTOR MATERIALS:  
HOUSING: THERMOPLASTIC UL94 V-0  
CONTACT/SHIELD: COPPER ALLOY  
SHIELD PLATING: NICKEL OR TIN  
CONTACT PLATING: SELECTIVE GOLD,  
50 MICRO-INCHES MIN. IN CONTACT AREA.
2. PIN NOT ELECTRICALLY CONNECTED MAYBE OMITTED.  
SEE ELECTRICAL DRAWING FOR OMITTED PINS.
3. TOLERANCES COMPLY WITH F.C.C. DIMENSION REQUIREMENTS.
4. ALL TOLERANCES NOT OTHERWISE SPECIFIED TO BE ±.005 [0.13]
5. WAVE SOLDER COMPATIBLE - PREHEAT 125°C/90SECS.

Bel Stewart Connector  
11118 Susquehanna Trail, South  
Glen Rock, Pa 17327-9199  
717.234.7512

**MagJack**  
http://www.stewartconnector.com

THIS DRAWING AND THE SUBJECT MATTER SHOWN THEREON ARE CONFIDENTIAL AND PROPERTY OF BEL STEWART CONNECTOR AND SHALL NOT BE REPRODUCED, COPIED, OR USED IN ANY MANNER WITHOUT PRIOR WRITTEN CONTENT OF BEL STEWART CONNECTOR. THE SUBJECT MATTER MAY BE PATENTED OR A PATENT MAY BE PENDING.

SHEET 2 OF 2	DRAWING NO. SI-60092-F	REV. 07
-----------------	---------------------------	------------