

## **Excellent Integrated System Limited**

Stocking Distributor

Click to view price, real time Inventory, Delivery & Lifecycle Information:

[Infineon Technologies](#)

[IHW30N100T](#)

For any questions, you can email us directly:

[sales@integrated-circuit.com](mailto:sales@integrated-circuit.com)



# IHW30N100T

## Soft Switching Series

Low Loss DuoPack : IGBT in TrenchStop® and Fieldstop technology with anti-parallel diode

**Features:**

- 1.1V Forward voltage of antiparallel rectifier diode
- Specified for  $T_{jmax} = 175^{\circ}\text{C}$
- TrenchStop® and Fieldstop technology for 1000 V applications offers :
  - very tight parameter distribution
  - high ruggedness, temperature stable behavior
  - easy parallel switching capability due to positive temperature coefficient in  $V_{CE(sat)}$
- Low EMI
- Qualified according to JEDEC<sup>1</sup> for target applications
- Application specific optimisation of inverse diode
- Pb-free lead plating; RoHS compliant

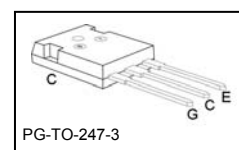
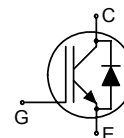

**Applications:**

- Microwave Oven
- Soft Switching Applications

Type	$V_{CE}$	$I_C$	$V_{CE(sat), T_j=25^{\circ}\text{C}}$	$T_{j,max}$	Marking	Package
IHW30N100T	1000V	30A	1.55V	175°C	H30T100	PG-TO-247-3

**Maximum Ratings**

Parameter	Symbol	Value	Unit
Collector-emitter voltage	$V_{CE}$	1000	V
DC collector current	$I_C$		A
$T_C = 25^{\circ}\text{C}$		60	
$T_C = 100^{\circ}\text{C}$		30	
Pulsed collector current, $t_p$ limited by $T_{jmax}$	$I_{Cpuls}$	90	
Turn off safe operating area $V_{CE} \leq 1000\text{V}$ , $T_j \leq 175^{\circ}\text{C}$	-	90	
Diode forward current	$I_F$		
$T_C = 25^{\circ}\text{C}$		22	
$T_C = 100^{\circ}\text{C}$		12	
Diode pulsed current, $t_p$ limited by $T_{jmax}$	$I_{Fpuls}$	36	
Gate-emitter voltage	$V_{GE}$	$\pm 20$	V
Transient Gate-emitter voltage ( $t_p < 5 \text{ ms}$ )		$\pm 25$	
Power dissipation, $T_C = 25^{\circ}\text{C}$	$P_{tot}$	412	W
Operating junction temperature	$T_j$	-40...+175	°C
Storage temperature	$T_{stg}$	-55...+175	°C
Soldering temperature, 1.6mm (0.063 in.) from case for 10s	-	260	

<sup>1</sup> J-STD-020 and JESD-022



# IHW30N100T

## Soft Switching Series

### Thermal Resistance

Parameter	Symbol	Conditions	Max. Value	Unit
<b>Characteristic</b>				
IGBT thermal resistance, junction – case	$R_{thJC}$		0.36	K/W
Diode thermal resistance, junction – case	$R_{thJCD}$		1.1	
Thermal resistance, junction – ambient	$R_{thJA}$		40	

### Electrical Characteristic, at $T_j = 25^\circ\text{C}$ , unless otherwise specified

Parameter	Symbol	Conditions	Value			Unit
			min.	Typ.	max.	
<b>Static Characteristic</b>						
Collector-emitter breakdown voltage	$V_{(BR)CES}$	$V_{GE}=0V, I_C=500\mu A$	1000	-	-	V
Collector-emitter saturation voltage	$V_{CE(sat)}$	$V_{GE} = 15V, I_C=30A$	1.3	1.55	1.7	
		$T_j=25^\circ\text{C}$	-	1.7	-	
		$T_j=175^\circ\text{C}$	-	1.8	-	
Diode forward voltage	$V_F$	$V_{GE}=0V, I_F=10A$	-	1.1	1.3	
		$T_j=25^\circ\text{C}$	-	1.0	-	
		$T_j=175^\circ\text{C}$	-	1.0	-	
Gate-emitter threshold voltage	$V_{GE(th)}$	$I_C=700\mu A, V_{CE}=V_{GE}$	5.1	5.8	6.4	
Zero gate voltage collector current	$I_{CES}$	$V_{CE}=1000V, V_{GE}=0V$	-	-	5	$\mu A$
		$T_j=25^\circ\text{C}$	-	-	2500	
		$T_j=175^\circ\text{C}$	-	-	-	
Gate-emitter leakage current	$I_{GES}$	$V_{CE}=0V, V_{GE}=20V$	-	-	600	nA
Transconductance	$g_{fs}$	$V_{CE}=20V, I_C=30A$	-	28	-	S

### Dynamic Characteristic

Input capacitance	$C_{iss}$	$V_{CE}=25V, V_{GE}=0V, f=1MHz$	-	3573	-	pF
Output capacitance	$C_{oss}$		-	98	-	
Reverse transfer capacitance	$C_{rss}$		-	76	-	
Gate charge	$Q_{Gate}$	$V_{CC}=800V, I_C=30A, V_{GE}=15V$	-	217	-	nC
Internal emitter inductance measured 5mm (0.197 in.) from case	$L_E$		-	13	-	nH



# IHW30N100T

## Soft Switching Series

### Switching Characteristic, Inductive Load, at $T_j=25^\circ\text{C}$

Parameter	Symbol	Conditions	Value			Unit
			min.	Typ.	max.	
<b>IGBT Characteristic</b>						
Turn-on delay time	$t_{d(on)}$	$T_j=25^\circ\text{C}$ , $V_{CC}=600\text{V}$ , $I_C=30\text{A}$ , $V_{GE}=0/15\text{V}$ , $R_G=15\Omega$ ,	-	35	-	ns
Rise time	$t_r$		-	22	-	
Turn-off delay time	$t_{d(off)}$		-	546	-	
Fall time	$t_f$		-	27	42	
Turn-on energy	$E_{on}$	Energy losses include "tail" and diode reverse recovery.	-	-	-	mJ
Turn-off energy	$E_{off}$		-	1.6	2.6	
Total switching energy	$E_{ts}$		-	-	-	

### Switching Characteristic, Inductive Load, at $T_j=175^\circ\text{C}$

Parameter	Symbol	Conditions	Value			Unit
			min.	Typ.	max.	
<b>IGBT Characteristic</b>						
Turn-on delay time	$t_{d(on)}$	$T_j=175^\circ\text{C}$ $V_{CC}=600\text{V}$ , $I_C=30\text{A}$ , $V_{GE}=0/15\text{V}$ , $R_G=15\Omega$	-	33	-	ns
Rise time	$t_r$		-	36	-	
Turn-off delay time	$t_{d(off)}$		-	623	-	
Fall time	$t_f$		-	37	70	
Turn-on energy	$E_{on}$	Energy losses include "tail" and diode reverse recovery.	-	-	-	mJ
Turn-off energy	$E_{off}$		-	2.3	4	
Total switching energy	$E_{ts}$		-	-	-	



# IHW30N100T

## Soft Switching Series

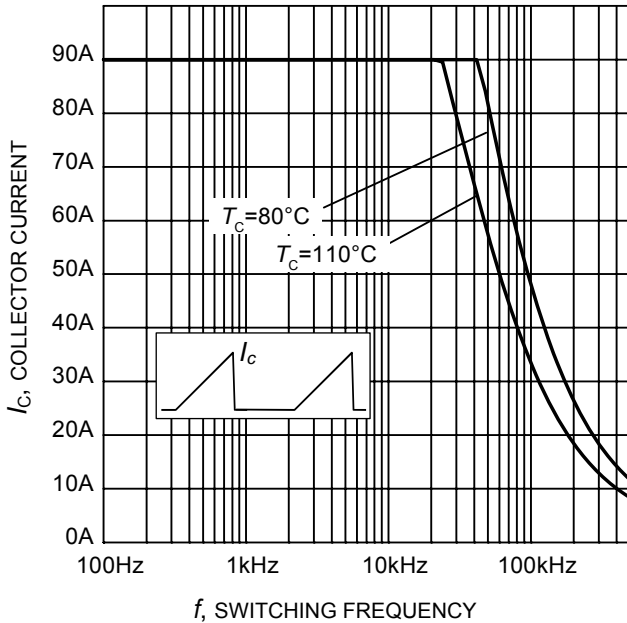

**Figure 1. Collector current as a function of switching frequency for triangular current ( $E_{on} = 0$ , hard turn-off)**  
 ( $T_j \leq 175^\circ\text{C}$ ,  $D = 0.5$ ,  $V_{CE} = 400\text{V}$ ,  $V_{GE} = 0/+15\text{V}$ ,  $R_G = 26.9\Omega$ )

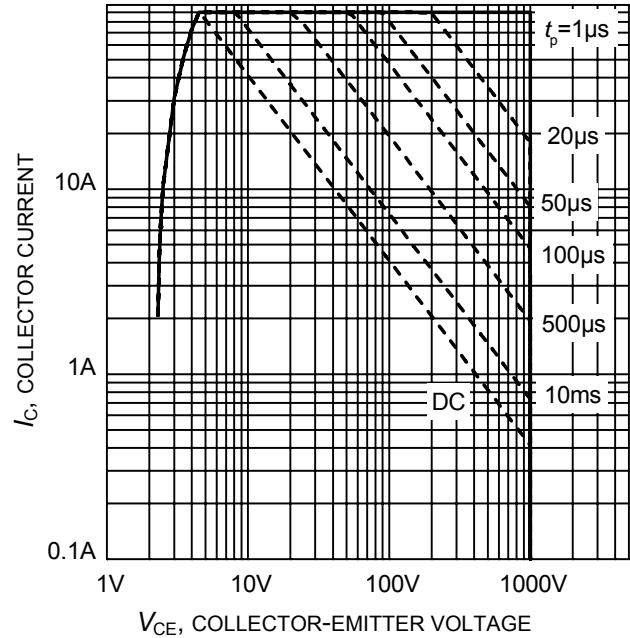

**Figure 2. Safe operating area**  
 ( $D = 0$ ,  $T_C = 25^\circ\text{C}$ ,  $T_j \leq 175^\circ\text{C}$ ;  
 $V_{GE} = 15\text{V}$ )

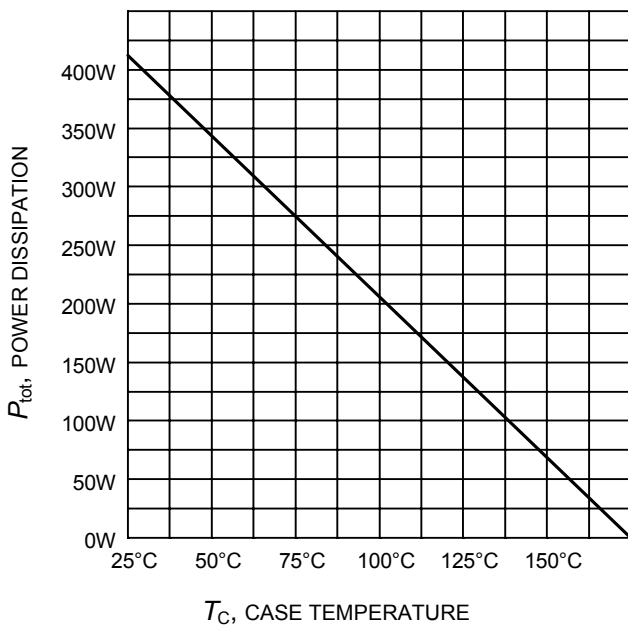

**Figure 3. Power dissipation as a function of case temperature**  
 ( $T_j \leq 175^\circ\text{C}$ )

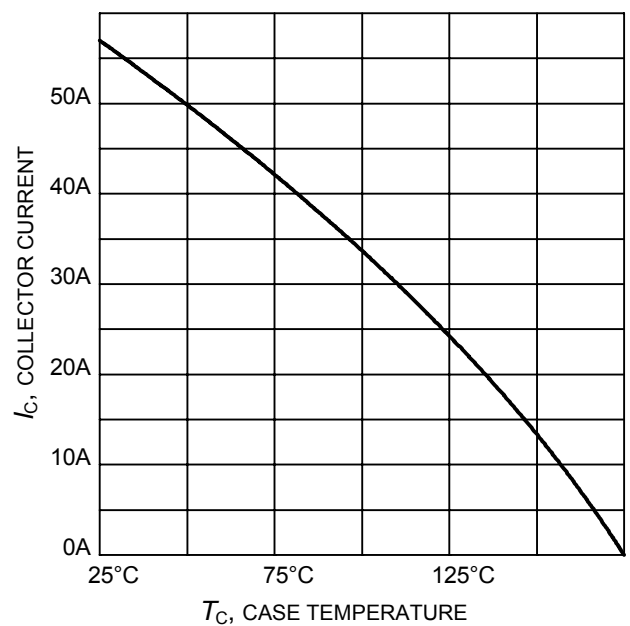
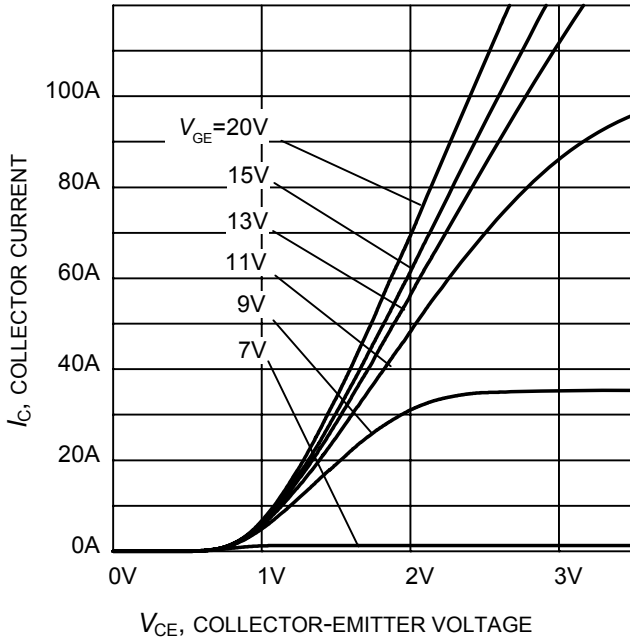

**Figure 4. Collector current as a function of case temperature**  
 ( $V_{GE} \geq 15\text{V}$ ,  $T_j \leq 175^\circ\text{C}$ )



# IHW30N100T

## Soft Switching Series



**Figure 5. Typical output characteristic**  
( $T_j = 25^\circ\text{C}$ )

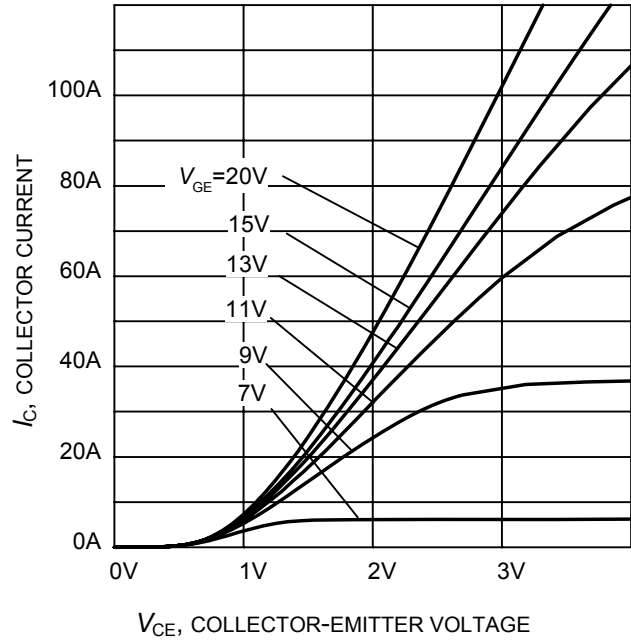

**Figure 6. Typical output characteristic**  
( $T_j = 175^\circ\text{C}$ )

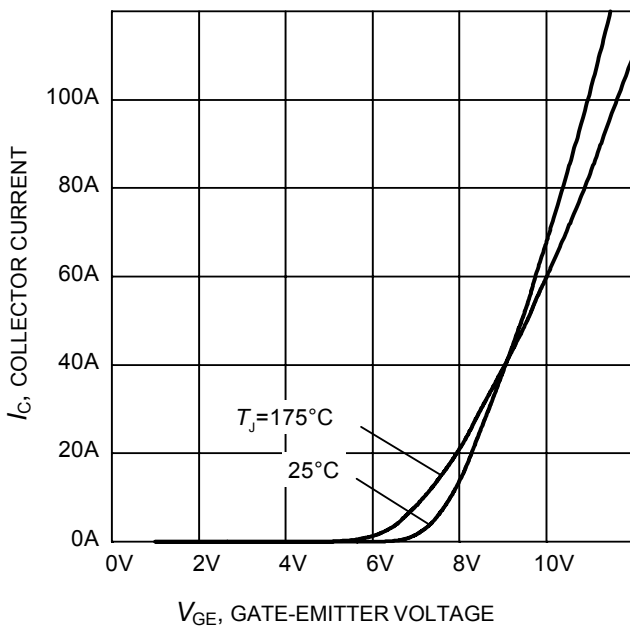

**Figure 7. Typical transfer characteristic**  
( $V_{ce} = 20\text{V}$ )

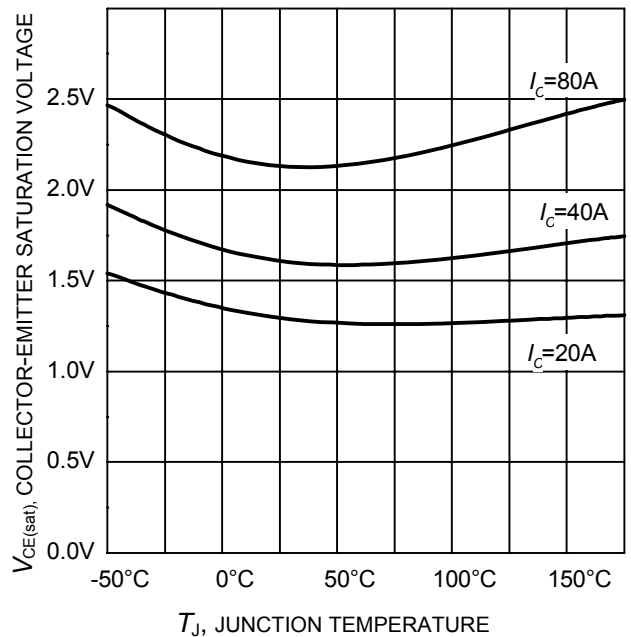
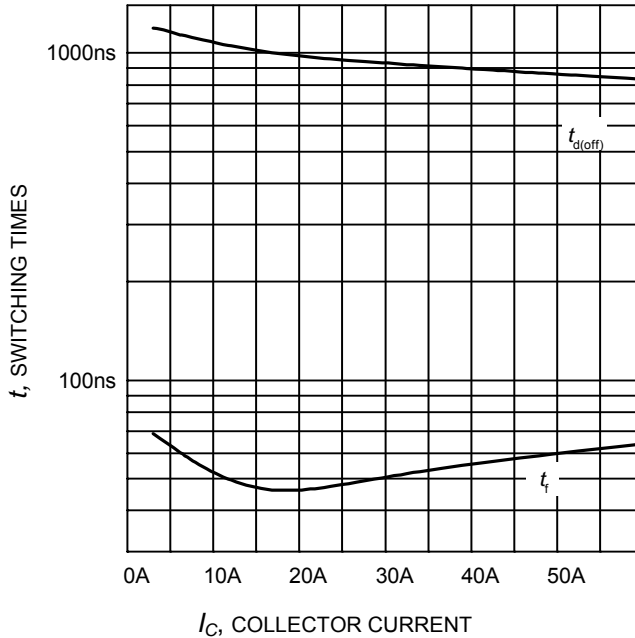

**Figure 8. Typical collector-emitter saturation voltage as a function of junction temperature**  
( $V_{ge} = 15\text{V}$ )



# IHW30N100T

## Soft Switching Series



**Figure 9. Typical switching times as a function of collector current** (inductive load,  $T_J=175^\circ\text{C}$ ,  $V_{CE} = 600\text{V}$ ,  $V_{GE} = 0/15\text{V}$ ,  $R_G=26.9\Omega$ , Dynamic test circuit in Figure E)

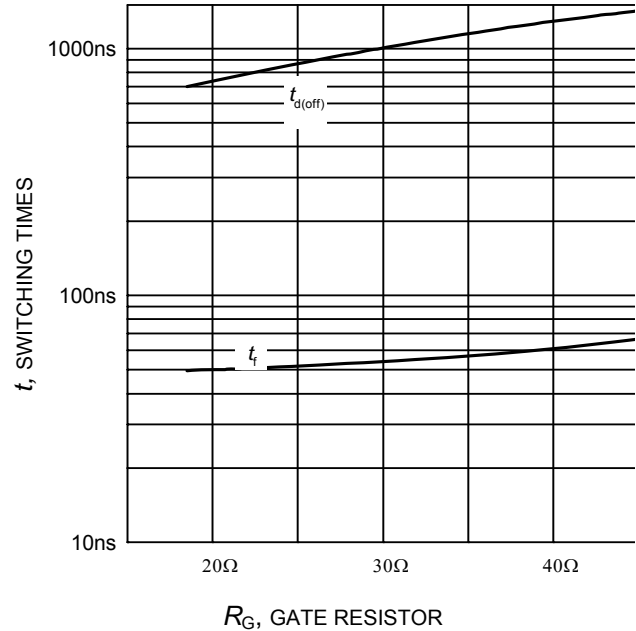

**Figure 10. Typical switching times as a function of gate resistor** (inductive load,  $T_J = 175^\circ\text{C}$ ,  $V_{CE} = 600\text{V}$ ,  $V_{GE} = 0/15\text{V}$ ,  $I_C = 30\text{A}$ , Dynamic test circuit in Figure E)

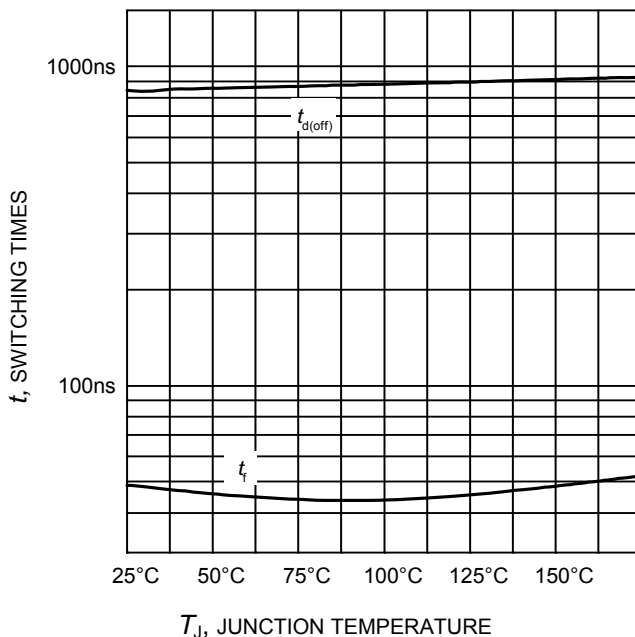

**Figure 11. Typical switching times as a function of junction temperature** (inductive load,  $V_{CE} = 600\text{V}$ ,  $V_{GE} = 0/15\text{V}$ ,  $I_C = 30\text{A}$ ,  $R_G=26.9\Omega$ , Dynamic test circuit in Figure E)

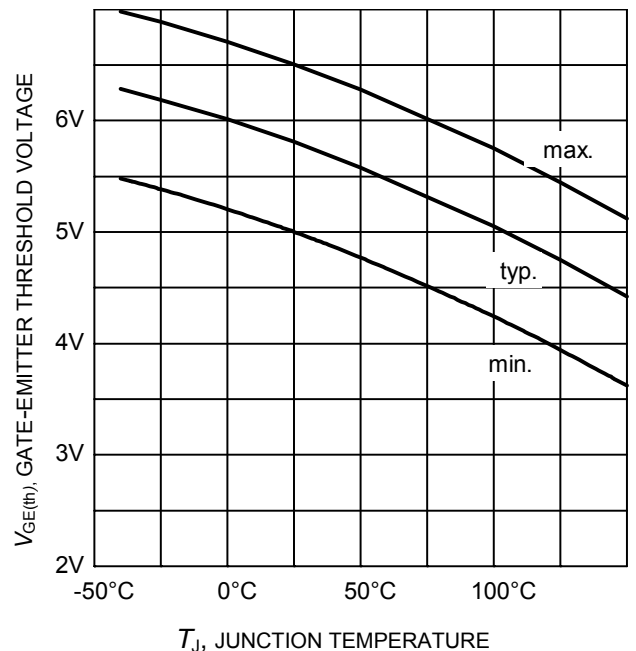
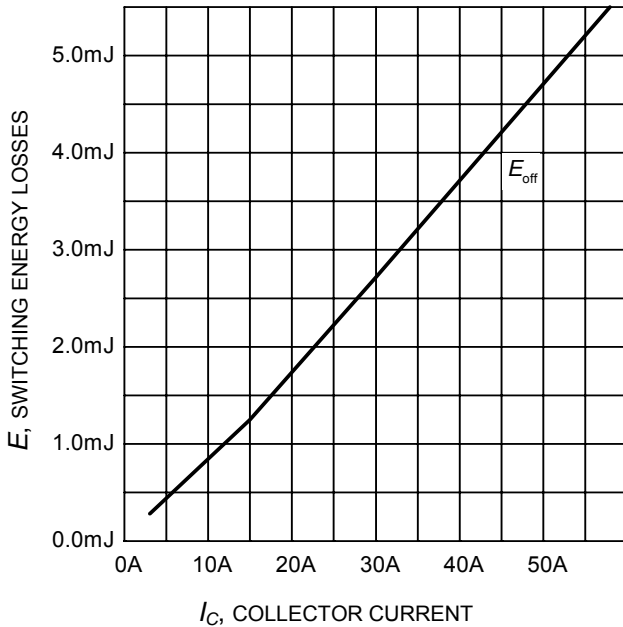

**Figure 12. Gate-emitter threshold voltage as a function of junction temperature** ( $I_C = 0.7\text{mA}$ )



# IHW30N100T

## Soft Switching Series



**Figure 13. Typical switching energy losses as a function of collector current** (inductive load,  $T_J = 175^\circ\text{C}$ ,  $V_{CE} = 600\text{V}$ ,  $V_{GE} = 0/15\text{V}$ ,  $R_G = 26.9\Omega$ , Dynamic test circuit in Figure E)

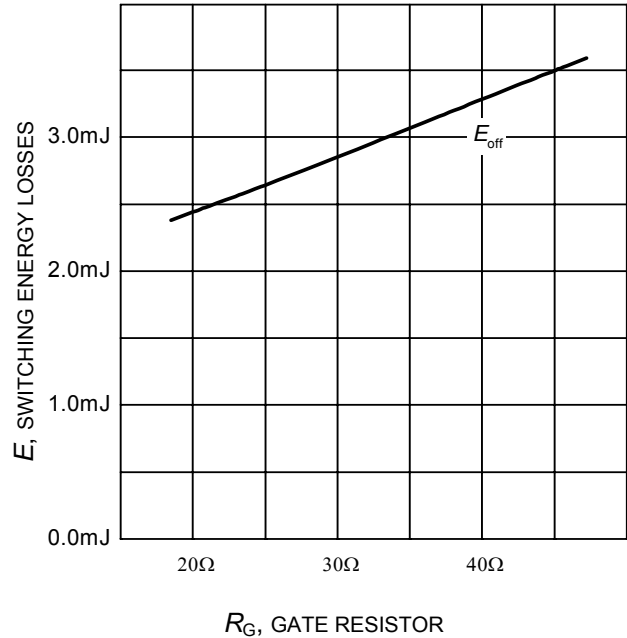

**Figure 14. Typical switching energy losses as a function of gate resistor** (inductive load,  $T_J = 175^\circ\text{C}$ ,  $V_{CE} = 600\text{V}$ ,  $V_{GE} = 0/15\text{V}$ ,  $I_C = 30\text{A}$ , Dynamic test circuit in Figure E)

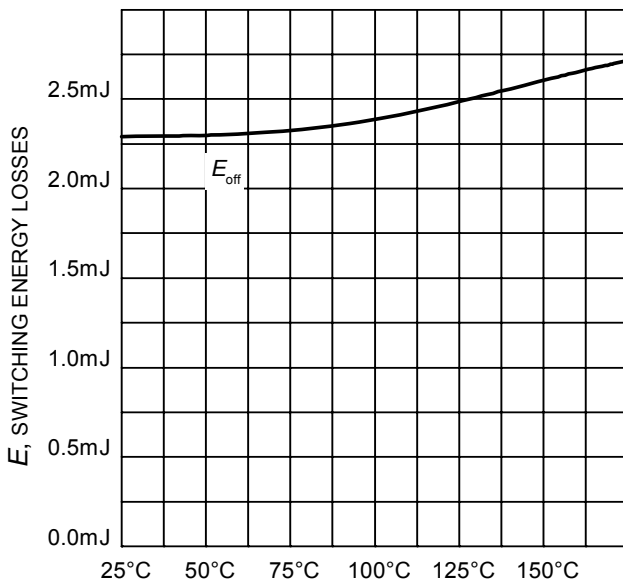

**Figure 15. Typical switching energy losses as a function of junction temperature** (inductive load,  $V_{CE} = 600\text{V}$ ,  $V_{GE} = 0/15\text{V}$ ,  $I_C = 30\text{A}$ ,  $R_G = 26.9\Omega$ , Dynamic test circuit in Figure E)

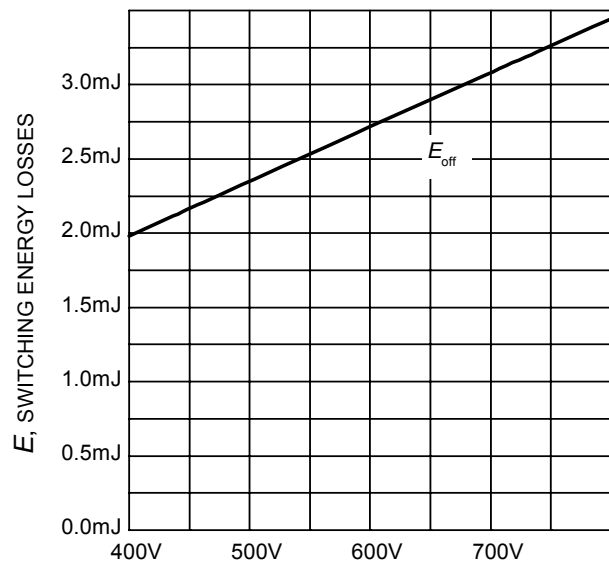

**Figure 16. Typical switching energy losses as a function of collector emitter voltage** (inductive load,  $T_J = 175^\circ\text{C}$ ,  $V_{GE} = 0/15\text{V}$ ,  $I_C = 30\text{A}$ ,  $R_G = 26.9\Omega$ , Dynamic test circuit in Figure E)





# IHW30N100T

## Soft Switching Series

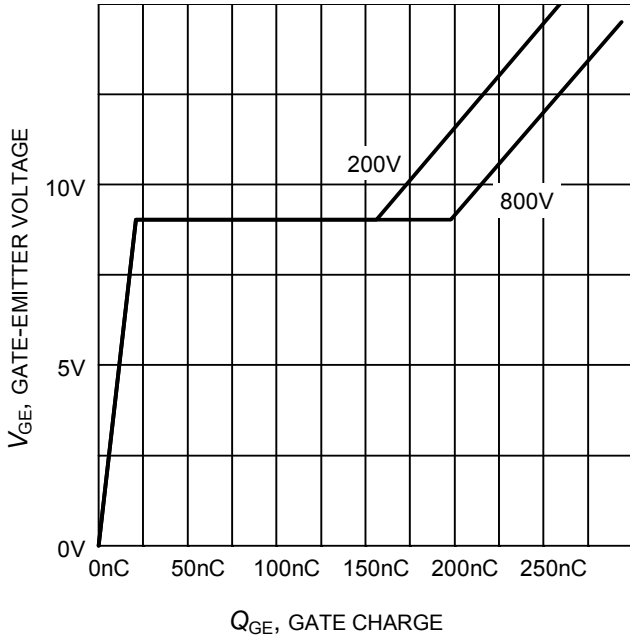

**Figure 17. Typical gate charge**  
( $I_C=30$  A)

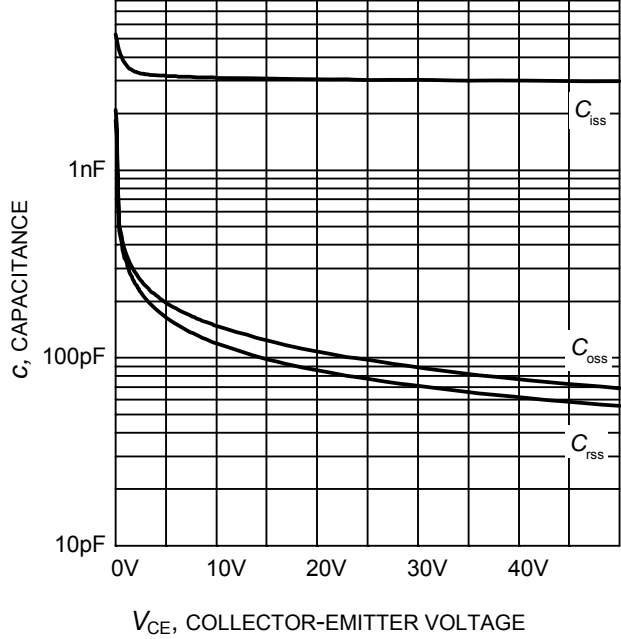

**Figure 18. Typical capacitance as a function of collector-emitter voltage**  
( $V_{GE}=0V, f = 1$  MHz)

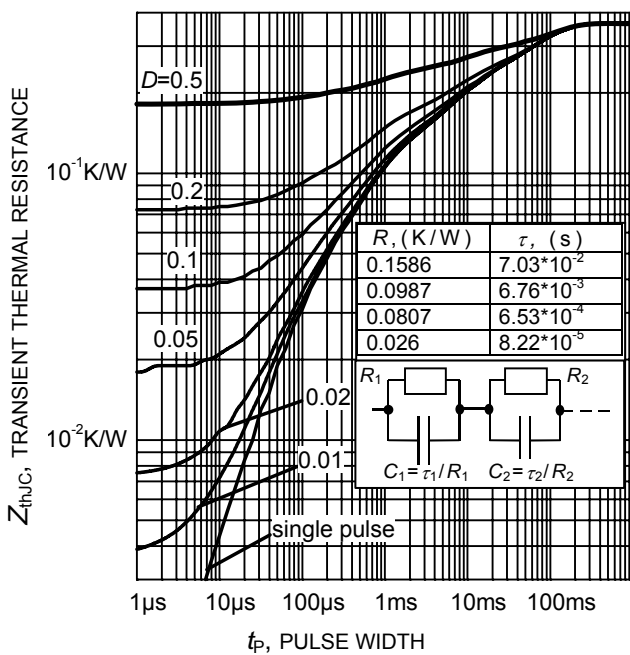

**Figure 19. IGBT transient thermal resistance**  
( $D = t_p / T$ )

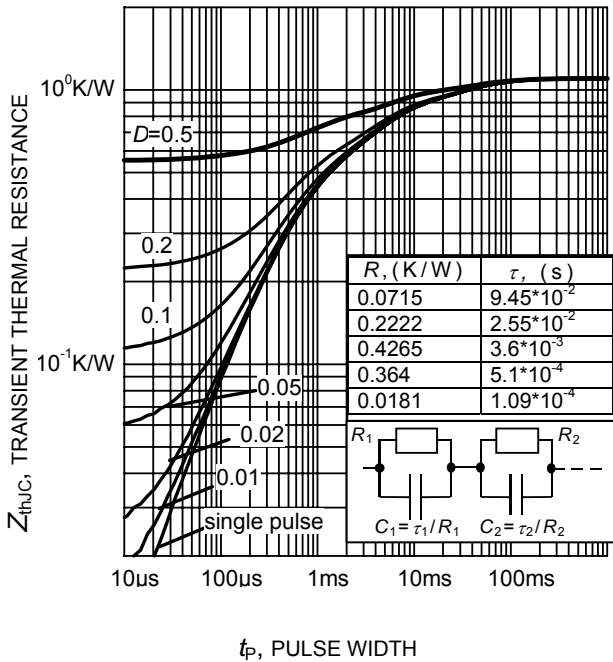
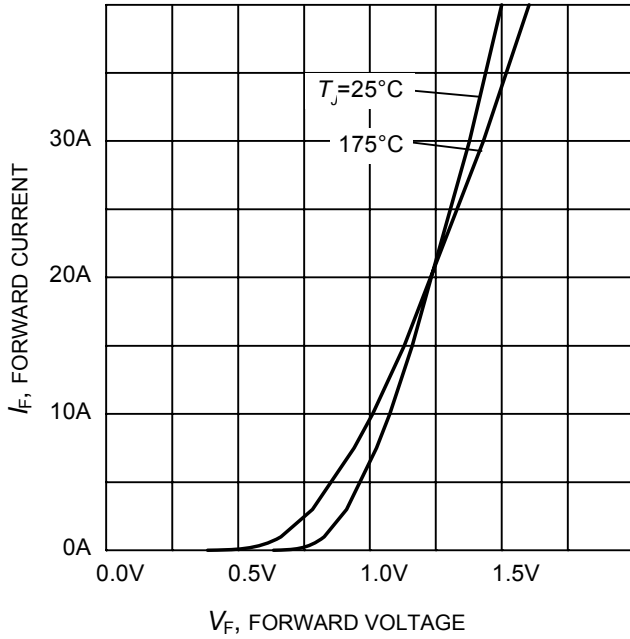

**Figure 20. Diode transient thermal impedance as a function of pulse width**  
( $D = t_p / T$ )



# IHW30N100T

## Soft Switching Series



**Figure 21. Typical diode forward current as a function of forward voltage**

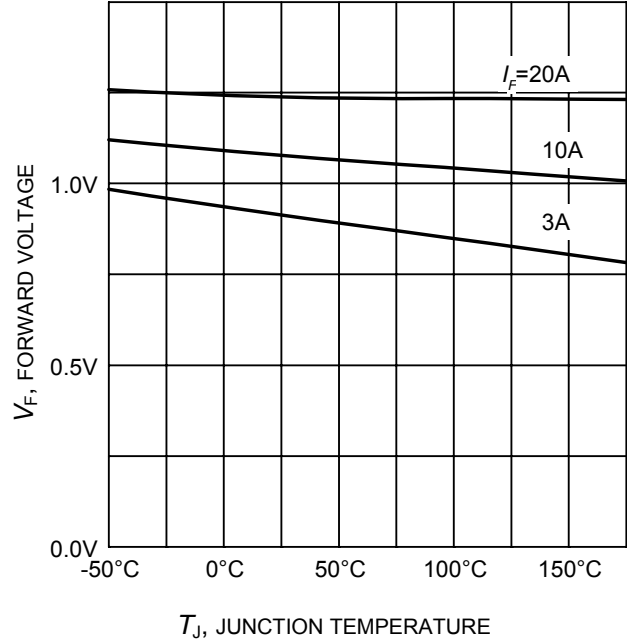

**Figure 22. Typical diode forward voltage as a function of junction temperature**



# IHW30N100T

Soft Switching Series

## PG-TO247-3

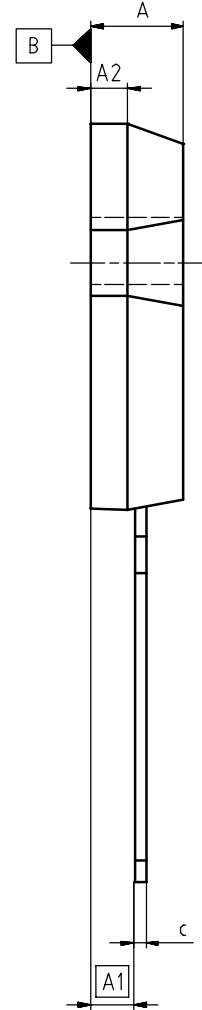
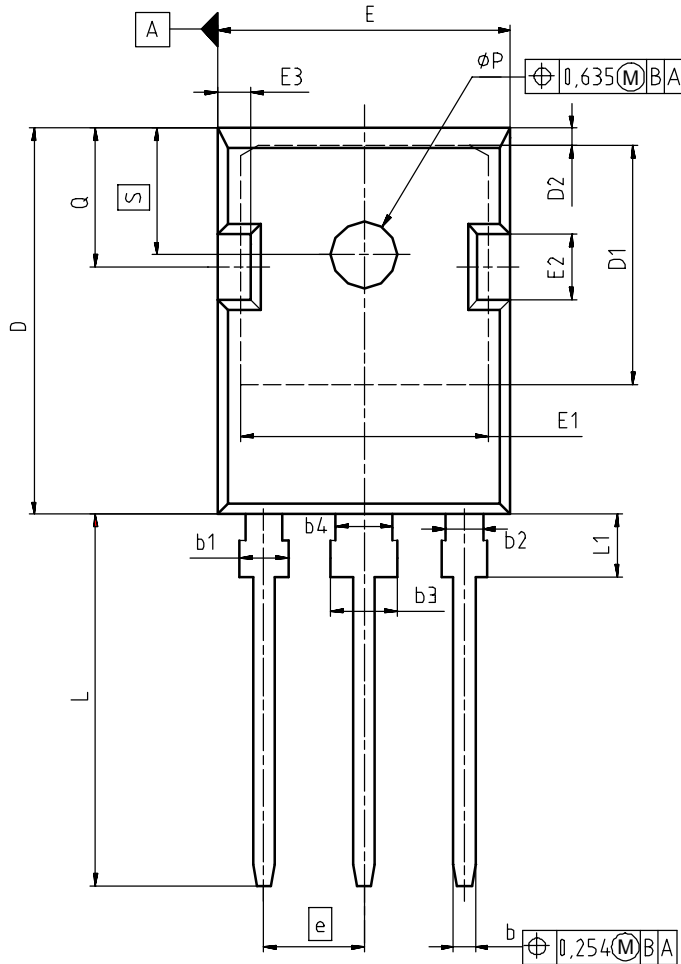

DIM	MILLIMETERS		INCHES	
	MIN	MAX	MIN	MAX
A	4.90	5.16	0.193	0.203
A1	2.27	2.53	0.089	0.099
A2	1.85	2.11	0.073	0.083
b	1.07	1.33	0.042	0.052
b1	1.90	2.41	0.075	0.095
b2	1.90	2.16	0.075	0.085
b3	2.87	3.38	0.113	0.133
b4	2.87	3.13	0.113	0.123
c	0.55	0.68	0.022	0.027
D	20.82	21.10	0.820	0.831
D1	16.25	17.65	0.640	0.695
D2	1.05	1.35	0.041	0.053
E	15.70	16.03	0.618	0.631
E1	13.10	14.15	0.516	0.557
E2	3.68	5.10	0.145	0.201
E3	1.68	2.60	0.066	0.102
e	5.44		0.214	
N	3		3	
L	19.80	20.31	0.780	0.799
L1	4.17	4.47	0.164	0.176
φP	3.50	3.70	0.138	0.146
Q	5.49	6.00	0.216	0.236
S	6.04	6.30	0.238	0.248

DOCUMENT NO.  
Z8B00003327

SCALE

EUROPEAN PROJECTION

ISSUE DATE  
17-12-2007

REVISION  
03



# IHW30N100T

## Soft Switching Series

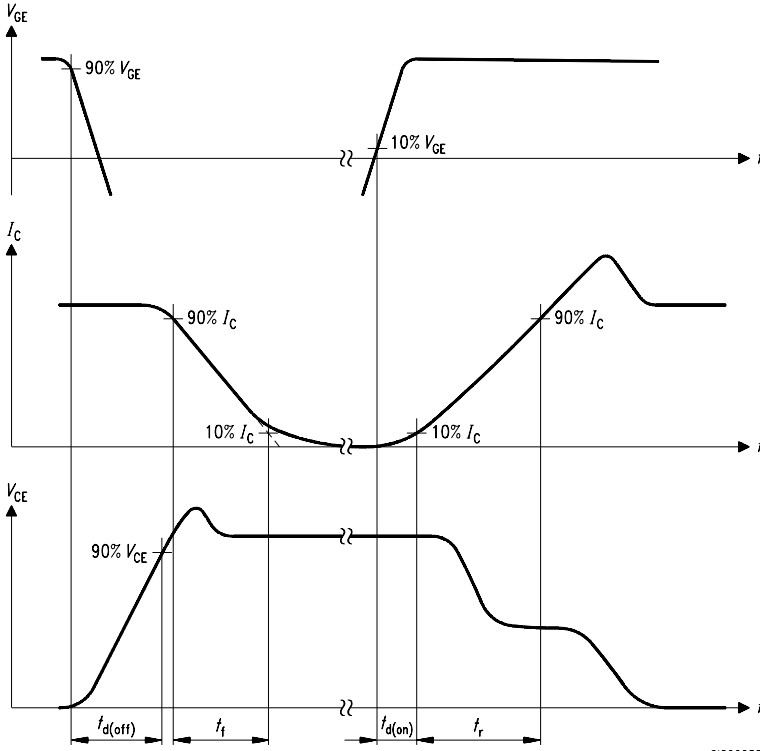

**Figure A. Definition of switching times**

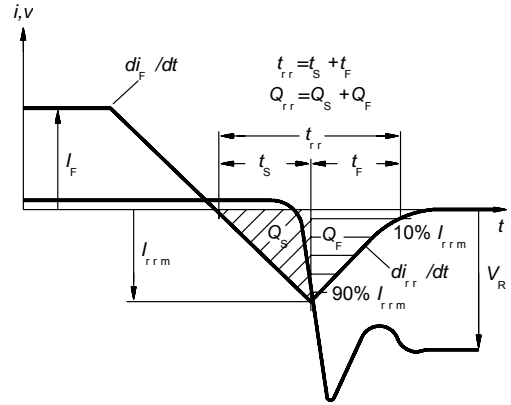

**Figure C. Definition of diodes switching characteristics**

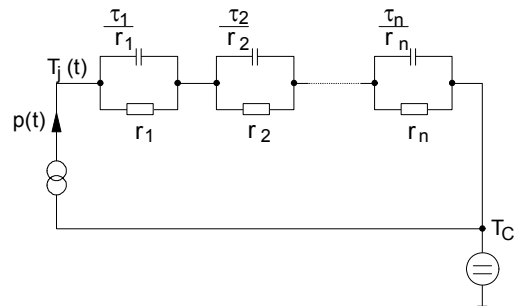

**Figure D. Thermal equivalent circuit**

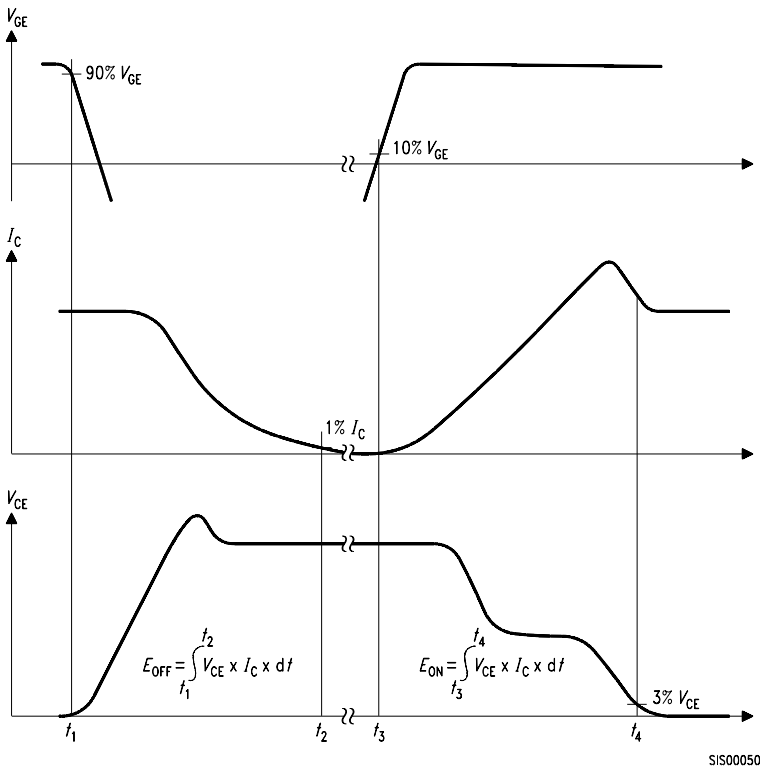

**Figure B. Definition of switching losses**

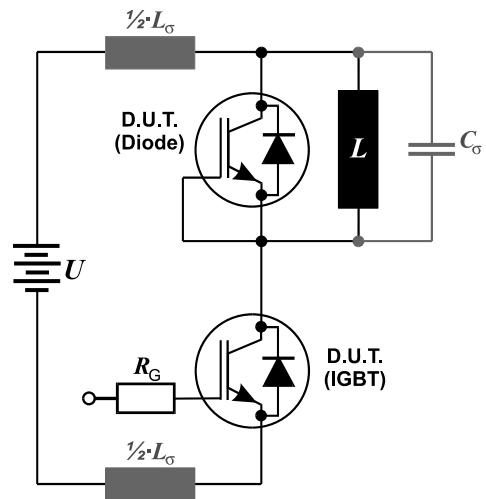

**Figure E. Dynamic test circuit**



# IHW30N100T

## Soft Switching Series

---

**Published by**  
**Infineon Technologies AG**  
**81726 Munich, Germany**  
**© 2008 Infineon Technologies AG**  
**All Rights Reserved.**

### Legal Disclaimer

The information given in this document shall in no event be regarded as a guarantee of conditions or characteristics. With respect to any examples or hints given herein, any typical values stated herein and/or any information regarding the application of the device, Infineon Technologies hereby disclaims any and all warranties and liabilities of any kind, including without limitation, warranties of non-infringement of intellectual property rights of any third party.

### Information

For further information on technology, delivery terms and conditions and prices, please contact the nearest Infineon Technologies Office ([www.infineon.com](http://www.infineon.com)).

### Warnings

Due to technical requirements, components may contain dangerous substances. For information on the types in question, please contact the nearest Infineon Technologies Office. Infineon Technologies components may be used in life-support devices or systems only with the express written approval of Infineon Technologies, if a failure of such components can reasonably be expected to cause the failure of that life-support device or system or to affect the safety or effectiveness of that device or system. Life support devices or systems are intended to be implanted in the human body or to support and/or maintain and sustain and/or protect human life. If they fail, it is reasonable to assume that the health of the user or other persons may be endangered.