

## **Excellent Integrated System Limited**

Stocking Distributor

Click to view price, real time Inventory, Delivery & Lifecycle Information:

[Hammond Manufacturing](#)  
[1414N4PHS16K](#)

For any questions, you can email us directly:

[sales@integrated-circuit.com](mailto:sales@integrated-circuit.com)

## Type 4X Stainless Steel Junction Box *1414 N4 PH SS Series* Continuous Hinge Door with Clamps

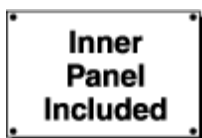

### Application

- Designed for use as instrument enclosures, electric, hydraulic or pneumatic control housings, electrical junction boxes or terminal wiring enclosures.
- Provides protection where equipment may be hosed down or otherwise be very wet, or in specific applications where corrosion may be a problem.

### Standards

- UL 508 Type 3R, 4, 4X, 12 and 13
- CSA Type 3R, 4, 4X, 12 and 13
- Complies with
  - NEMA Type 3R, 4, 4X, 12 and 13
  - JIC EGP-1-1967
  - IEC 60529, IP66

### Construction

- Formed from 14 gauge 304 or 316 stainless steel.
- Smooth, continuously welded seams.
- Welded brackets provide for enclosure mounting.
- Continuous stainless steel hinged cover is secured with stainless steel clamps and screws.
- Seamless poured-in place gasket.
- All models include a removable 14 gauge inner panel.
- Tapped studs are provided for mounting inner panels.
- A bonding stud is provided on the door and a grounding stud is provided in the enclosure.

### Finish

- Cover and enclosure are natural stainless steel with a smooth brushed finish.
- Removable inner panel is finished in white powder coating.

### Accessories

- |                                      |                           |
|--------------------------------------|---------------------------|
| • Inner Panels                       | • Ventilation             |
| • Door Clamping Hardware             | • Filtered Fans           |
| • Heaters                            | • Terminal Kit Assemblies |
| • Type 1 Louvered Ventilating Plates | • Temperature Controls    |
| • Window Kits                        | • Ground Wire Kits        |

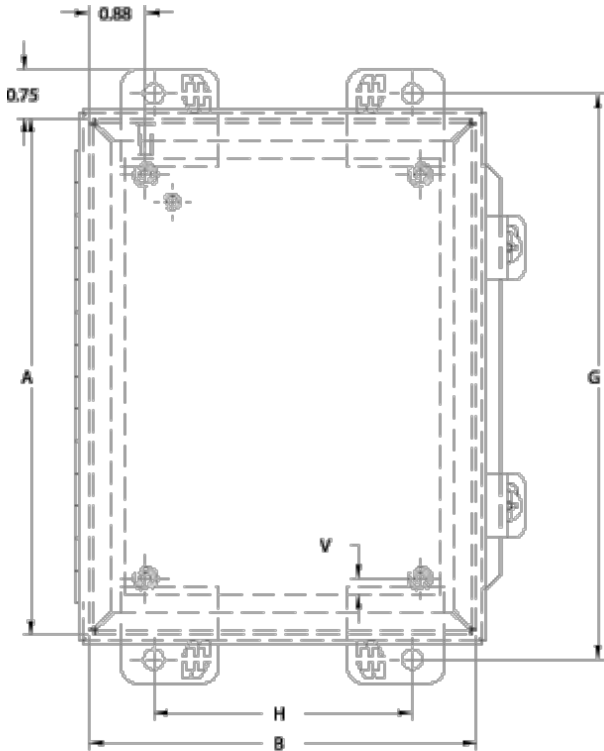

**Front View**

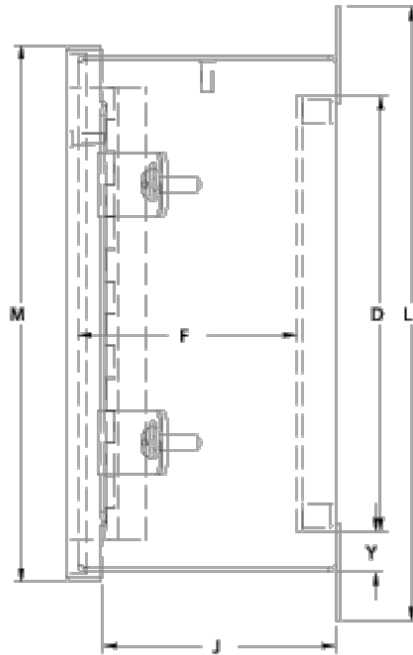

**Side View**

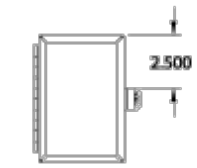

1414N4PHSSC4  
1414N4PHSSE

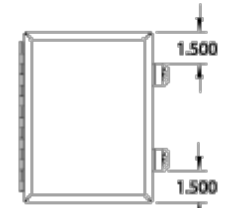

1414N4PHSSG  
1414N4PHSSG4  
1414N4PHSSI

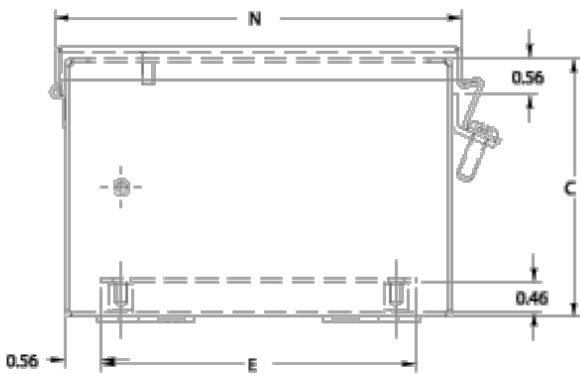

**Bottom View**

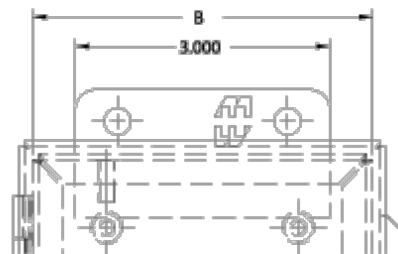

**Mounting Detail When B= 4**

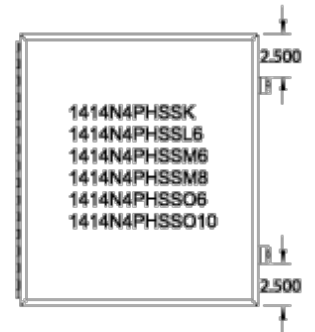

1414N4PHSSK  
1414N4PHSSL6  
1414N4PHSSM6  
1414N4PHSSM8  
1414N4PHSSO6  
1414N4PHSSO10

304 S.S. Part No.	316 S.S. Part No.	Overall Dimensions			Panel Size			Mount Centers				Cover Dimensions				Ship Wt. (lbs)
		A	B	C	D	E	F	G	H	J	L	M	N	V	Y	
1414N4PHSSC4	1414N4PHS16C4	6.00	4.00	4.00	4.88	2.88	3.50	6.75	2.00	3.60	7.50	6.31	4.31	0.31	0.56	5
1414N4PHSSE	1414N4PHS16E	6.00	6.00	4.00	4.88	4.88	3.50	6.75	4.00	3.60	7.50	6.31	6.31	0.31	0.56	6
1414N4PHSSG	1414N4PHS16G	8.00	6.00	3.50	6.75	4.88	3.00	8.75	4.00	3.10	9.50	8.31	6.31	0.25	0.63	6
1414N4PHSSG4	1414N4PHS16G4	8.00	6.00	4.00	6.75	4.88	3.50	8.75	4.00	3.60	9.50	8.31	6.31	0.25	0.63	8
1414N4PHSSI	1414N4PHS16I	10.00	8.00	4.00	8.75	6.88	3.50	10.75	6.00	3.60	11.50	10.31	8.31	0.25	0.63	10
1414N4PHSSK	1414N4PHS16K	12.00	10.00	5.00	10.75	8.88	4.50	12.75	8.00	4.60	13.50	12.31	10.31	0.25	0.63	15
1414N4PHSSK6	1414N4PHS16K6	12.00	10.00	6.00	10.75	8.88	6.00	12.75	8.00	4.60	13.50	12.31	10.31	0.25	0.63	16
1414N4PHSSL6	1414N4PHS16L6	12.00	12.00	6.00	10.75	10.88	5.50	12.75	10.00	5.60	13.50	12.36	12.31	0.25	0.63	20
1414N4PHSSM6	1414N4PHS16M6	14.00	12.00	6.00	12.75	10.88	5.50	14.75	10.00	5.60	15.50	14.31	12.31	0.25	0.63	21
1414N4PHSSO6	1414N4PHS16O6	16.00	14.00	6.00	14.75	12.88	5.50	16.75	12.00	5.60	17.50	16.31	14.31	0.25	0.63	26
1414N4PHSSM8	1414N4PHS16M8	14.00	12.00	8.00	12.75	10.88	7.50	14.75	10.00	7.60	15.50	14.31	12.31	0.25	0.63	22
1414N4PHSSO10	1414N4PHS16O10	16.00	14.00	10.00	14.75	12.88	9.50	16.75	12.00	9.60	17.50	16.31	14.31	0.25	0.63	28



**Distributor of Hammond Manufacturing: Excellent Integrated System Limited**

Datasheet of 1414N4PHS16K - BOX S STEEL NATURAL 12"L X 10"W

Contact us: [sales@integrated-circuit.com](mailto:sales@integrated-circuit.com) Website: [www.integrated-circuit.com](http://www.integrated-circuit.com)

---

© 2016. Hammond Manufacturing Ltd. All rights reserved.