



Distributor of Semtech: Excellent Integrated System Limited

Datasheet of SC443ULTRT - IC LED Driver DC DC Regulator PWM Dimming 30mA Backlight
16-MLP (3x3)

Contact us: sales@integrated-circuit.com Website: www.integrated-circuit.com

Excellent Integrated System Limited

Stocking Distributor

Click to view price, real time Inventory, Delivery & Lifecycle Information:

[Semtech](#)

[SC443ULTRT](#)

For any questions, you can email us directly:

sales@integrated-circuit.com



High Efficiency Integrated Boost Driver for 3-Strings of 30mA LEDs

POWER MANAGEMENT

Features

- Wide input voltage range from 4.5V to 27V
- 42V maximum operating output voltage
- Programmable LED current for up to 30mA per string
- **+/- 1% typical string-to-string current matching**
- **Greater than 90% efficiency**
- Wide 0.4% to 100% PWM dimming range
- **Integrated 1A power switch**
- Programmable switching frequency for small size
- Low current sense voltage for high efficiency
- Adjustable OVP for cost-effective output cap selection
- LED open circuit protection
- Thermal protection with auto-recovery
- 3mm x 3mm x0.6mm MLP-UT-16 lead-free package (WEEE and RoHS compliant)

Applications

- Small to Medium Size LCD Panel
- Notebook Display
- White LED Power Supplies
- Sub-Notebook and Tablet Computer Displays
- Portable Media Players
- LCD Monitors
- Digital Video Cameras

Description

The SC443 is a high-efficiency multiple string WLED driver with an integrated boost converter. It operates over a wide input range from 4.5V to 27V with a maximum output voltage of 42V and a 1A internal power switch.

It can drive 3 strings with current up to 30mA per string. The string-to-string current matching is within, typically, 1% and the overall efficiency is greater than 90% due to the low current sense voltage and a low-impedance internal power switch. The wide PWM dimming range boasts a ratio of 250: 1.

The programmable switching frequency enables the user to optimize the external component sizes for high efficiency. When there are fewer LEDs in each string, users can use a lower output voltage protection level which yields an allowable reduction in associated costs, size and voltage ratings of the output capacitor.

The SC443 also features an open circuit LED protection function. It disables the corresponding strings with LED open while keeping other strings under normal operation. This feature allows LCD panels to remain viewable even under LED failure and wire disconnects. The internal thermal shutdown protects the IC from overheating at abnormal conditions. The SC443 is available in a 3mm x 3mm x 0.6mm MLP-UT 16 Lead-free package.

Typical Application Circuit

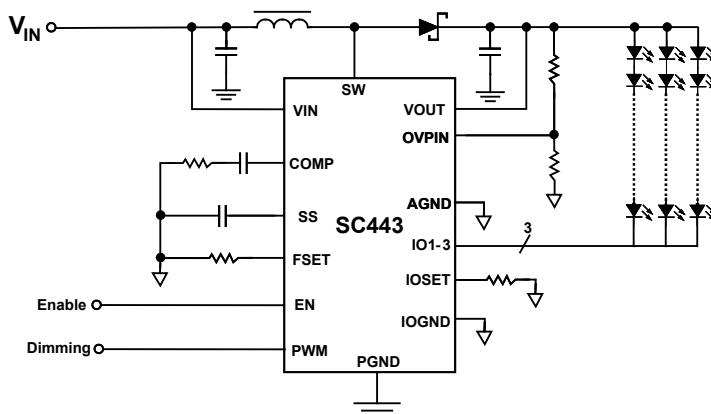



Pin Configuration

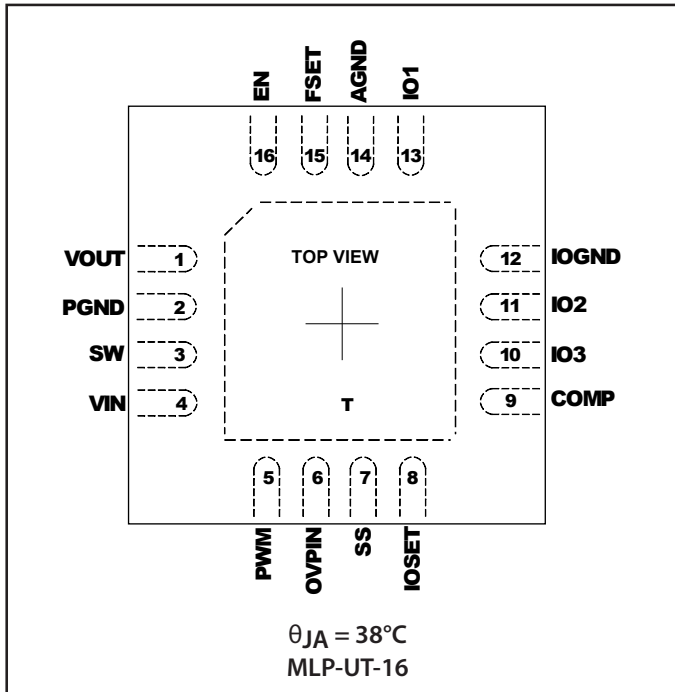

Ordering Information

Device	Package
SC443ULTRT ⁽¹⁾⁽²⁾	3 x 3 x 0.6mm MLP-UT 16
SC443EVB	Evaluation Board

Notes:

- (1) Available in tape and reel only. A reel contains 3,000 devices.
- (2) Available in lead-free package only. Device is WEEE and RoHS compliant.

Marking Information

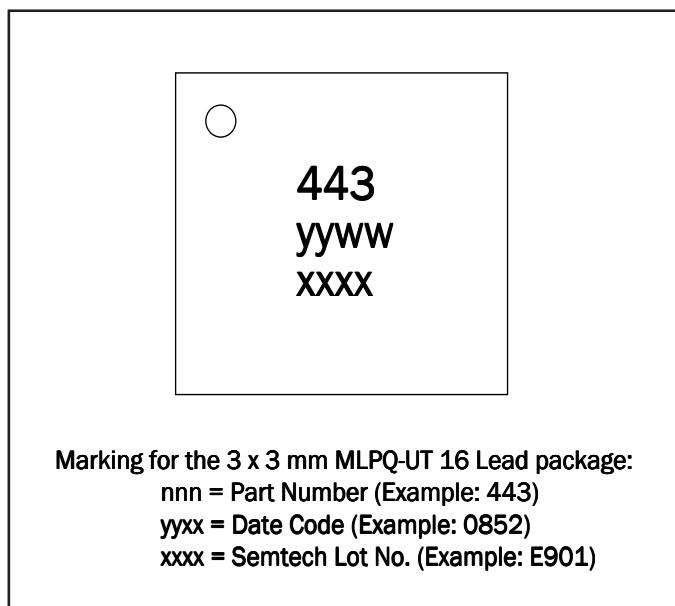



Absolute Maximum Ratings

V_{IN} Pin: Supply Voltage	-0.3 to 30V
Maximum Output Power	4W
FSET, IOSET Voltage	-0.3 to 2V
SW, VOUT, IO1~IO3, OVPIN Voltage	0.3V to 45V
SS, COMP Voltage	-0.3 to 3V
EN, PWM Voltage	-0.3 to $V_{IN} + 0.3V$
PGND to AGND and IOGND.....	$\pm 0.3V$
Peak IR Reflow Temperature	260°C
ESD Protection Level ⁽²⁾	2kV

Recommended Operating Conditions

Supply Input Voltage	4.5 to 27V
Maximum Output Voltage.....	42V
Maximum LED Current	30mA

Thermal Information

Junction to Ambient ⁽¹⁾	38°C/W
Maximum Junction Temperature.....	150°C
Storage Temperature	-65 to +150°C
Lead Temperature (Soldering) 10 sec	260°C

Exceeding the above specifications may result in permanent damage to the device or device malfunction. Operation outside of the parameters specified in the Electrical Characteristics section is not recommended.

NOTES--:

- (1) Calculated from package in still air, mounted to 3" x 4.5", 4 layer FR4 PCB with thermal vias under the exposed pad per JESD51 standards.
- (2) Tested according to JEDEC standard JESD22-A114-B.

Electrical Characteristics

Unless otherwise noted, $V_{IN} = 12V$, $-40^\circ C < T_A = T_J < 85^\circ C$, $R_{IOSET} = 4.02k\Omega$, $R_{FSET} = 40.2 k\Omega$

Parameter	Symbol	Conditions	Min	Typ	Max	Units
Input Supply						
Under-Voltage Lockout Threshold	U_{VLO-TH}	V_{IN} rising		4.2	4.45	V
UVLO Hysteresis	U_{VLO-H}			250		mV
V_{IN} Quiescent Supply Current	I_{IN-Q}	No switching		3		mA
V_{IN} Supply Current in Shutdown	I_{IN-S}	EN / PWM = low			1	μA
Oscillator						
Switching Frequency ⁽¹⁾	f_S	$R_{FSET} = 40.2 k\Omega$	0.64	0.8	0.96	MHz
Switching Frequency Range ⁽¹⁾	f_S		200		1200	kHz
Maximum Duty Cycle ⁽¹⁾	D_{MAX}		90			%
Minimum Duty Cycle ⁽¹⁾	D_{MIN}				0	%
Minimum On-Time	T_{ON-MIN}			200		ns
Internal Power Switch						
Switch Current Limit	I_{SW}		1			A
Switch Saturation Voltage	V_{SAT}	$I_{SW} = 500mA$		200	400	mV
Switch Leakage Current	I_{S-LEAK}	$V_{SW} = 12V$		0.01	1	μA



Electrical Characteristics (continued)

Unless otherwise noted, $V_{IN} = 12V$, $-40^{\circ}C < T_A = T_J < 85^{\circ}C$, $R_{\theta_{JOSET}} = 4.02k\Omega$, $R_{FSET} = 40.2k\Omega$.

Parameter	Symbol	Conditions	Min	Typ	Max	Units
Compensation						
Sourcing Current	I_{O-H}	VCOMP = 0.5V, $T_J = 25^{\circ}C$		7		μA
Sinking Current	I_{O-L}	VCOMP = 2V, $T_J = 25^{\circ}C$		5		μA
Control Signals						
EN, PWM High Voltage	V_{EN-H}	VIN = 4.5V to 27V	2			V
EN, PWM Low Voltage	V_{EN-L}	VIN = 4.5V to 27V			0.4	V
EN, PWM Leakage Current	$I_{EN-LEAK}$	VEN = VPWM = 0V to 5.0V		0.01	1	μA
PWM Dimming Frequency ⁽¹⁾	f_{PWM}		50		50k	Hz
PWM Dimming Minimum Duty Cycle ⁽¹⁾	$D_{MIN-PWM}$	200Hz		0.4		%
PWM Dimming Minimum Pulse Width	$T_{PWM-MIN}$	200Hz		20		μs
SS Source Current	I_{SS-H}	Vss = 0V		5		μA
SS Sink Current	I_{SS-L}	Vss = 2V at OVP or OTP		1.5		
SS Switching Threshold	V_{SS-TH}	$T_J = 25^{\circ}C$	0.6	0.8	1	V
SS End Voltage	V_{SS-END}			2.6		V
Over-Voltage Protection						
OVPIN Threshold Voltage	$V_{OVPIN-TH}$		1.45	1.51	1.57	V
OVPIN Leakage Current	$I_{OVPIN-L}$	OVPIN = VIN = 27V		0.1	1	μA
VOUT Internal Pull-Down in Over-Voltage Fault	I_{OVP}			0.8		mA
VOUT Leakage Current	I_{VOUT-L}	VOUT = 40V		0.1		μA
Current Source (IO1 ~ IO3)						
Backlight Current Accuracy	IO1~IO3	EN, PWM = 1; $T_J = 25^{\circ}C$	27.8	29.9	32	mA
LED Current Matching		EN, PWM = 1; $T_J = 25^{\circ}C$		+/-1	+/-3	%
Overshoot Protection Threshold	IO1~IO3			0.95		V
Maximum LED Current	I_{O-MAX}		35			mA
IO Off Leakage Current	I_{O-LEAK}	EN = 0V, VIO1 ~ VIO3 = VIN		0.1	1	μA
Over-Temperature Protection						
Thermal Shutdown Temperature	T_{OTP}			150		$^{\circ}C$
Thermal Shutdown Hysteresis	T_{OTP-H}			10		$^{\circ}C$

Notes:

(1) Guaranteed by design.



Typical Characteristics

UVLO Threshold vs. Temperature

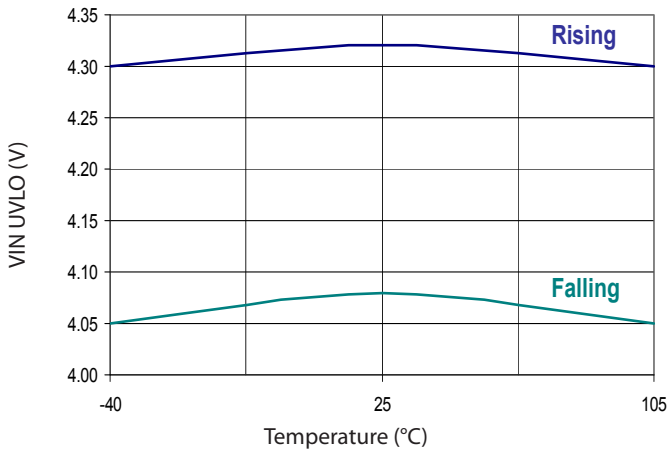

Switching Frequency vs. Temperature

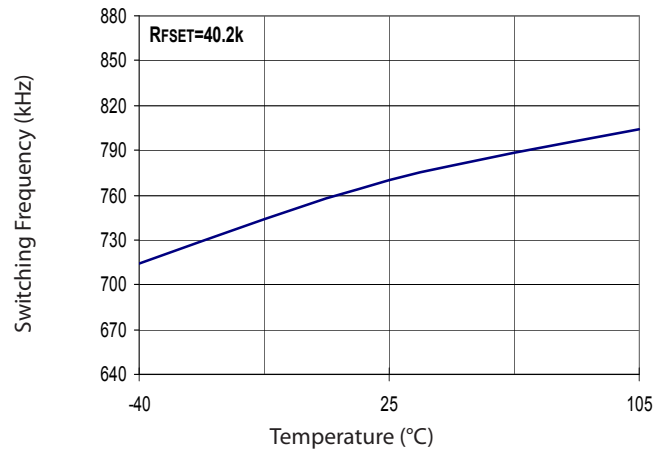

Switch Current Limit vs. Temperature

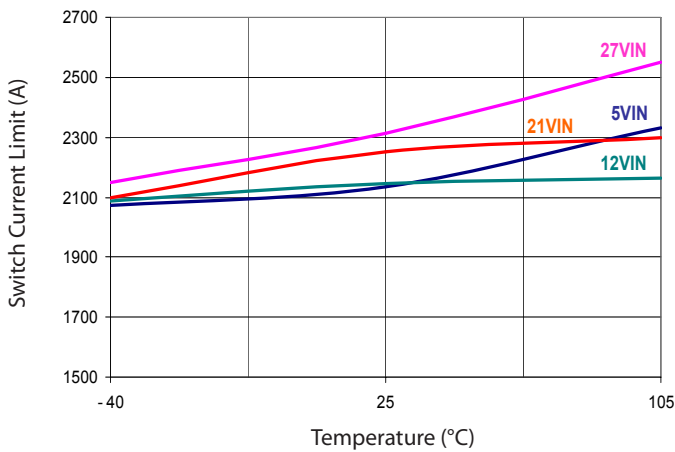

COMP Current vs. Temperature

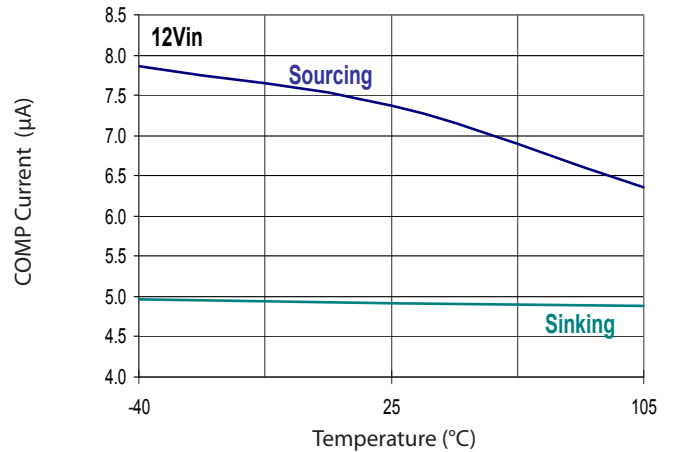

OVPIN Threshold vs. Temperature

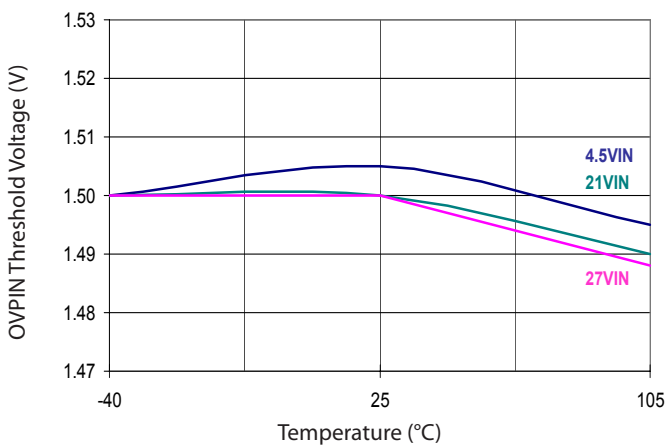

SS Current vs. Temperature

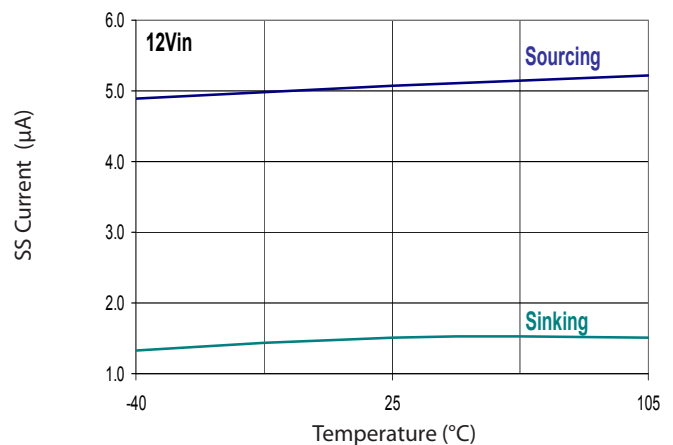



Typical Characteristics (continued)

VOUT Pull Down Current vs. Temperature

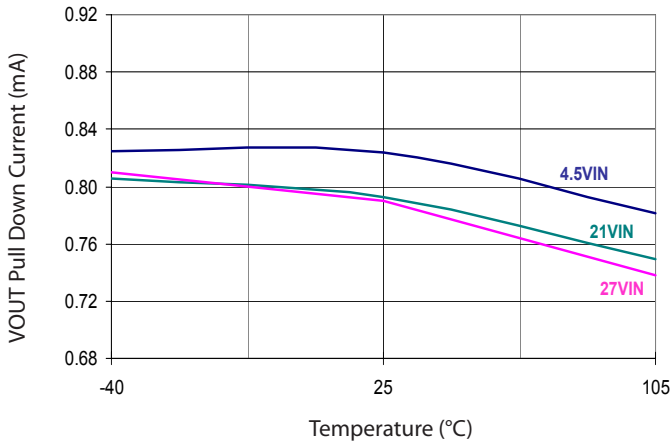

Efficiency vs. Input Voltage

VOUT=33V, D1=SS14, L1=B1000AS-220M, Co=10uF

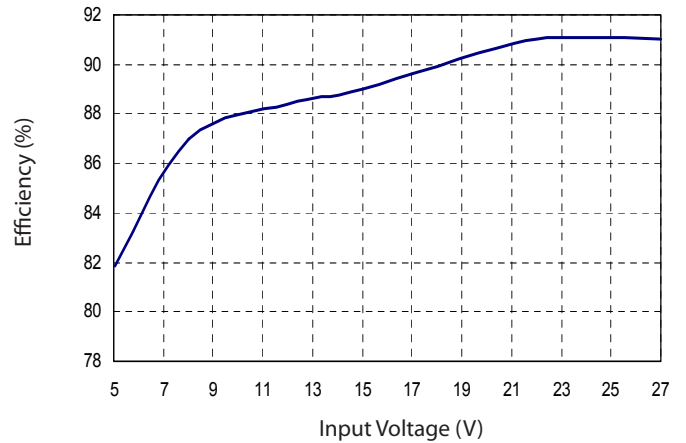

LED Current Setting vs. Temperature

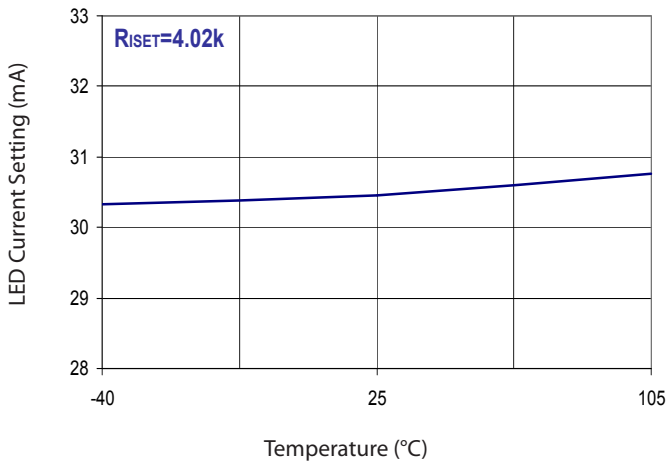

PWM Dimming Duty Cycle

Vin=12V, L= 15uH, Cout= 10uF, 10*LED,3string, Ta=25°C,

Switching Frequency=800KHz

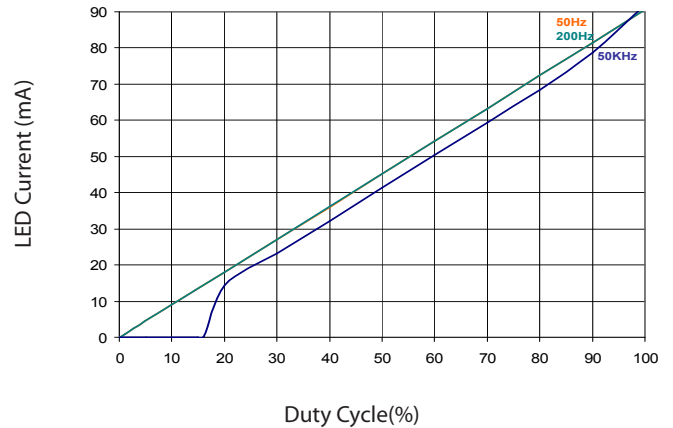

Switching frequency setting

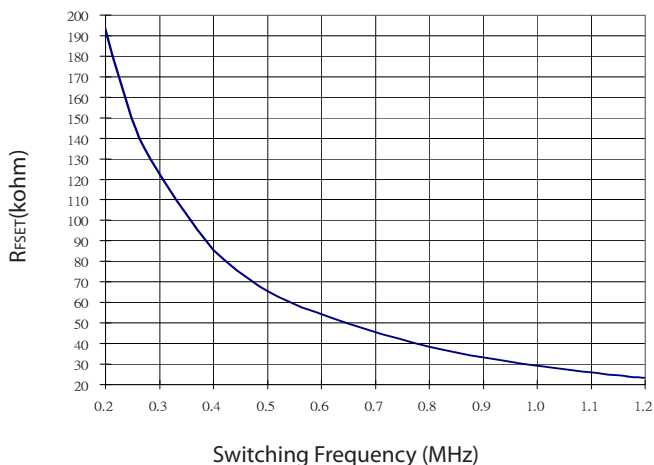



Typical Characteristics (continued)

Start UP by Vin

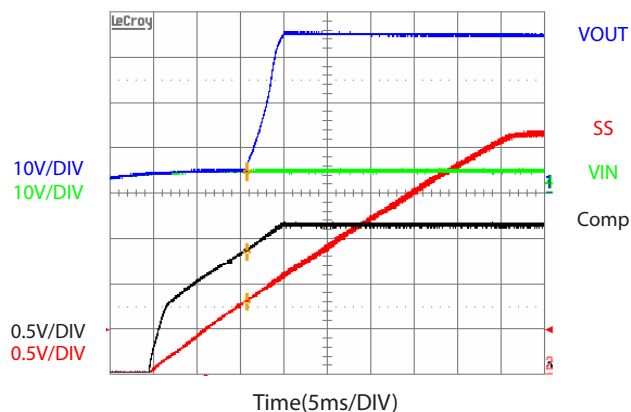

Condition: VIN=5V, Load=30mA x3 string, 10LEDs per string

Shutdown by Vin

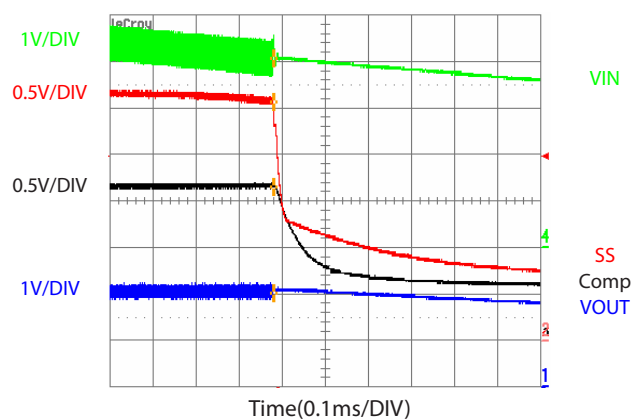

Condition: VIN=12V, Load=30mA x3 string, 10LEDs per string

Start up and Shutdown by EN

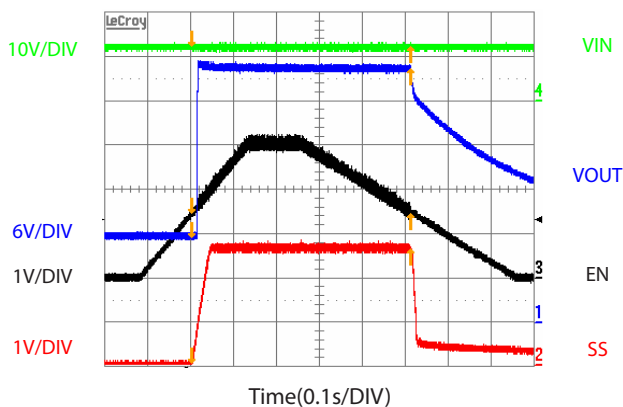

Condition: VIN=12V, Load=30mA x3 string, 10LEDs per string

Start up and Shutdown by PWM

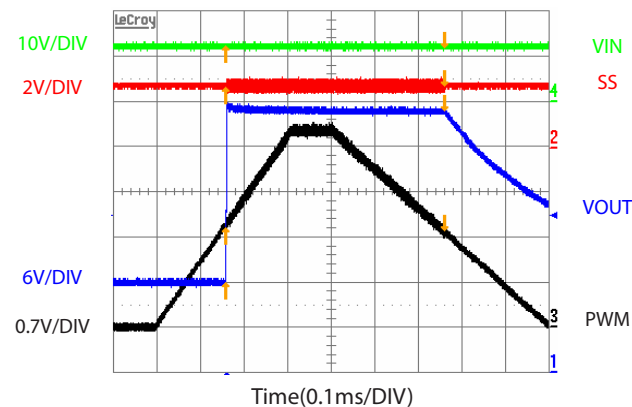

Condition: VIN=12V, Load=30mA x3 string, 10LEDs per string

Main Power Switching Waveform

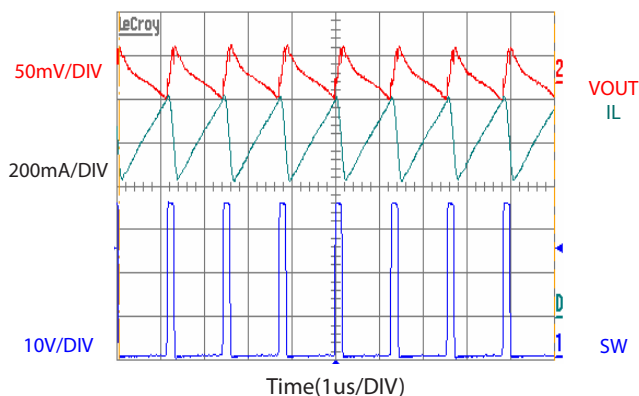

Condition: VIN=4.5V, Load=30mA x3 string, 10LEDs per string

LED OPEN

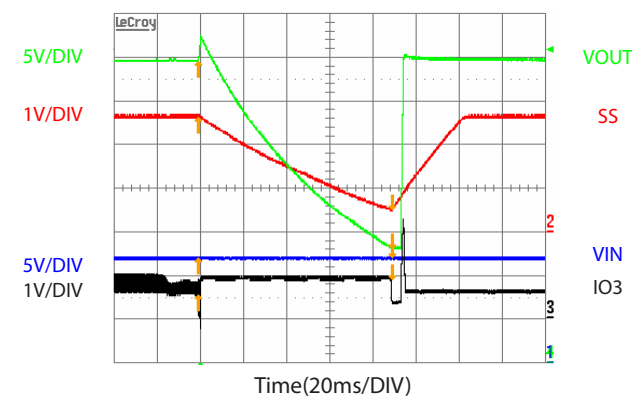

Condition: VIN=12V, Load=30mA x3 string, 10LEDs per string



Typical Characteristics (continued)

OTP

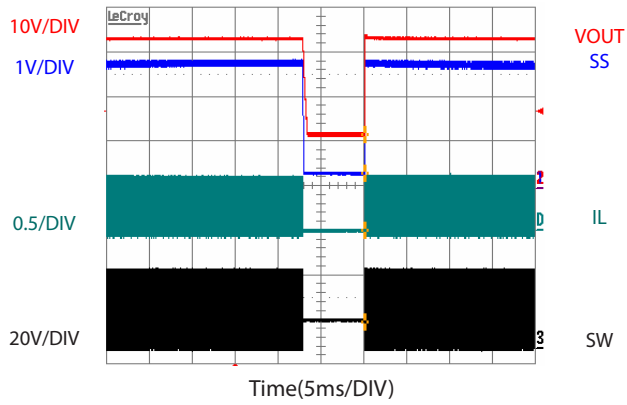

Condition: VIN=12V, Load=30mA x3 string, 10LEDs per string

Adaptor Plug-in

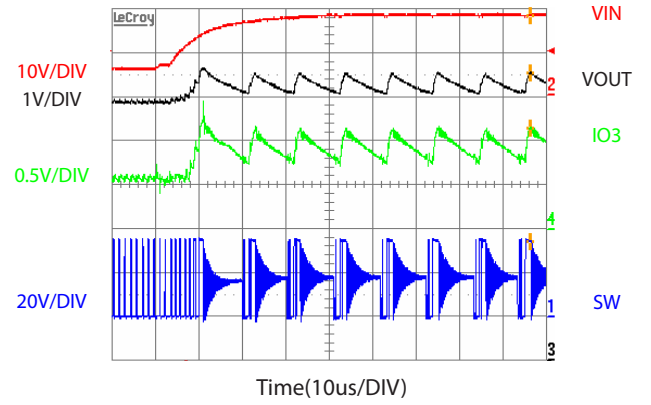

Condition: VIN=6V~18V, Load=30mA x3 string, 10LEDs per string

PWM Dimming

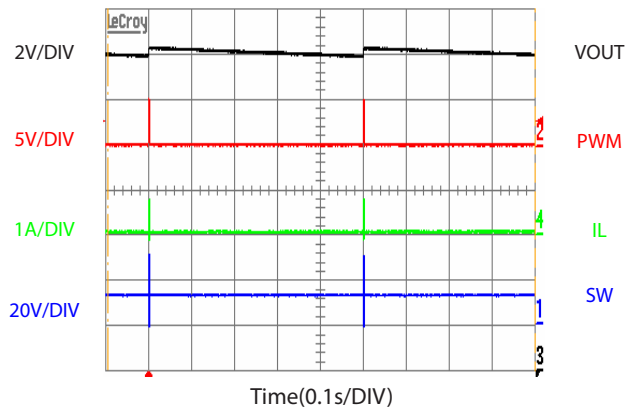

Condition: VIN=12V, Load=30mA x3 string, 10LEDs per string



Pin Descriptions

Pin #	Pin Name	Pin Function
1	VOUT	Output voltage pin and internal pull down current source in over voltage fault. Connect the output capacitor and the anode of the LED strings to this pin.
2	PGND	Power ground
3	SW	Collector of the internal power transistor – connect to the boost inductor and the rectifying diode.
4	VIN	Input voltage supply for IC. Bypassed with capacitors close to the pin.
5	PWM	PWM control pin for LED backlight strings, Connect to GND to disable the IO's.
6	OVPIN	Over-voltage input
7	SS	Soft-start pin
8	IOSET	Current source IO value set pin – by selecting the resistor connected from this pin to GND, the corresponding maximum current on all 3 strings are set.
9	COMP	The output of the internal transconductance error amplifier – this pin is used for loop compensation.
10	IO3	Provides constant source current to LED string 3.
11	IO2	Provides constant source current to LED string 2.
12	IOGND	LED ground
13	IO1	Provides constant current source to LED string 1.
14	AGND	Analog ground
15	FSET	External resistor setting switching frequency
16	EN	Enable the device including regulator and LED drivers.
T	Thermal Pad	Thermal pad for heatsinking purposes – connect to ground plane using multiple vias – not connected internally.

Table 1.

EN	STATUS
0	backlight disable
1	backlight enable

Note: When EN = 0; the boost is turned OFF and disabled.



Block Diagram

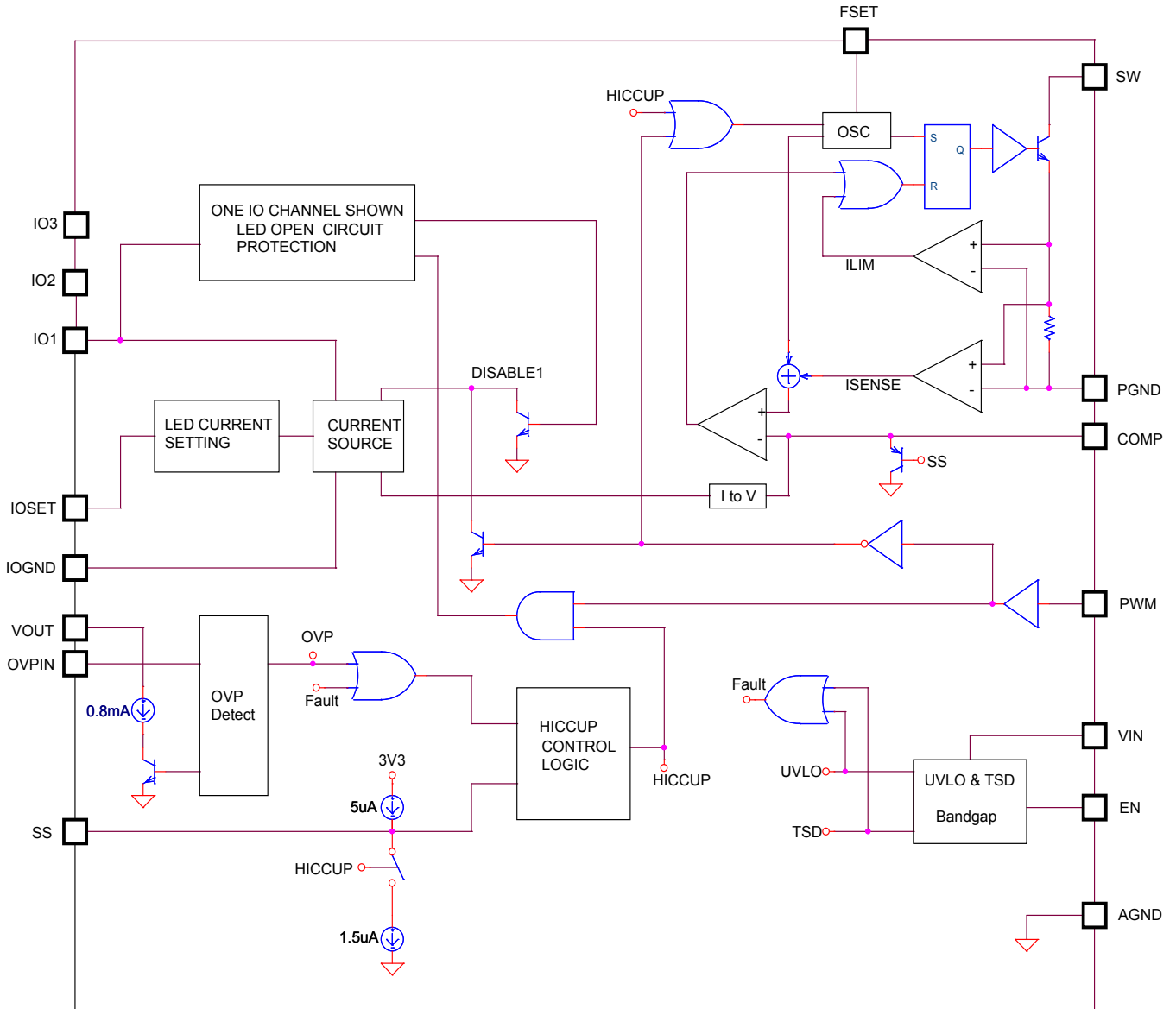

Figure 1. SC443 Block Diagram



Applications Information

SC443 Detailed Description

The SC443 contains a high frequency, current-mode boost regulator and three string LED current sources. The LED current for all strings is programmed by an external resistor and the PWM controller operates to maintain the output voltage at a level which will keep the current of each string regulated. A typical application would use 3-8 backlight LEDs for each string, driven with approximately 30mA.

Operation

The SC443 regulates the boost converter output voltage based on instantaneous requirements of the three string current sources. Therefore, only a single inductor and power switch is needed to provide power to the entire lighting subsystem, increasing efficiency and reducing part count. A logic interface to output control circuit has high-bandwidth, and supports PWM dimming with 50Hz to 50kHz dimming frequency while the entire supply current is reduced to 3mA (typical) when all LED strings are off.

High frequency switching provides high output power using a 1.0mm height inductor, maximizing efficiency for space-constrained and cost-sensitive applications. Additionally, the converter and output capacitor are protected from open-LED conditions by programmable over-voltage protection.

LED Current Programming

The SC443 is a LED current programmable regulator. The LED current set point is chosen using an external resistor connected to the IOSET pin. The relationship between the programming resistor value and the LED current set point of each string can be described as follows:

$$I_{LED} = 120/R_{IOSET}$$

Where, R_{IOSET} is in k Ω .

I_{LED} is the output current of each string in mA.

Start-Up

During start-up, when the VIN pin voltage reaches its UVLO threshold and both EN and PWM signals are set to high, the SS pin begins to source 5 μ A to the SS capacitor and its voltage begins to rise from 0V to its end value (2.6V). The output voltage of the internal error amplifier (COMP) is increased and clamped by the SS pin voltage. When the SS pin voltage reaches its switching threshold 0.8V(typical), the SC443 starts to switch and the output voltage increases.

Each internal LED current source (IO1 ~ IO3) tries to regulate the LED current to its set point. While the output voltage increases, a suitable amount of error information will be generated on the internal error amplifier as the COMP pin voltage keeps rising. Once each LED current reaches its set point, the error information is not generated by the LED current source. The COMP pin voltage stays at a level which keeps the LED current at its set point.

If the EN pin voltage is pulled below 0.4V and VIN reaches its UVLO, SC443 will stay at shutdown mode, drawing less than 1 μ A from the input power supply.

If the PWM pin voltage is pulled below 0.4V when the EN pin is pulled high and VIN reaches its UVLO, the SC443 runs in standby mode, drawing 3mA (typical) from the input power supply. Under this condition, soft-start is initiated and the SS pin voltage is raised to its end value since the EN pin is pulled high. After that, when PWM signal goes high to enable the device, the COMP pin voltage will rise as quickly as it can since it is not being limited by the SS pin. A proper capacitance (10nF ~ 100nF) is required for the COMP pin and its external RC network in order to prevent output voltage overshoot.

Shut Down

When the VIN pin voltage falls below its UVLO or EN pin voltage goes low while SC443 is at normal operation, SC443 will run in shutdown mode. The internal switch and LED current sources will be immediately turned off. The SS capacitor is discharged by SS pin internal current source and the SS pin voltage decreases to 0V. The output voltage falls to the same level as the input voltage.



Applications Information (continued)

If PWM pin voltage goes low while the SC443 is at normal operation, the device will run in standby mode. The internal switcher and the LED current sources will be immediately turned off. The SS pin will not be affected by the PWM signal and remains at its final value.

Main Power Stage Operation

SC443 is a programmable frequency, peak current-mode boost switching regulator with an integrated 1A (typical), power transistor. The switching frequency is programmable at the FSET pin. Referring to the Block Diagram on Page 10, the clock from the oscillation section resets the latch and turns on the power transistor. Switch current is sensed with an integrated sense resistor. The sensed current is summed with the slope-compensating ramp and fed into the modulating ramp input of the PWM comparator. The latch is set and the power transistor conduction is terminated when the modulating ramp intersects the error amplifier output (COMP).

The current-mode switching regulator is a dual-loop feedback control system. In the inner current loop, the EA output (COMP) controls the peak inductor current. In the outer loop, the error amplifier regulates the output voltage to keep the LED current in set point. The double reactive poles of the output LC filter are reduced to a single real pole by the inner current loop, allowing the simple loop compensation network to accommodate a wide range of input and output voltages.

Over-Current Protection

If the switch current exceeds 1A (the minimum current-limit trip point), the current-limit comparator, I_{LIM} will set the latch and immediately turn off the internal power switch. Due to separate pulse-width modulating and current limiting paths, the OCP trip point is not affected by slope compensation (i.e., trip point is not affected by switching duty cycle).

Over-Voltage Protection (OVP)

The SC443 includes an external programming over-voltage protection circuit to prevent damage to the IC and output capacitor in the event of an open-circuit condition. The output voltage of the boost converter is detected at

the OVPIN pin. If the voltage at the OVPIN pin exceeds 1.51V, the boost converter will shut off and a 0.8mA pull down current source will be applied to the VOUT pin to quickly discharge the over-voltage capacitor. This additional level of protection prevents a condition where the output capacitor and Schottky diode must endure high voltage for an extended period of time, which can pose a reliability risk for the system. The total resistance of the divider for the OVP protection should be more than 200kΩ.

The output over-voltage trip point can be programmed by R2 and R4 resistor divider (see the schematic on page 16). The relationship can be described as follows:

$$OVP_{TRIP} = V_{OVPIN_TH} * \frac{R2 + R4}{R4}$$

Where OVPIN_TH is 1.51V typical.

An OVP event causes a fault which disables the boost converter and enables the strong pull down, the soft-start capacitor is discharged. When the soft-start capacitor voltage falls below 0.5V and VOUT falls below 1V above VIN, the SC443 enters a soft-start process. The OVPIN pin is sensitive to noise and a proper decoupling cap, (1nF ~ 10nF) is required.

LED Open-Circuit Protection

If any LED is detected as open circuit, that string IO pin-voltage will be pulled low and less than 0.2V. When LED is opened, the output current is decreased at once, but the COMP pin voltage can't be pulled low at the same time, the boost converter duty cycle will be maintained causing VOUT to rise. Because of the open string, VOUT will continue to rise until it reaches the programmed OVP level.

When OVP is reached, the voltages on the IO pins are monitored. If any IO voltage is less than 0.2V, that string will be identified as open and will be latched off. Only VIN falling below UVLO, recycle EN signal, and thermal shutdown will reset this latch. When a hiccup cycle is initiated the SS is discharged slowly with a 1.5µA cur-



Applications Information (continued)

rent source and a 1mA discharge path is turned on to pull down VOUT. When SS falls below 0.5V and VOUT falls below 1V above VIN, the OVP detection latches are reset and a new soft-start sequence is initiated to resume normal operation.

Thermal Shutdown (TSD)

If the thermal shutdown temperature of 150°C is reached, a hiccup sequence is initiated where the boost converter and all IO current sources are turned off. SS is discharged by a 1.5µA current source, and a 1mA discharge path is turned on to pull down VOUT. As temperature falls below TSD trip point, the SC443 will retry once SS falls below 0.5V and VOUT falls below 1V above VIN.

PWM Dimming

The PWM input needs to be held high for normal operation. PWM dimming can be achieved by cycling the PWM input at a given frequency where a “low” on the PWM input turns off all IO current sources and a “high” turns on all IO current sources. The short and open detection latches are blanked for approximately 2µs as the PWM input transitions from low-to-high to prevent false fault detection during PWM dimming.

The PWM pin can be toggled by external circuitry to allow PWM dimming. In a typical application, a microcontroller sets a register, or counter, that varies the pulse width on a GPIO pin. The SC443 allows dimming over two decades in frequency (50Hz-50kHz) in order to allow compatibility with a wide range of devices including the newest dimming strategies that avoid the audio band by using high frequency PWM dimming. In this manner, a wide range of illumination can be generated while keeping the instantaneous LED current at its peak value for high efficiency and color temperature.

Furthermore, advanced lighting effects such as backlight dim-on can be implemented as the SC443 can resolve PWM from 10% to 90% duty at its highest frequency. Additionally, PWM dimming offers customers the ability to reduce in-rush current to the output capacitor. Simply apply the PWM signal to the device at 10% duty for a

millisecond or two, and in-rush current is reduced to less than 50mA. This dim time will vary based on the number of LEDs and the size of the output capacitor, but can be easily determined on the bench and programmed into the µC firmware.

Parallel Operation

When two or more SC443s are operating in parallel for a large-sized panel application, audible noise may be observed due to a non-synchronous switching frequency. The ripple voltage on the input voltage rail will be modulated by the beat frequency resulting in audible noise. This situation can be resolved by adding an input inductor between the input voltage rail and the VIN pin and can also be improved by adding more input decoupling capacitors.

Inductor Selection

The inductance value of the inductor affects the converter’s steady state operation, transient response, and its loop stability. Special attention needs to be paid to three specifications of the inductor, its value, its DC resistance and saturation current. The inductor’s inductance value also determines the inductor ripple current. The converter can operate in either CCM or DCM depending on its working conditions. The inductor DC current or input current can be calculated as,

$$I_{IN} = \frac{V_{OUT} \cdot I_{OUT}}{V_{IN} \cdot \eta}$$

I_{IN} - Input current;

I_{OUT} - Output current;

V_{OUT} - Boost output voltage;

V_{IN} - Input voltage;

η - Efficiency of the boost converter.

Then the boundary condition for CCM and DCM is,

$$D = \frac{V_{OUT} - V_{IN} + V_D}{V_{OUT} + V_D}$$

V_D = Forward conduction drop of the output rectifying diode.



Applications Information (continued)

When the boost converter runs in DCM ($L < L_{\text{boundary}}$), it takes advantage of small inductance and quick transient response while avoiding the bandwidth-limiting instability of the RHP zero found in CCM boost converters.

The inductor peak current is,

$$I_{L\text{-peak}} = \frac{V_{\text{IN}} \cdot D}{F_s \cdot L}$$

The converter will work in CCM if $L > L_{\text{boundary}}$. Generally the converter has higher efficiency under CCM and the inductor peak current is,

$$I_{L\text{-peak}} = I_{\text{IN}} + \frac{V_{\text{IN}} \cdot D}{2 \cdot F_s \cdot L}$$

For many applications an inductor with a value of 4.7μH to 22μH should be fine. The inductor peak current must be less than its saturation rating. When the inductor current is close to the saturation level, its inductance can decrease 20% to 35% from the 0A value depending on the vendor specifications. Using a small value inductor forces the converter into DCM, in which case the inductor current ramps down to zero before the end of each switching cycle. It also reduces the boost converter's maximum output current and produces large input voltage ripple. An inductor with larger inductance will reduce the bandwidth of the feedback loop and possibly higher DC resistance (DCR). Inductor's DCR plays a significant role for the total efficiency since the power transistor is integrated inside the SC443. Of course, there is a trade-off between the DCR and inductor size. Table 2 lists recommended inductors and their vendors.

Table 2. Recommended Inductors

Inductor	Website
DR74, 4.7μH ~ 15μH	www.cooperet.com
IHLP-2525CZ-01, 4.7μ ~ 10μH	www.vishay.com
DS85LC, 6.8μH ~ 10μH	www.tokoam.com

Output Capacitor Selection

The next task in design is targeting the proper amount of ripple voltage due to the constant-current LED loads. The two error amplifiers that control the PWM converter sense the delta between requested current and actual current in each output current regulator. On a cycle-by-cycle basis, a small amount of output ripple ensures good sensing and tight regulation, while the output current regulators keep each LED current at a fixed value. Overall, this allows usage of small output caps while ensuring precision LED current regulation. Although the mechanics of regulation and frequency dependence may be complex, actual selection of the output capacitor can be simplified because this capacitor is mainly selected for the output ripple of the converter. Assume a ceramic capacitor is used. The minimum capacitance needed for a given ripple can be estimated by,

$$C_{\text{OUT}} = \frac{(V_{\text{OUT}} - V_{\text{IN}}) \cdot I_{\text{OUT}}}{V_{\text{OUT}} \cdot F_s \cdot V_{\text{RIPPLE}}}$$

- V_{RIPPLE} – Peak-to-peak output ripple;
- I_{OUT} – Output current;
- V_{OUT} – Boost output voltage;
- V_{IN} – Input voltage;
- F_s – Switching frequency.

During load transient, the output capacitor supplies or absorbs additional current before the inductor current reaches its steady state value. Larger capacitance helps with the overshoot and undershoots during load transient, and loop stability. Recommended ceramic capacitor manufacturers are listed in Table 3.

Table 3. Recommended Ceramic Capacitor Manufacturers

Vendor	Phone	Website
Kemet	408-986-0424	www.kemet.com
Murata	814-237-1431	www.murata.com
Taiyo Yuden	408-573-4150	www.t-yuden.com



Applications Information (continued)

Output Rectifying Diode Selection

Schottky diodes are the ideal choice for SC443 due to their low forward voltage drop and fast switching speed. Table 4 shows several different Schottky diodes that work well with the SC443. Make sure that the diode has a voltage rating greater than the possible maximum output voltage. The diode conducts current only when the power switch is turned off. A diode of 1A will be sufficient for most designs.

Layout Guidelines

The SC443 contains a boost converter and the placements of the power components outside. The SC443 should follow the layout guidelines of a general boost converter. The application circuit on page 16 will be used as an example. The layout illustration diagram is shown on page 16. R5 and C7 form a decoupling filter for the SC443. C7 should be placed as close as possible to the VIN and PGND to achieve the best performance. C6 is the input power filtering capacitor for the boost converter power train. L1 is the boost converter input inductor. D1 is the output rectifying diode and it is recommended that a Schottky diode be used for fast reverse recovery.

To minimize switching noise for the boost converter, the output capacitor, C3, should be placed at the bottom, as displayed on page 17, so that the loop formed by C6, D1, and the internal switch, is the smallest. The output of the boost converter is used to power up the LEDs. R6 and C9 form the compensation network for the boost converter. C9 should return to analog ground.

Table 4. Recommended Rectifying Diodes

Part	Vendor
SS13	Vishay
SS14	www.vishay.com

C8 determines the soft-start time and should be connected to analog ground. R8 is the output current programming resistor for IO1 through IO3 and should return to analog ground. IOGND should also be connected to AGND.

Since there is pad at the bottom of the SC443 for heat dissipation, a copper area right underneath the pad is used for better heat spreading. On the bottom layer of the board another copper area connected through vias to the top layer, is used for better thermal performance. The pad at the bottom of the SC443 should be tied to the analog ground. The analog ground should be connected to the power ground at one point for better noise immunity.



Application Schematic

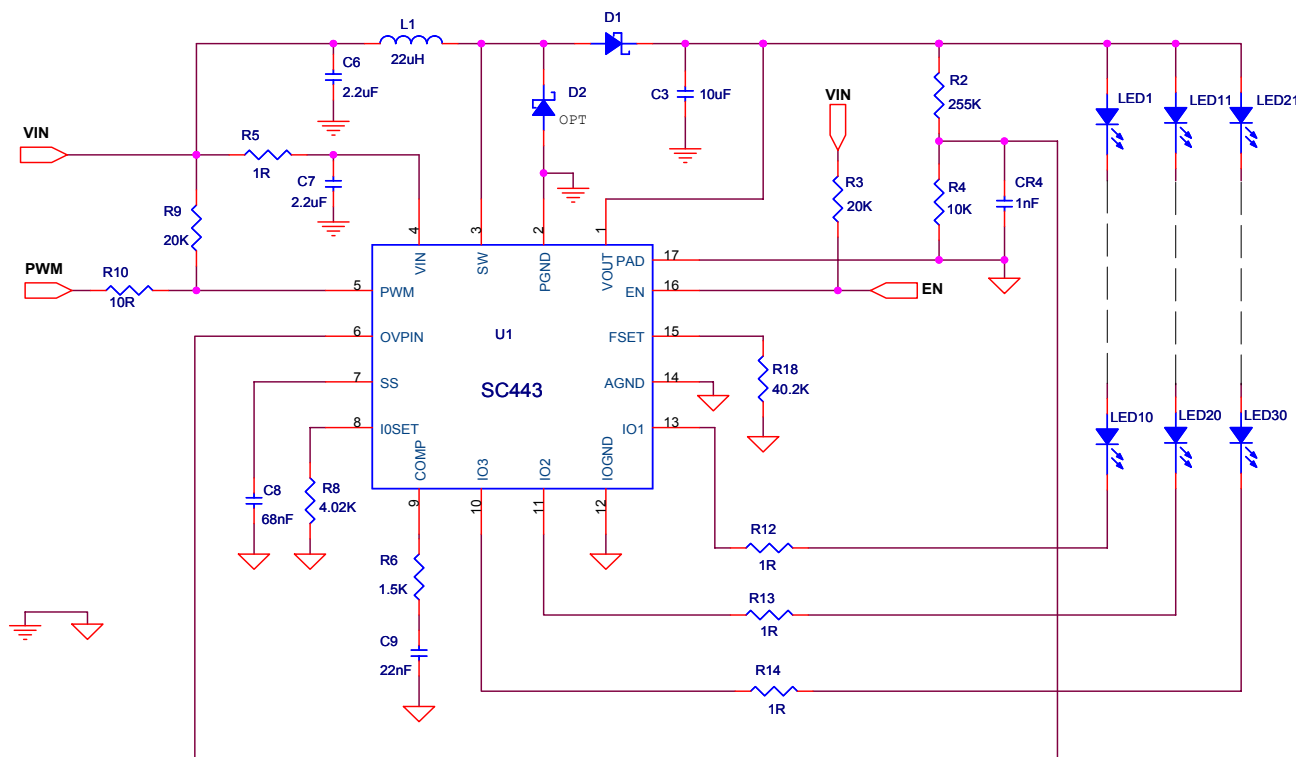

Evaluation Board Bill of Materials

Item	Quantity	Reference	Part
1	1	CR4	1nF
2	1	C3	10uF, 50V, 1210
3	2	C6, C7	2.2uF, 50V
4	1	C8	68nF
5	1	C9	22nF
6	1	D1	SS14
7	1	L1	22uH, TOKO B1000AS-220M
8	4	R5,R12,R13,R14	1R
9	1	R2	255K
10	1	R3, R9	20K
11	1	R4	10K
12	1	R6	1.5K
13	1	R8	4.02K
14	1	R10	10R
15	1	R18	40.2K
16	1	U1	SC443
17	30	LED1~30	SML-LX0603UWD



Layout Illustration Diagrams

PCB TOP

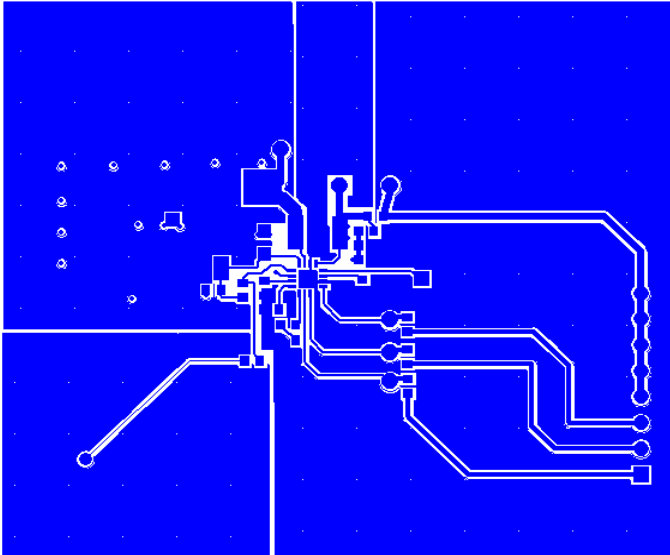

PCB BOTTOM

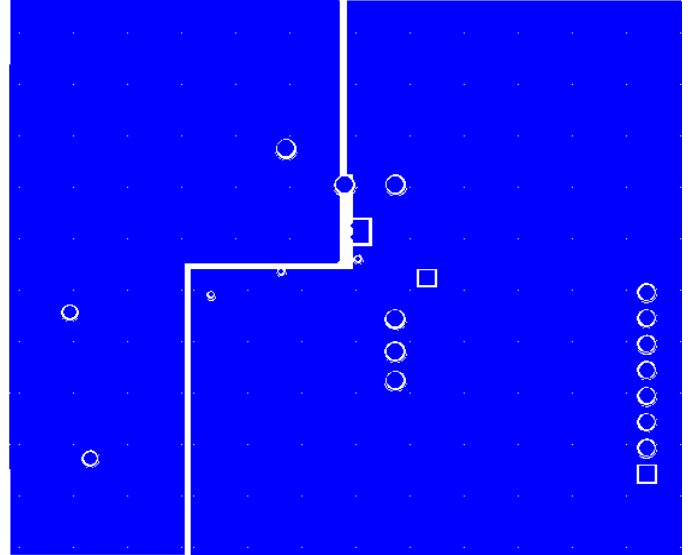

COMPONENT TOP

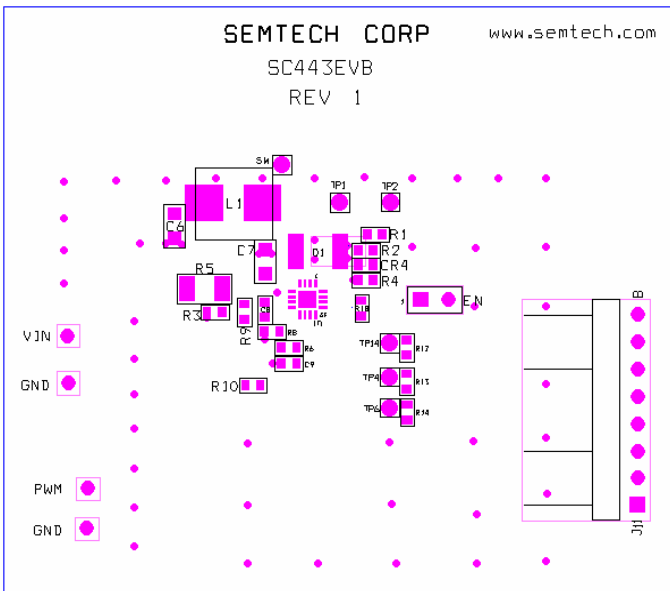

COMPONENT BOTTOM

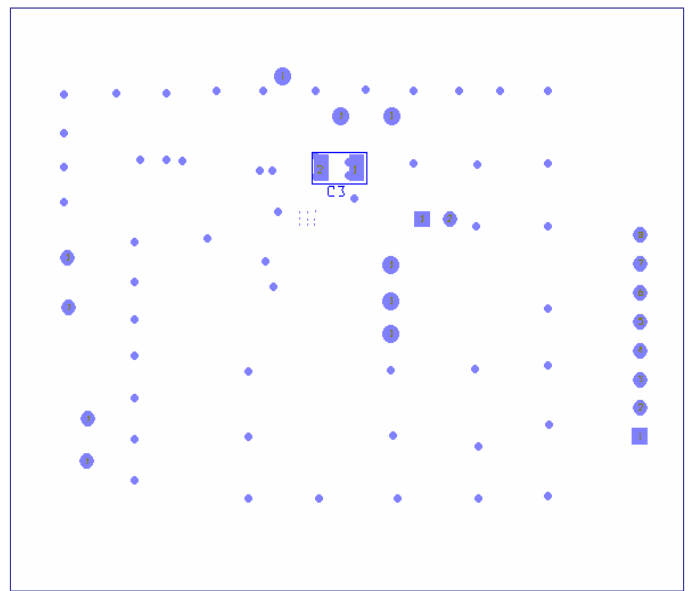



Outline Drawing - MLP-UT16

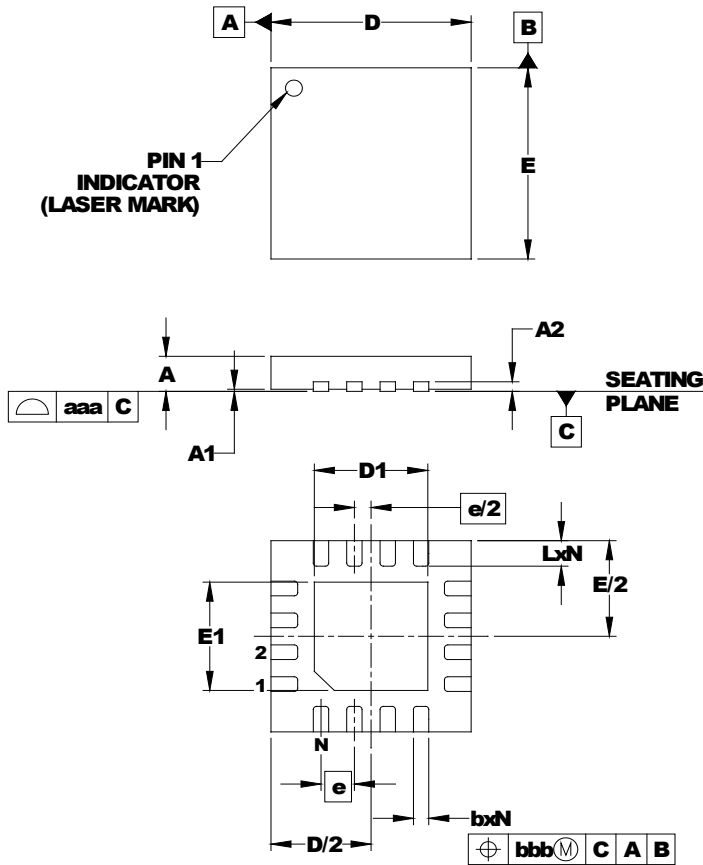

DIM	INCHES			MILLIMETERS		
	MIN	NOM	MAX	MIN	NOM	MAX
A	.020	-	.024	0.50	-	0.60
A1	.000	-	.002	0.00	-	0.05
A2	(.006)			(0.152)		
b	.007	.009	.012	0.18	0.23	0.30
D	.114	.118	.122	2.90	3.00	3.10
D1	.061	.067	.071	1.55	1.70	1.80
E	.114	.118	.122	2.90	3.00	3.10
E1	.061	.067	.071	1.55	1.70	1.80
e	.020 BSC			0.50 BSC		
L	.012	.016	.020	0.30	0.40	0.50
N	16			16		
aaa	.003			0.08		
bbb	.004			0.10		

NOTES:

1. CONTROLLING DIMENSIONS ARE IN MILLIMETERS (ANGLES IN DEGREES).
2. COPLANARITY APPLIES TO THE EXPOSED PAD AS WELL AS THE TERMINALS.
3. DAP IS 1.90 x 1.90mm.



Land Pattern - MLPQ-UT16

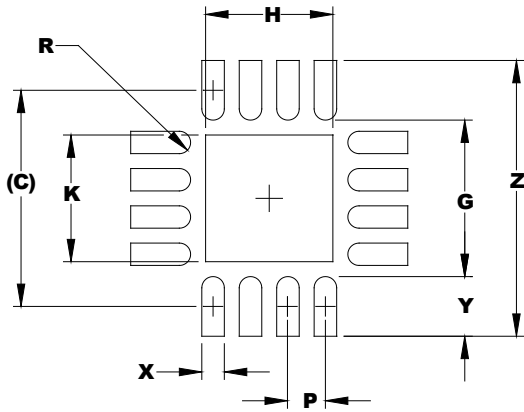

DIMENSIONS		
DIM	INCHES	MILLIMETERS
C	(.114)	(2.90)
G	.083	2.10
H	.067	1.70
K	.067	1.70
P	.020	0.50
R	.006	0.15
X	.012	0.30
Y	.031	0.80
Z	.146	3.70

NOTES:

- 1. CONTROLLING DIMENSIONS ARE IN MILLIMETERS (ANGLES IN DEGREES).**
- 2. THIS LAND PATTERN IS FOR REFERENCE PURPOSES ONLY. CONSULT YOUR MANUFACTURING GROUP TO ENSURE YOUR COMPANY'S MANUFACTURING GUIDELINES ARE MET.**
- 3. THERMAL VIAS IN THE LAND PATTERN OF THE EXPOSED PAD SHALL BE CONNECTED TO A SYSTEM GROUND PLANE. FAILURE TO DO SO MAY COMPROMISE THE THERMAL AND/OR FUNCTIONAL PERFORMANCE OF THE DEVICE.**

Contact Information

Semtech Corporation
 Power Management Products Division
 200 Flynn Road, Camarillo, CA 93012
 Phone: (805) 498-2111 Fax: (805) 498-3804

www.semtech.com