



Distributor of Molex Connector Corporation: Excellent Integrated System Limited
Datasheet of 5024940670 - Connector Receptacle 6 Position 0.079" (2.00mm) Tin Surface
Mount, Right Angle

Contact us: sales@integrated-circuit.com Website: www.integrated-circuit.com

Excellent Integrated System Limited

Stocking Distributor

Click to view price, real time Inventory, Delivery & Lifecycle Information:

[Molex Connector Corporation](#)
[5024940670](#)

For any questions, you can email us directly:
sales@integrated-circuit.com

Contact us: sales@integrated-circuit.com Website: www.integrated-circuit.com

- NOTES**
1. 嵌合相手 : 502439-**00
MATE WITH : 502439-**00
 2. 端子間距離及びネイルの寸法 : 0.1MAX.
TAIL AND NAIL COPLANARITY TO BE 0.1 MAX.
 3. 偶数極に適用。
APPLY FOR CKT. SIZE = EVEN.
 4. 端子テール部及びネイルに錫めつきを使用しているため、
外観に摺動痕が付く場合がございます。
THE WOUND OF FRICTION MIGHT ADHERE TO EXTERNALS
BECAUSE THE TIN PLATING IS USED FOR THE TAIL AND NAIL.
 5. 本製品のプラスチック部に黒点等が確認される場合や
色合いが異なる場合がありますが、製品性能に影響はありません。
THERE IS NO INFLUENCE IN THE PRODUCT PERFORMANCE THOUGH
THE BLACK SPOT ETC. MIGHT BE CONFIRMED TO THE PLASTIC PART
OF THIS PRODUCT AND THE SHADE MIGHT BE DIFFERENT.
 6. ELV 及び RoHS 適合品
ELV AND ROHS COMPLIANT

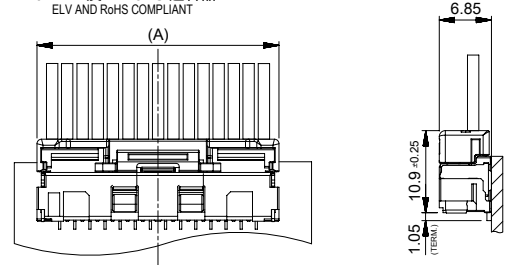
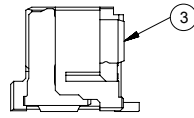
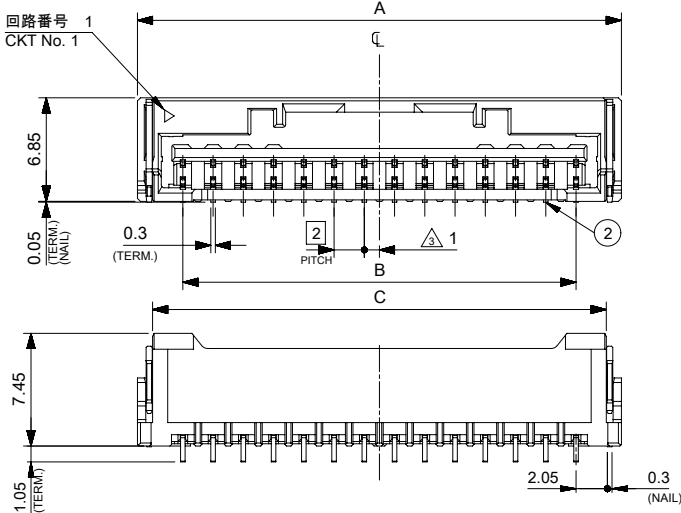
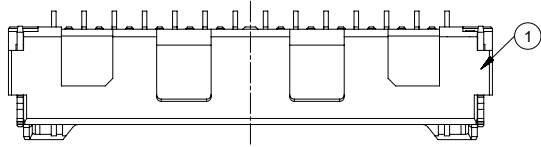

嵌合図 MATED CONNECTOR
(SCALE : 2:1)

9.2	32	28	34	502494-1570	15
5.2	30	26	32	502494-1470	14
5.2	28	24	30	502494-1370	13
5.2	26	22	28	502494-1270	12
5.2	22	18	24	502494-1070	10
5.2	18	14	20	502494-0870	8
4	14	10	16	502494-0670	6
7.6	10	6	12	502494-0470	4
4.8	8	4	10	502494-0370	3
2.8	6	2	8	502494-0270	2
D	C	B	A	EMBOSSED TAPE PACKAGE. 注文番号 ORDER NO.	種数 CKT.NO.

番号 NO.	部品 PART	材質 MATERIAL
①	ハウジング HOUSING	耐熱性樹脂 UL94V-0 色: ナチュラル HEATPROOF RESIN UL94V-0 COLOR:NATURAL
②	ターミナル TERMINAL	銅合金 COPPER ALLOY 錫めつき : 1.0 micro-meter MIN. TIN (TAIL AREA) ニッケルめつき(下地) : 1.0micro-meter MIN. NICKEL (UNDER PLATING)
③	ネイル NAIL	銅合金 COPPER ALLOY 錫めつき : 1.0 micro-meter MIN. TIN ニッケルめつき(下地) : 1.0micro-meter MIN. NICKEL (UNDER PLATING)
RELEASE STATUS P1 RELEASE DATE 12.07.2016 06:58:54		

THIS DRAWING CONTAINS INFORMATION THAT IS PROPRIETARY TO MOLEX ELECTRONIC TECHNOLOGIES, LLC AND SHOULD NOT BE USED WITHOUT WRITTEN PERMISSION

REVISED EC NO. 108544 DRWN: QHE31 CHKD: SAKAYAMA APPR: TKANEKO REV: 2016/07/12 2016/07/12 2016/07/12	GENERAL TOLERANCES (UNLESS SPECIFIED)	DIMENSION UNITS	SCALE	 CLIK-MATE 2.0MM PITCH WB CONN. RA TYPE REC. ASSY 2-15CKT PRODUCT CUSTOMER DRAWING
	ANGULAR TOL ± 3.0 °	MM	4:1	
	4 PLACES ± 0.2	DRWN BY	DATE	
	3 PLACES ± 0.2	AISHIKAWA	2016/04/19	
	2 PLACES ± 0.2	CHKD BY	DATE	
	1 PLACE ± 0.2	KOMURAKAMI	2016/04/28	
	0 PLACES ± 0.2	APPR BY	DATE	
		TKANEKO	2016/04/28	
	DRAFT WHERE APPLICABLE MUST REMAIN WITHIN DIMENSIONS	DRAWING SIZE	THIRD ANGLE PROJECTION	
B	A3			
DOCUMENT NUMBER		DOC TYPE	DOC PART	SHEET NUMBER
5024941509		PSD	000	1 OF 2

Contact us: sales@integrated-circuit.com Website: www.integrated-circuit.com

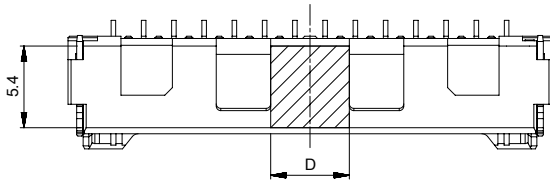

吸着エリア 6~15極
VACUME AREA 6~15CKT

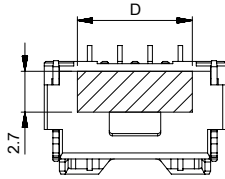

吸着エリア 2~4極
VACUME AREA 2~4CKT

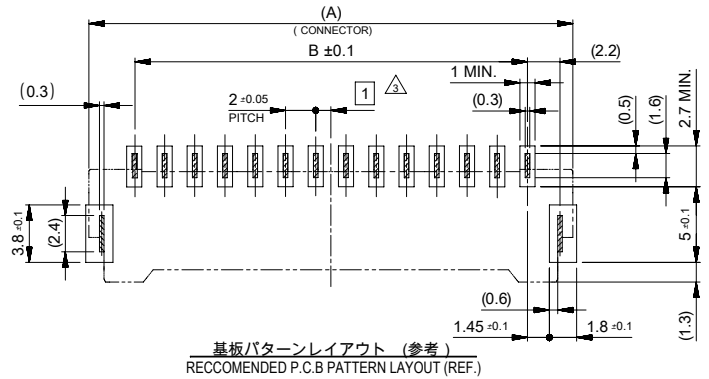

THIS DRAWING CONTAINS INFORMATION THAT IS PROPRIETARY TO MOLEX ELECTRONIC TECHNOLOGIES, LLC AND SHOULD NOT BE USED WITHOUT WRITTEN PERMISSION

EC NO. 106544 DRWN. QHE31 CHKD. SAKAYAMA APPR. TKANEKO REV.	GENERAL TOLERANCES (UNLESS SPECIFIED) ANGULAR TOL ± 3.0 °	DIMENSION UNITS: MM SCALE: 4:1				
	4 PLACES ± 0.2 3 PLACES ± 0.2 2 PLACES ± 0.2 1 PLACE ± 0.2 0 PLACES ± 0.2	DRWN BY: AISHIKAWA DATE: 2016/04/19 CHKD BY: KOMURAKAMI DATE: 2016/04/28 APPR BY: TKANEKO DATE: 2016/04/28				CLIK-MATE 2.0MM PITCH WB CONN. RA TYPE REC. ASSY 2-15CKT
	DRAFT WHERE APPLICABLE MUST REMAIN WITHIN DIMENSIONS	DRAWING SIZE: A3 THIRD ANGLE PROJECTION	SERIES: 502494 MATERIAL NUMBER: SEE TABLE CUSTOMER: GENERAL	PRODUCT CUSTOMER DRAWING		
	B	DOCUMENT NUMBER: 5024941509 DOC TYPE: PSD DOC PART: 000 SHEET NUMBER: 2 OF 2				

RELEASE STATUS	P1	RELEASE DATE	12.07.2016	06:58:54
----------------	----	--------------	------------	----------

Contact us: sales@integrated-circuit.com Website: www.integrated-circuit.com

