

Excellent Integrated System Limited

Stocking Distributor

Click to view price, real time Inventory, Delivery & Lifecycle Information:

[Molex Connector Corporation](#)
[0675810010](#)

For any questions, you can email us directly:
sales@integrated-circuit.com

10 9 8 7 6 5 4 3 2 1

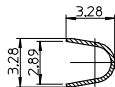
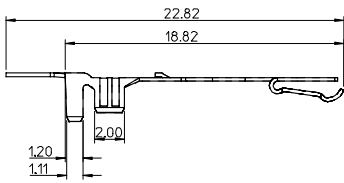

Section I-I

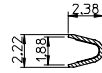

Section C-C

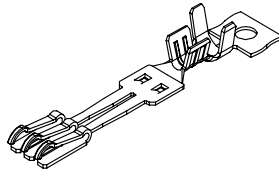
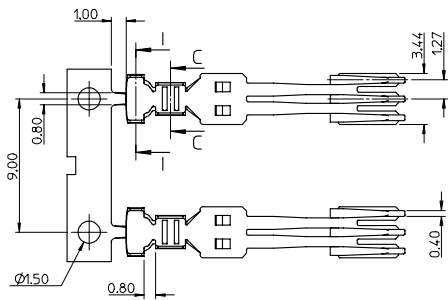

NOTES:

1. MATERIAL :
PHOSPHOR BRONZE, THICKNESS = 0.25mm
2. PLATING :
CONTACT AREA: (A) GOLD FLASH
(B) GOLD PLATED 0.76 MICRON,
(C) GOLD PLATED 0.38 MICRON.
CRIMPING AREA: TIN PLATED 1.875 MICRON MINIMUM.
UNDER PLATE: NICKELPLATED 1.25 MICRON MINIMUM.
3. TO BE USED WITH 67582, 5 SETS TERMINAL PER HOUSING
4. PRODUCT SPECIFICATION REFER TO PS-67490-002
5. PACKAGE SPECIFICATION REFER TO PK-67581-001
6. CRIMPING SPECIFICATION REFER TO CS-67581-001
7. RECOMMEND WIRE SIZE: 18/20/22AWG
8. PRODUCT COMPLIANT TO RoHS DIRECTIVE 2002/95/EC AND ELV DIRECTIVE 2000/53/EC.

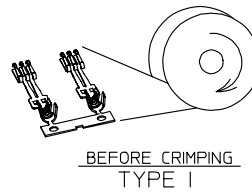

BEFORE CRIMPING
TYPE I

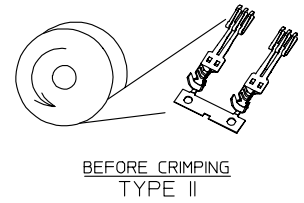

BEFORE CRIMPING
TYPE II

P/N	CONTACT AREA GOLD PLATING	TYPE
67581-0000	GOLD FLASH	TYPE I
67581-0001	0.76 MICRON GOLD PLATING	
67581-0002	0.38 MICRON GOLD PLATING	
67581-0010	GOLD FLASH	TYPE II
67581-0011	0.76 MICRON GOLD PLATING	
67581-0012	0.38 MICRON GOLD PLATING	

NEW RELEASE EC NO: SH2007-0312 DRAWN: BHE026 CHKD: JIAN APPR: JICHEN	QUALITY SYMBOLS ▽=0 ▽=0	GENERAL TOLERANCES (UNLESS SPECIFIED)		DIMENSION STYLE MM ONLY		SCALE 4:1	DESIGN UNITS METRIC	THIRD ANGLE PROJECTION	
		4 PLACES	± ---	± ---	DRAWN BY GRATE MA	DATE 2003/08/15	TITLE TERMINAL FOR SATA POWER CABLE RECEPTACLE MOLEX INCORPORATED MATERIAL NO. SEE TABLE DOCUMENT NO. SD-67581-001 SHEET NO. 1 OF 1		
		3 PLACES	± ---	± ---	CHECKED BY YA JUN	DATE 2003/08/15			
		2 PLACES	± 0.25	± 0.10	APPROVED BY SAM	DATE 2003/08/15			
1 PLACE	± 0.25	± 0.10							
		ANGULAR ± 3 °		DRAFT WHERE APPLICABLE MUST REMAIN WITHIN DIMENSIONS					

9 8 7 6 5 4 3 2 1