

Excellent Integrated System Limited

Stocking Distributor

Click to view price, real time Inventory, Delivery & Lifecycle Information:

[Molex Connector Corporation](#)
[0019092151](#)

For any questions, you can email us directly:

sales@integrated-circuit.com

PLUG

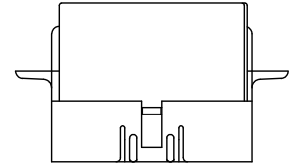
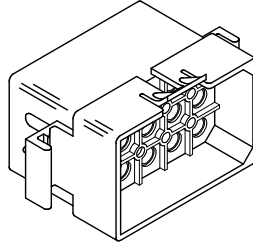
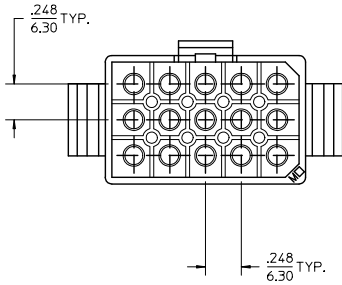
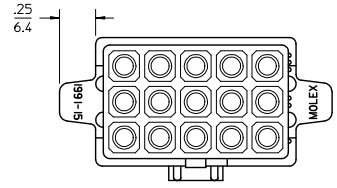
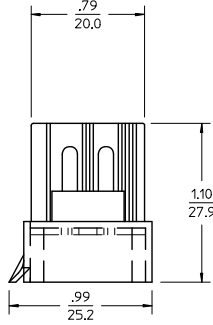
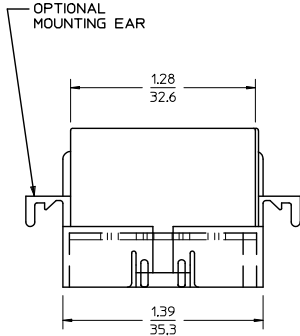
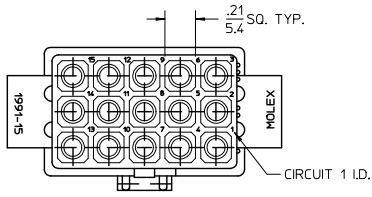

OPTIONAL PULL TAB
1991-15P SHOWN

ADD PULL TAB VIEWS EC NO: UCP2014-3949 DRAWN BY: 2014/04/17 CHKD BY: CHKOBANDERSON 2014/04/17 APPROV BY: APPROV SMITH 2014/06/10 REV:	QUALITY SYMBOLS □=0 □=0 □=0	GENERAL TOLERANCES (UNLESS SPECIFIED)		DIMENSION STYLE IN/MM		SCALE 2:1	DESIGN UNITS INCH	THIRD ANGLE PROJECTION		
		4 PLACES ± .005 ± .002	3 PLACES ± .005 ± .010	2 PLACES ± 0.25 ± .014	1 PLACE ± 0.35 ± .014	0 PLACE ± .005 ± .014	DRAWN BY: KBW DATE: 1989/04/25	TITLE .093/(2.36) HOUSINGS, PLUG AND RECEPTACLE, 15 CKT .248/(6.30) CTRS.		
		ANGULAR ± 1/2°					CHECKED BY: RW DATE: 1989/04/25	molex		
		DRAFT WHERE APPLICABLE MUST REMAIN WITHIN DIMENSIONS					APPROVED BY: F SMITH DATE: 2014/06/10	MATERIAL NO. SEE CHART	DOCUMENT NO. SD-1991-15*	SHEET NO. 1 OF 3

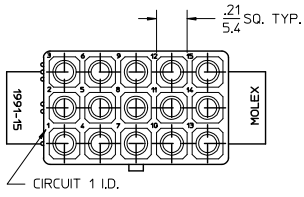

RECEPTACLE

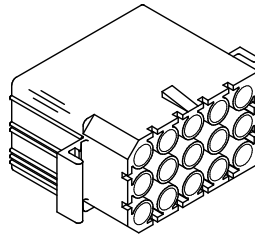
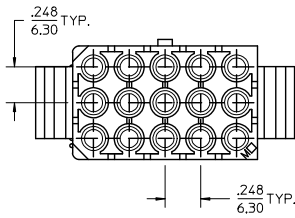
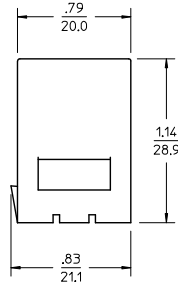
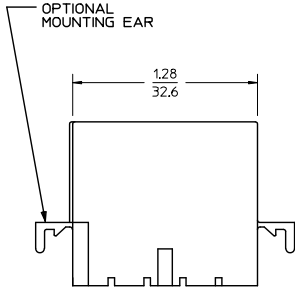

SEE SHEET 1 EC NO: UCP2014-3949 DRAWN BY: ZHANGTIPPER CHECKED BY: CHIKOBANDERSON APPROVED BY: APPRECI SMITH	QUALITY SYMBOLS □=0 □=0 □=0	GENERAL TOLERANCES (UNLESS SPECIFIED)		DIMENSION STYLE IN/MM		SCALE 2:1	DESIGN UNITS INCH	THIRD ANGLE PROJECTION
		4 PLACES ± --- ± --- 3 PLACES ± --- ± .010 2 PLACES ± 0.25 ± .014 1 PLACE ± 0.35 ± --- 0 PLACE ± --- ± ---	mm INCH DRAWN BY: KBW CHECKED BY: RW APPROVED BY: F SMITH DATE: 1989/04/25 DATE: 1989/04/25 DATE: 2014/06/10	TITLE .093/(2.36) HOUSINGS, PLUG AND RECEPTACLE, 15 CKT .248/(6.30) CTRS.			MATERIAL NO. SEE CHART	DOCUMENT NO. SD-1991-15*
DRAFT WHERE APPLICABLE MUST REMAIN WITHIN DIMENSIONS		THIS DRAWING CONTAINS INFORMATION THAT IS PROPRIETARY TO MOLEX INCORPORATED AND SHOULD NOT BE USED WITHOUT WRITTEN PERMISSION						

PLUG		
ORDER NO	ENG NO	PKG. INFORMATION
19-09-2151	1991-15P	PK-1991-002
19-09-2153	1991-15P2	PK-1991-002
19-09-7151	1991-15PBK	PK-1991-001
-	-	-
-	-	-

RECEPTACLE		
ORDER NO	ENG NO	PKG. INFORMATION
19-09-1151	1991-15R2	PK-1991-002
19-09-1152	1991-15R1	PK-1991-002
19-09-6151	1991-15R2BK	PK-1991-001
19-09-6152	1991-15R1BK	PK-1991-001
-	-	-
-	-	-

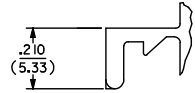
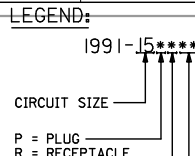

DETAIL A
STANDARD MOUNTING EAR
(SCALE 4:1)

BLANK = WITH PULL TABS
1 = WITHOUT EARS/WITHOUT PULL TABS
2 = WITH STANDARD EARS
3 = WITH PREBENT EARS

COLOR:

BLANK = NATURAL COLOR
AM = AMBER BK = BLACK BU = BLUE
BN = BROWN GY = GRAY GN = GREEN
OR = ORANGE RD = RED YW = YELLOW

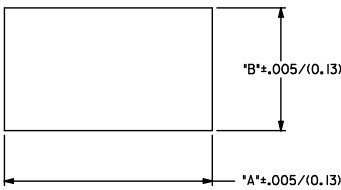
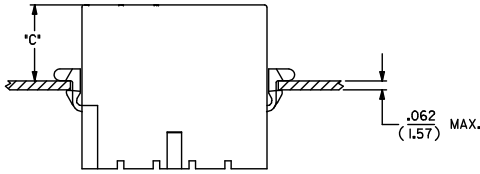

RECOMMENDED PANEL OPENING

HOUSING	DIM. "A"	DIM. "B"	"C" PREBENT EAR	"C" STANDARD EAR
PLUG	1.552/(39.42)	.910/(23.11)	.31/(7.9)	.30/(7.6)
RECEPT.	1.442/(36.63)	.850/(21.60)	.54/(13.7)	.53/(13.5)

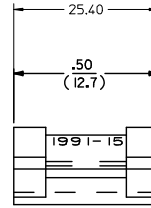

DETAIL B
PREBENT MOUNTING EAR
(SCALE 4:1)

- NOTES:**
- MATERIAL: NYLON TYPE 6/6, 94V-2.
 - FINISH: N/A
 - PRODUCT SPECIFICATION: PS-02-09
 - PACKAGING SPECIFICATION: SEE CHART
 - HOUSINGS FOR USE WITH MOLEX STANDARD .093/(2.36) TYPE TERMINALS
 - PARTS CONFORM TO CLASS B REQUIREMENTS OF COSMETIC SPECIFICATION PS-45499-002.

SEE SHEET 1 IEC NO: UCP2014-3949 DRAWN BY: 2014/04/17 CHKD BY: 2014/04/17 APPROVED BY: 2014/06/10	QUALITY SYMBOLS ∇=0 ∇=0 ∇=0	GENERAL TOLERANCES (UNLESS SPECIFIED)		DIMENSION STYLE IN/MM		SCALE 2:1	DESIGN UNITS INCH	THIRD ANGLE PROJECTION	
		4 PLACES ± --- ± ---	3 PLACES ± --- ± .010	DRAWN BY: KBW	DATE: 1989/04/25	TITLE: .093/(2.36) HOUSINGS, PLUG AND RECEPTACLE, 15 CKT .248/(6.30) CTRS. molex MATERIAL NO. SD-1991-15* DOCUMENT NO.			
		2 PLACES ± 0.25 ± .014	1 PLACE ± 0.35 ± ---	CHECKED BY: RW	DATE: 1989/04/25				
		0 PLACE ± --- ± ---	ANGULAR ± 1/2°	APPROVED BY: F SMITH	DATE: 2014/06/10				
DRAFT WHERE APPLICABLE MUST REMAIN WITHIN DIMENSIONS		SEE CHART		SHEET NO. 3 OF 3					