

## Excellent Integrated System Limited

Stocking Distributor

Click to view price, real time Inventory, Delivery & Lifecycle Information:

[IXYS Corporation](#)  
[CS23-08IO2](#)

For any questions, you can email us directly:  
[sales@integrated-circuit.com](mailto:sales@integrated-circuit.com)

**IXYS** **CS 23**

# Phase Control Thyristors

**$V_{RRM} = 800-1600\text{ V}$**   
 **$I_{T(RMS)} = 50\text{ A}$**   
 **$I_{T(AV)M} = 32\text{ A}$**

$V_{RSM}$ $V_{DSM}$ V	$V_{RRM}$ $V_{DRM}$ V	Type
900	800	CS 23-08io2
1300	1200	CS 23-12io2
1700	1600	CS 23-16io2

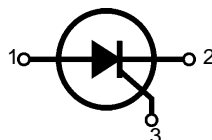

TO-208AA  
(TO-48)

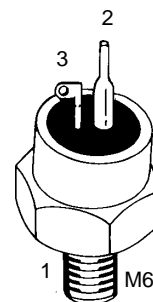

1 = Anode, 2 = Cathode, 3 = Gate

Symbol	Test Conditions	Maximum Ratings
$I_{T(RMS)}$	$T_{VJ} = T_{VJM}$	50 A
$I_{T(AV)M}$	$T_{case} = 85^{\circ}\text{C}; 180^{\circ}\text{ sine}$ $T_{case} = 69^{\circ}\text{C}; 180^{\circ}\text{ sine}$	25 A 32 A
$I_{TSM}$	$T_{VJ} = 45^{\circ}\text{C}; V_R = 0$	t = 10 ms (50 Hz), sine 450 A
		t = 8.3 ms (60 Hz), sine 480 A
	$T_{VJ} = T_{VJM}; V_R = 0$	t = 10 ms (50 Hz), sine 400 A
		t = 8.3 ms (60 Hz), sine 430 A
$I^2t$	$T_{VJ} = 45^{\circ}\text{C}; V_R = 0$	t = 10 ms (50 Hz), sine 1010 A <sup>2</sup> s
		t = 8.3 ms (60 Hz), sine 970 A <sup>2</sup> s
	$T_{VJ} = T_{VJM}; V_R = 0$	t = 10 ms (50 Hz), sine 800 A <sup>2</sup> s
		t = 8.3 ms (60 Hz), sine 770 A <sup>2</sup> s
$(di/dt)_{cr}$	$T_{VJ} = T_{VJM}; f = 50\text{ Hz}; t_p = 200\text{ }\mu\text{s}; V_D = 2/3 V_{DRM}; I_G = 0.3\text{ A}; di_G/dt = 0.3\text{ A}/\mu\text{s}$	repetitive, $I_T = 75\text{ A}$ 150 A/ $\mu\text{s}$
		non repetitive, $I_T = I_{T(AV)M}$ 500 A/ $\mu\text{s}$
$(dv/dt)_{cr}$	$T_{VJ} = T_{VJM}; R_{GK} = \infty; \text{method 1 (linear voltage rise)}$	1000 V/ $\mu\text{s}$
$P_{GM}$	$T_{VJ} = T_{VJM}; I_T = I_{T(AV)M}$	$t_p = 30\text{ }\mu\text{s}$ 10 W
		$t_p = 300\text{ }\mu\text{s}$ 5 W
$P_{G(AV)}$		0.5 W
$V_{RGM}$		10 V
$T_{VJ}$		-40...+125 °C
$T_{VJM}$		125 °C
$T_{stg}$		-40...+125 °C
$M_d$	Mounting torque	2.7-3.3 Nm
		24-29 lb.in.
Weight		12 g

### Features

- Thyristor for line frequencies
- International standard package JEDEC TO-208AA
- Planar glassivated chip
- Long-term stability of blocking currents and voltages

### Applications

- Motor control
- Power converter
- AC power controller

### Advantages

- Space and weight savings
- Simple mounting
- Improved temperature and power cycling

### Dimensions in mm (1 mm = 0.0394")

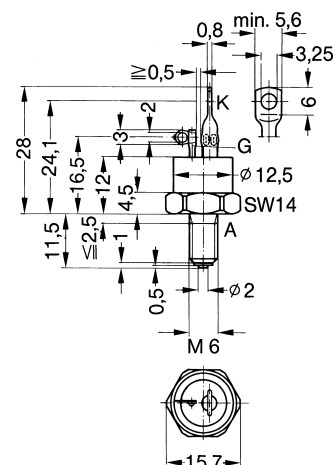

Data according to IEC 60747  
 IXYS reserves the right to change limits, test conditions and dimensions

**IXYS** **CS 23**

Symbol	Test Conditions	Characteristic Values	
$I_R, I_D$	$T_{VJ} = T_{VJM}; V_R = V_{RRM}; V_D = V_{DRM}$	$\leq$	3 mA
$V_T$	$I_T = 80 \text{ A}; T_{VJ} = 25^\circ\text{C}$	$\leq$	1.8 V
$V_{T0}$	For power-loss calculations only ( $T_{VJ} = 125^\circ\text{C}$ )		1.0 V
$r_T$			10 mΩ
$V_{GT}$	$V_D = 6 \text{ V}; T_{VJ} = 25^\circ\text{C}$	$\leq$	2.5 V
	$T_{VJ} = -40^\circ\text{C}$	$\leq$	3.5 V
$I_{GT}$	$V_D = 6 \text{ V}; T_{VJ} = 25^\circ\text{C}$	$\leq$	50 mA
	$T_{VJ} = -40^\circ\text{C}$	$\leq$	80 mA
$V_{GD}$	$T_{VJ} = T_{VJM}; V_D = 2/3 V_{DRM}$	$\leq$	0.2 V
$I_{GD}$		$\leq$	1 mA
$I_L$	$T_{VJ} = 25^\circ\text{C}; t_p = 10 \mu\text{s}$ $I_G = 0.15 \text{ A}; di_G/dt = 0.15 \text{ A}/\mu\text{s}$	$\leq$	200 mA
$I_H$	$T_{VJ} = 25^\circ\text{C}; V_D = 6 \text{ V}; R_{GK} = \infty$	$\leq$	100 mA
$t_{gd}$	$T_{VJ} = 25^\circ\text{C}; V_D = 1/2 V_{DRM}$ $I_G = 0.15 \text{ A}; di_G/dt = 0.15 \text{ A}/\mu\text{s}$	$\leq$	2 μs
$t_q$	$T_{VJ} = T_{VJM}; I_T = 25 \text{ A}, t_p = 300 \mu\text{s}; di/dt = -20 \text{ A}/\mu\text{s}$ $V_R = 100 \text{ V}; dv/dt = 20 \text{ V}/\mu\text{s}; V_D = 2/3 V_{DRM}$	typ.	60 μs
$R_{thJC}$	DC current		1.0 K/W
$R_{thJH}$	DC current		1.61 K/W
$d_s$	Creepage distance on surface		1.5 mm
$d_A$	Strike distance through air		1.5 mm
$a$	Max. acceleration, 50 Hz		50 m/s <sup>2</sup>

Accessories:  
 Nut M6 DIN 439/SW14  
 Lock washer A6 DIN 128

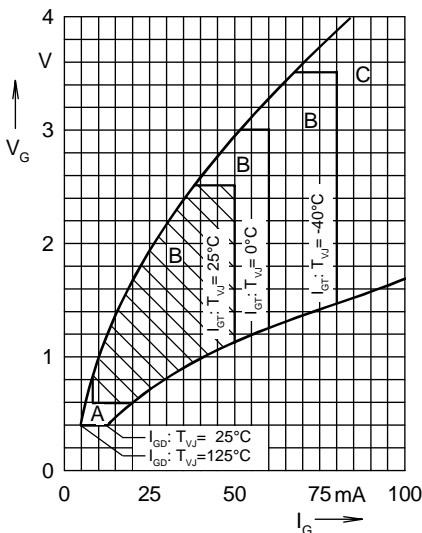

Fig. 1 Gate voltage and gate current  
 Triggering:  
 A = no; B = possible; C = safe

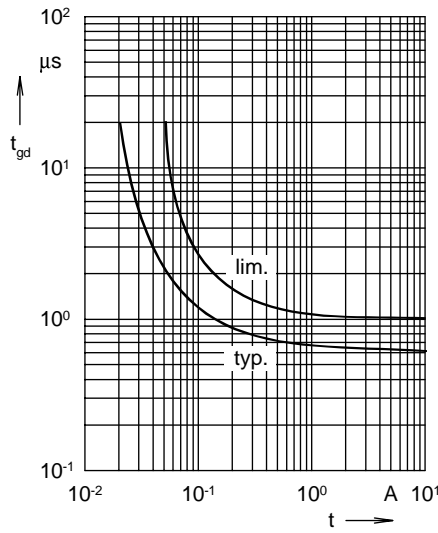

Fig. 2 Gate controlled delay time  $t_{gd}$

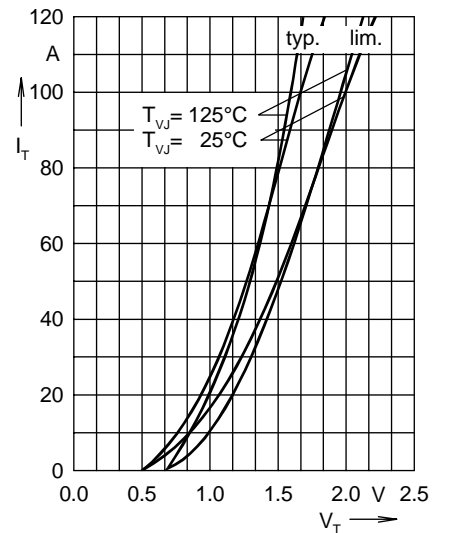

Fig. 3 On-state characteristics

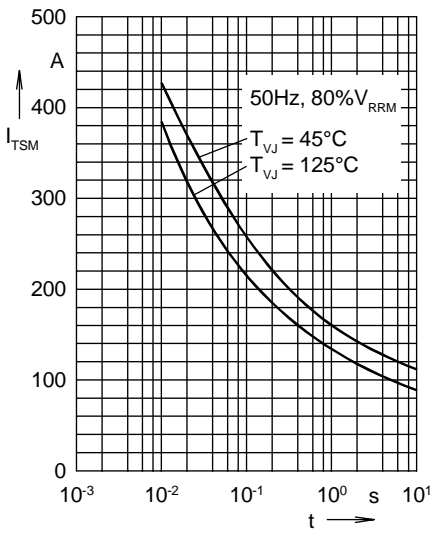

Fig. 4 Surge overload current  
 $I_{TSM}$ : crest value, t: duration

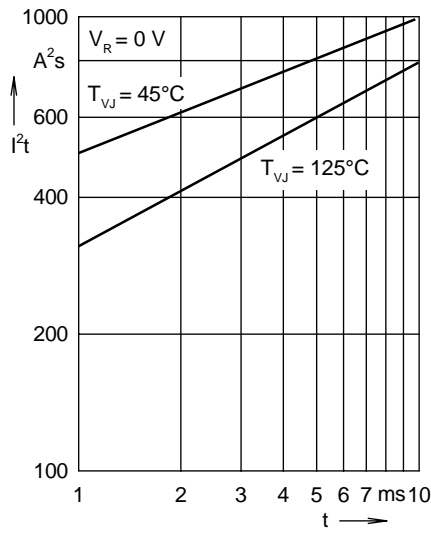

Fig. 5  $I^2t$  versus time (1-10 ms)

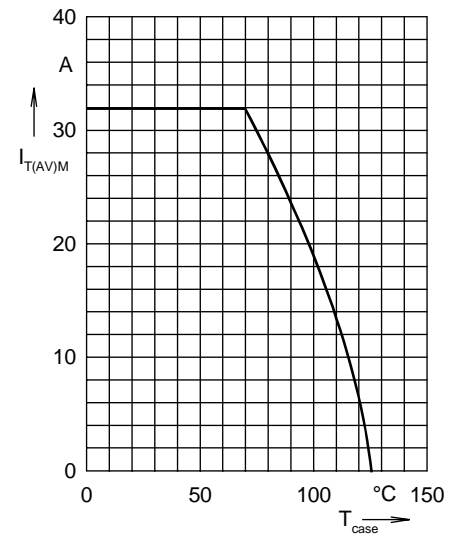

Fig. 6 Maximum forward current at case temperature 180° sine

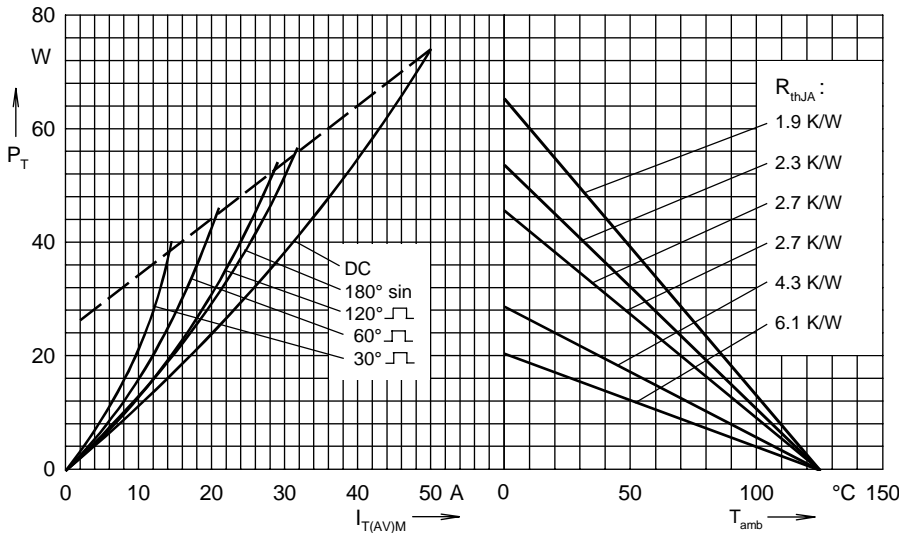

Fig. 7 Power dissipation versus on-state current and ambient temperature

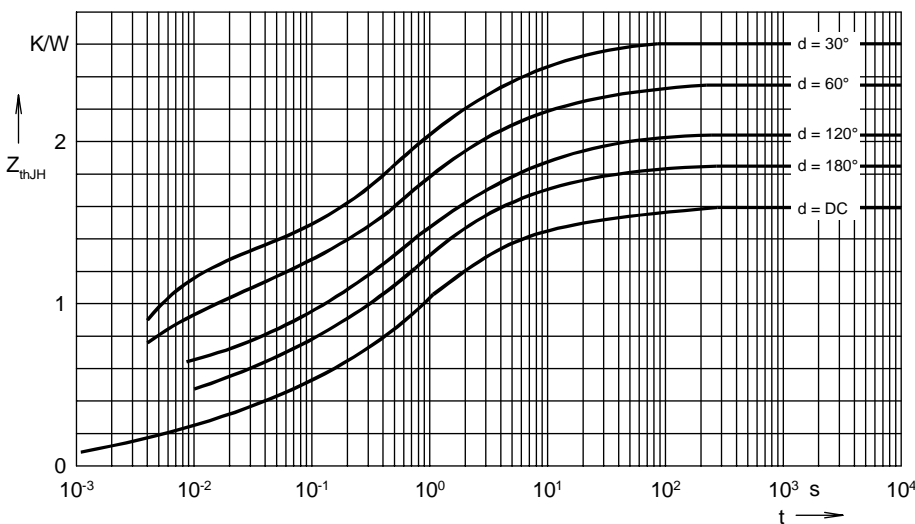

Fig. 8 Transient thermal impedance junction to heatsink

$R_{thJH}$  for various conduction angles d:

d	$R_{thJH}$ (K/W)
DC	1.61
180°	1.85
120°	2.03
60°	2.35
30°	2.60

Constants for  $Z_{thJH}$  calculation:

i	$R_{thi}$ (K/W)	$t_i$ (s)
1	0.224	0.003
2	0.132	0.028
3	0.321	0.216
4	0.522	1.1
5	0.249	4.2
6	0.162	43.2