

Excellent Integrated System Limited

Stocking Distributor

Click to view price, real time Inventory, Delivery & Lifecycle Information:

[Diodes Incorporated](#)
[ZRA245N801TA](#)

For any questions, you can email us directly:

sales@integrated-circuit.com

PRECISION 2.45 VOLT VOLTAGE REFERENCE

ZRA245

ISSUE 3 — MARCH 1998

DEVICE DESCRIPTION

The ZRA245 uses a bandgap circuit design to achieve a precision voltage reference of 2.45 volts. The device is available in small outline surface mount packages, ideal for applications where space saving is important.

The ZRA245 design provides a stable voltage without an external capacitor and is stable with capacitive loads. The ZRA245 is recommended for operation between 2mA and 120mA.

FEATURES

- Small outline SOT23, SO8 and TO92 style package
- No stabilising capacitor required
- Typical T_C 15ppm/°C
- Typical slope resistance 0.26Ω
- ± 3% , 2% and 1% tolerance
- Industrial temperature range
- Operating current 2mA to 120mA

APPLICATIONS

- Battery powered and portable equipment.
- Metering and measurement systems.
- Instrumentation.
- Test equipment.
- Data acquisition systems.
- Precision power supplies.

SCHEMATIC DIAGRAM

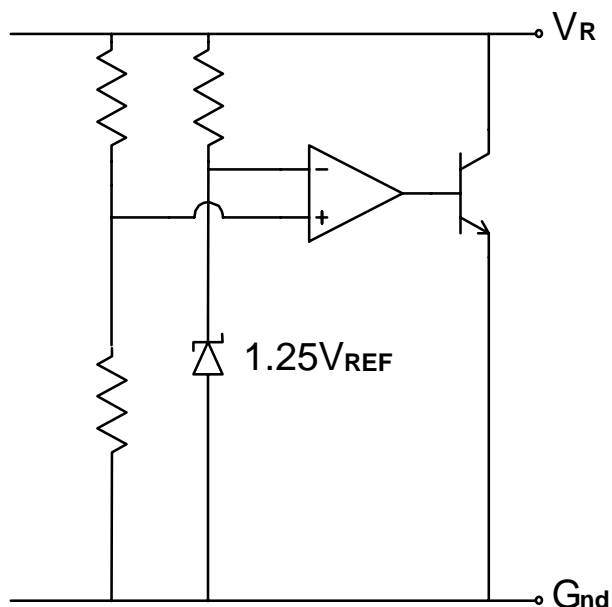

ZRA245

ABSOLUTE MAXIMUM RATING

Reverse Current	200mA
Forward Current	25mA
Operating Temperature	-40 to 85°C
Storage Temperature	-55 to 125°C

Power Dissipation (T_{amb}=25°C)

SOT23	330mW
E-Line, 3 pin (TO92)	500mW
E-Line, 2 pin (TO92)	500mW
SO8	625mW

ELECTRICAL CHARACTERISTICS

TEST CONDITIONS (Unless otherwise stated) T_{amb}=25°C

SYMBOL	PARAMETER	CONDITIONS	LIMITS			TOL. %	UNITS
			MIN	TYP	MAX		
V _R	Reverse Breakdown Voltage	I _R =5mA	2.43 2.40 2.38	2.45 2.45 2.45	2.47 2.50 2.52	1 2 3	V
I _{MIN}	Minimum Operating Current				2		mA
I _R	Recommended Operating Current		2		120		mA
T _C †	Average Reverse Breakdown Voltage Temp. Co.	I _{R(min)} to I _{R(max)}		15	50		ppm/°C
R _S §	Slope Resistance			0.26	0.5		Ω
Z _R	Reverse Dynamic Impedance	I _R = 5mA f = 100Hz I _{AC} =0.1 I _R		0.28	1		Ω
E _N	Wideband Noise Voltage	I _R = 5mA f = 10Hz to 10kHz		65			μV(rms)

$$\dagger T_C = \frac{(V_{R(max)} - V_{R(min)}) \times 1000000}{V_R \times (T_{(max)} - T_{(min)})}$$

Note: V_{R(max)} - V_{R(min)} is the maximum deviation in reference voltage measured over the full operating temperature range.

$$\S R_S = \frac{V_R \text{ Change}(I_R(\text{min}) \text{ to } I_R(\text{max}))}{I_R(\text{max}) - I_R(\text{min})}$$

ZRA245

TYPICAL CHARACTERISTICS

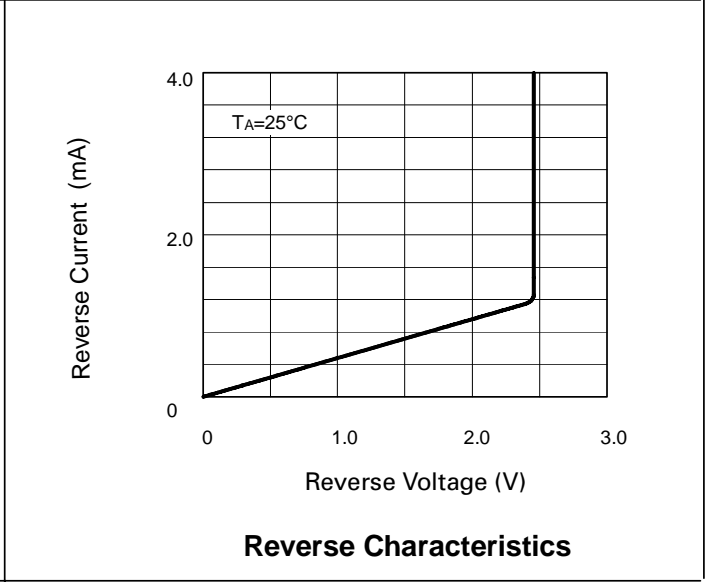
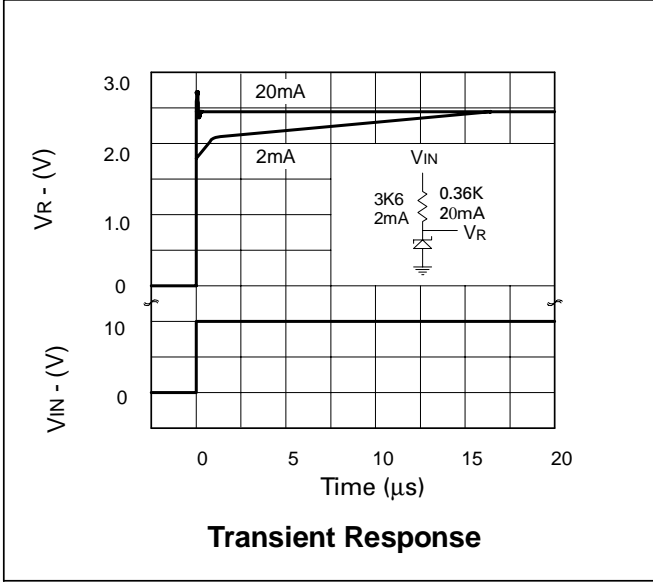
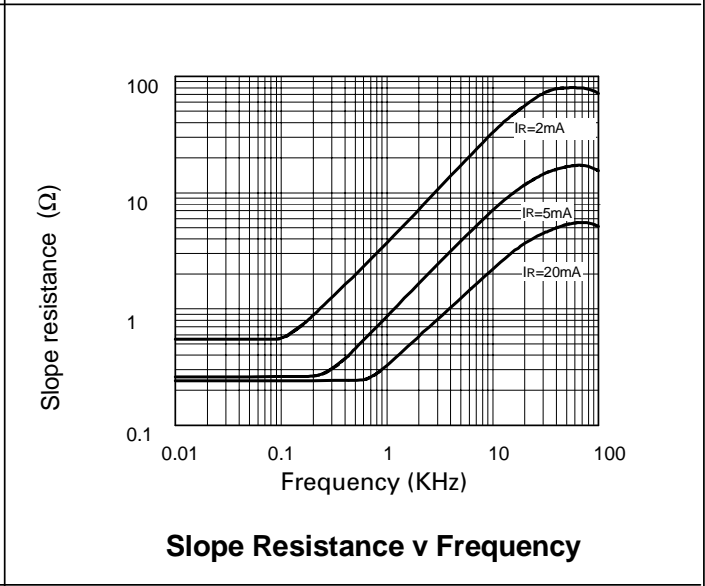
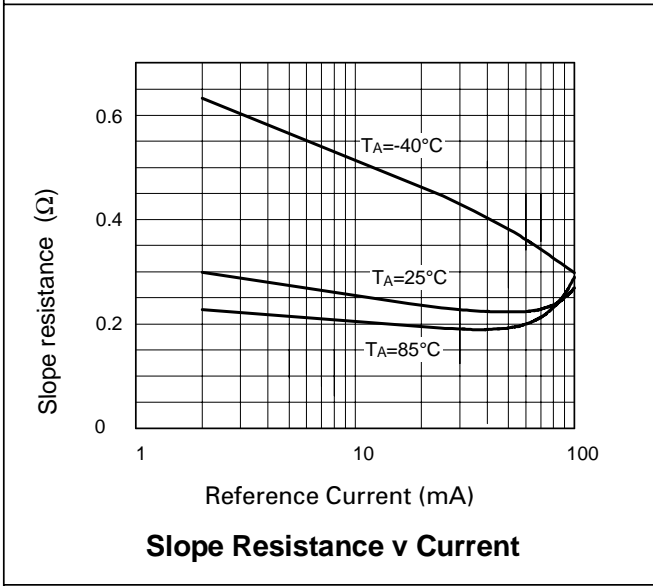
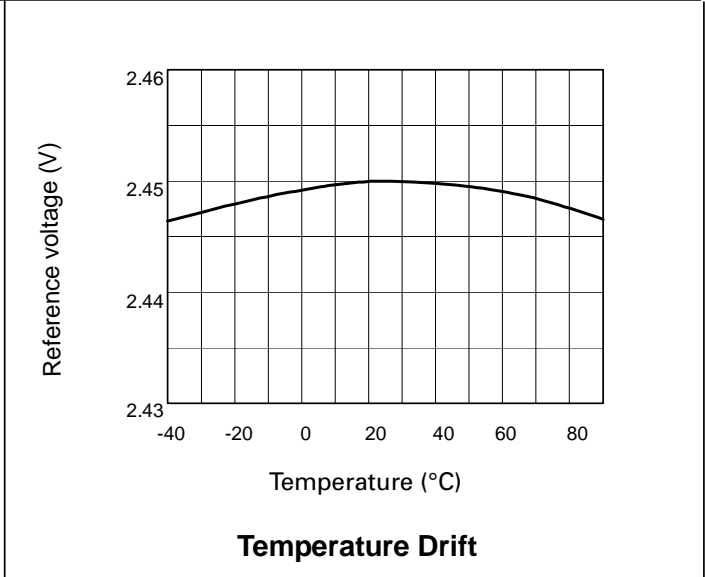
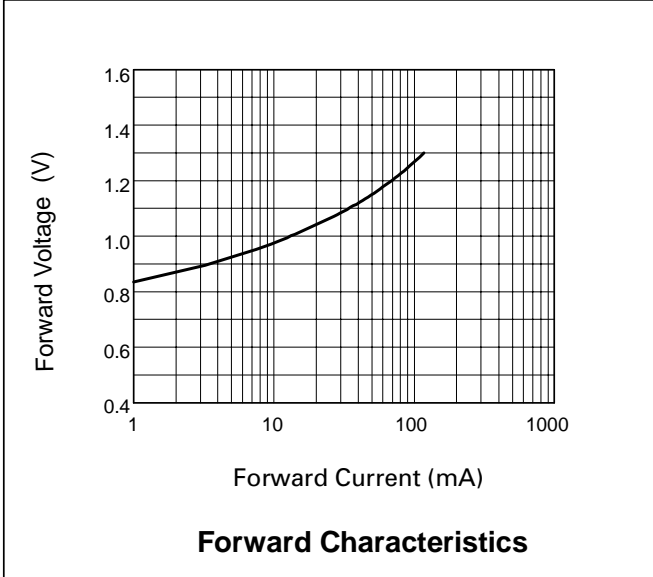

ZRA245

CONNECTION DIAGRAMS

E-Line, 2 pin Package Suffix - Y

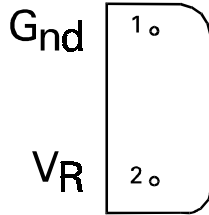

Bottom View

E-Line, 3 pin, Rev Package Suffix - R

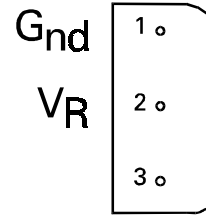

*Bottom View -
Pin 3 floating or connected to pin 1*

E-Line, 3 pin Package Suffix - A

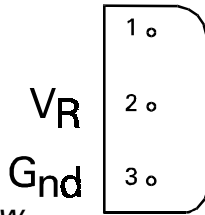

*Bottom View -
Pin 1 floating or connected to pin 3*

SO8 Package Suffix - N8

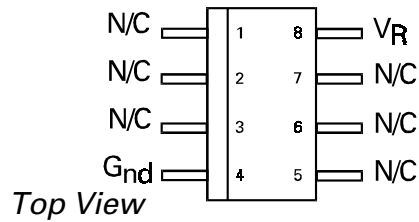

Top View

SOT23 Package Suffix - F

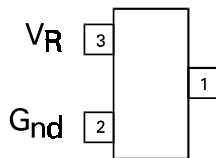

*Top View -
Pin 1 floating or connected to pin 2*

ZRA245

ORDERING INFORMATION

Part No	Tol%	Package	Partmark
ZRA245A03	3	E-Line •	ZRA24503
ZRA245A02	2	E-Line •	ZRA24502
ZRA245A01	1	E-Line •	ZRA24501
ZRA245F03	3	SOT23	24A
ZRA245F02	2	SOT23	24B
ZRA245F01	1	SOT23	24C
ZRA245N803	3	SO8	ZRA24503
ZRA245N802	2	SO8	ZRA24502
ZRA245N801	1	SO8	ZRA24501

Part No	Tol%	Package	Partmark
ZRA245R03	3	E-Line *	ZRA245R3
ZRA245R02	2	E-Line *	ZRA245R2
ZRA245R01	1	E-Line *	ZRA245R1
ZRA245Y03	3	E-Line †	ZRA24503
ZRA245Y02	2	E-Line †	ZRA24502
ZRA245Y01	1	E-Line †	ZRA24501

* E-Line 3 pin Reversed

† E-Line 2 pin

• E-Line 3 pin