



Excellent Integrated System Limited

Stocking Distributor

Click to view price, real time Inventory, Delivery & Lifecycle Information:

[ITT Cannon, LLC](#)
[CA3101E14S-7S](#)

For any questions, you can email us directly:

sales@integrated-circuit.com

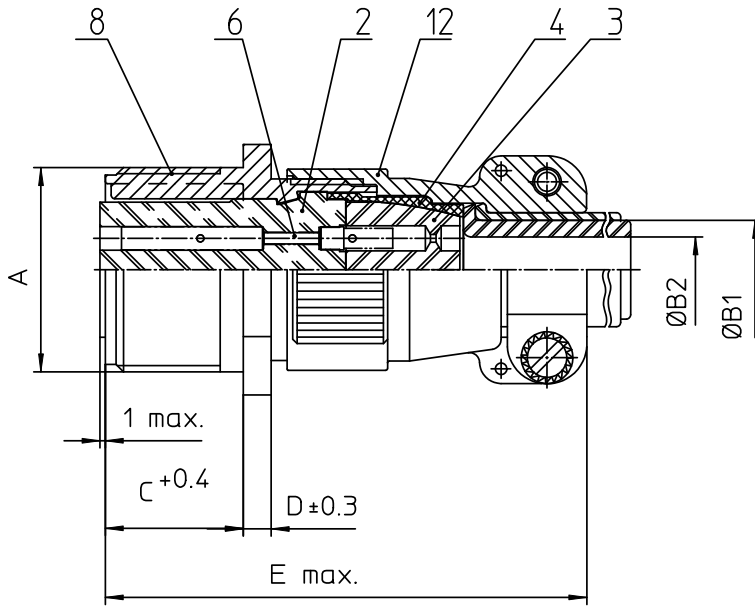

NO.	MASSE / DIMENSION
A	7/8-20UNEF-2A
B1	9.1
B2	-
C	14.2
D	3.2
E	55
F	28.2
G	22.5

NO.	BESCHREIBUNG / DESCRIPTION
2	ISOLIERKÖRPER BUCHSE / INSULATOR SOCKET
3	DICHTKÖRPER / GROMMET
4	ENDRING / ENDRING
6	KONTAKTBUCHSE / CONTACT SOCKET
8	DOSENGEHÄUSE / SHELL
12	ENDGEHÄUSE / ENDBELL

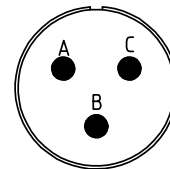

Note: Due to an automatic nomenclature system, numbers generated may not be sequential.
Specification and Dimensions subject to change
Drawings illustrate normal insulator positioning

Material Specification:	
Shell Material:	Aluminium alloy
Shell Plating:	Olive drab chromate coating over cadmium plating
Insulator Material:	Neoprene
Contact Material:	Copper alloy
Contact Plating:	Hard silver

all dimensions are in mm
Dimensions without tolerance indications are general tolerances in acc. with DIN7168m

drawing for
CUSTOMER



description CA3101E14S-7S
Cable connecting plug
Endbell with clamp and bushing
Solder Cup / Socket / Layout: 14S-7

© All rights reserved. Reproduction or use in third in any form
whenever is only permitted with written authorization of ITT Cannon



page 1/1
revision 377.3, Jul 16