



Excellent Integrated System Limited

Stocking Distributor

Click to view price, real time Inventory, Delivery & Lifecycle Information:

[ITT Cannon, LLC](#)
[CA06R14S-2SF80](#)

For any questions, you can email us directly:

sales@integrated-circuit.com

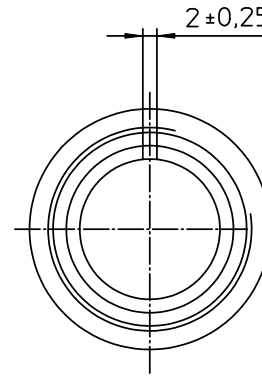
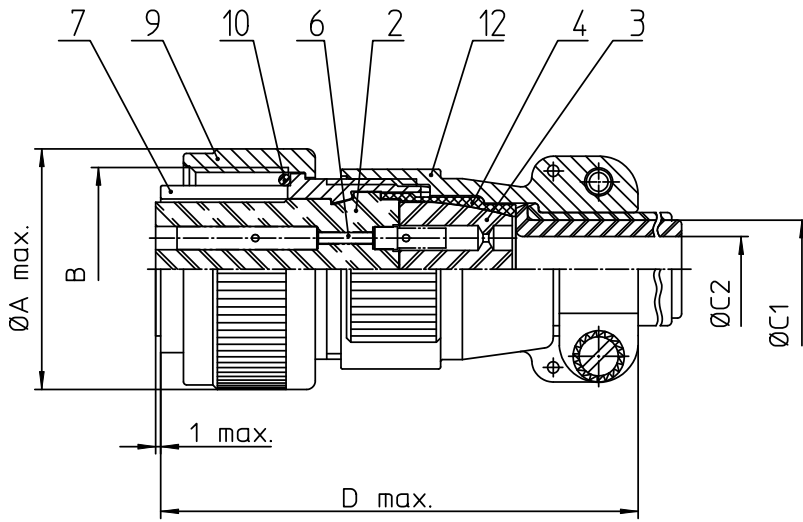

NO.	MASSE / DIMENSION
A	28.8
B	7/8-20UNEF-2B
C1	9.1
C2	-
D	55

NO.	BESCHREIBUNG / DESCRIPTION
2	ISOLIERKÖRPER BUCHSE / INSULATOR SOCKET
3	DICHTKÖRPER / GROMMET
4	ENDRING / ENDRING
6	KONTAKTBÜCHSE / CONTACT SOCKET
7	ZYLINDERGHÄUSE / BARREL
9	ÜBERWURFMUTTER / COUPLING NUT
10	DICHTRING FRONT / FRONT SEALING RING
12	ENDGEHÄUSE / ENDBELL

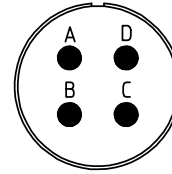

Note: Due to an automatic nomenclature system, numbers generated may not be sequential.
Specification and Dimensions subject to change
Drawings illustrate normal insulator positioning

Material Specification:	
Shell Material:	Aluminium alloy
Shell Plating:	Olive drab chromate coating over cadmium plating
Insulator Material:	Neoprene
Contact Material:	Copper alloy
Contact Plating:	Hard silver

all dimensions are in mm Dimensions without tolerance indications are general tolerances in acc. with DIN7168m		drawing for CUSTOMER
 ITT Engineered for life <small>ITT CANNON GmbH D-37189 Verden/Leine, Germany</small>	description CA06R14S-2S-F80 Plug, straight Endbell with cable clamp AWG Crimp / Socket / Layout: 14S-2	
	<small>© All rights reserved. Reproduction or issue in third in any form whenever is only permitted with written authorization of ITT Cannon</small>	page 1/1 revision 377.3, Jul 16