



Excellent Integrated System Limited

Stocking Distributor

Click to view price, real time Inventory, Delivery & Lifecycle Information:

[ITT Cannon, LLC](#)
[CA3102E20-27PB109](#)

For any questions, you can email us directly:
sales@integrated-circuit.com

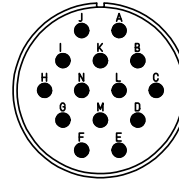
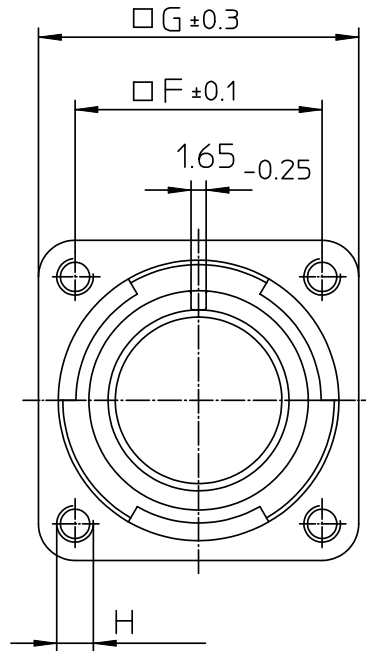
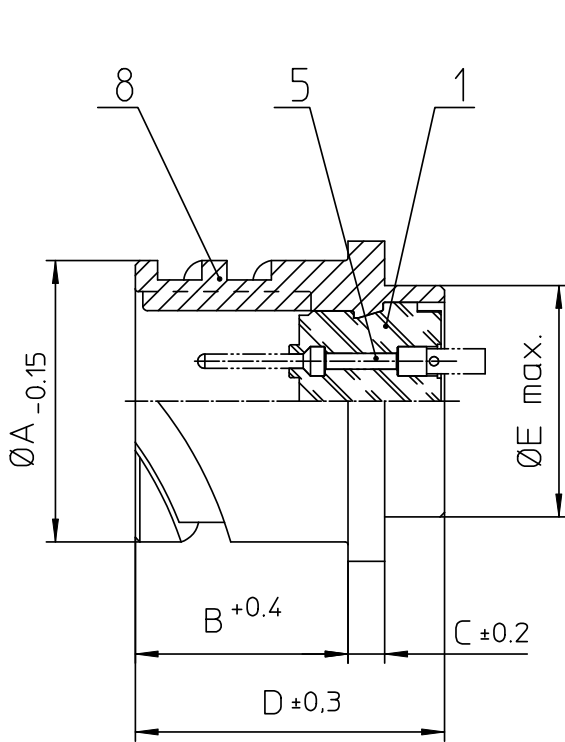

NO.	MASSE / DIMENSION
A	34.2
B	23.05
C	4
D	33.8
E	29
F	29.4
G	38
H	M4

NO.	BESCHREIBUNG / DESCRIPTION
1	ISOLIERKÖRPER STIFT / INSULATOR PIN
5	KONTAKTSTIFT/ CONTACT PIN
8	DOSENGEHÄUSE / SHELL

Note: Due to an automatic nomenclature system, numbers generated may not be sequential.
Specification and Dimensions subject to change
Drawings illustrate normal insulator positioning

Material Specification:	
Shell Material:	Aluminium alloy
Shell Plating:	Olive drab chromate over cadmium (conductive)
Insulator Material:	CR-Elastomere
Contact Material:	Copper alloy
Contact Plating:	Hard silver

all dimensions are in mm
Dimensions without tolerance indications are general tolerances in acc. with DIN7168m

drawing for
CUSTOMER

ITT
Engineered for life
ITT CANNON GmbH
D-73239 Heimenkirch/Germany

description CA3102E20-27P-B-109
Box mounting receptacle (rear mount, threaded holes)

AWG Crimp / Pin / Layout: 20-27

© All rights reserved. Reproduction or issue to third in any form
whenever is only permitted with written authorization of ITT Cannon

page 1/1
revision 786 4. Jul 16