



Excellent Integrated System Limited

Stocking Distributor

Click to view price, real time Inventory, Delivery & Lifecycle Information:

[ITT Cannon, LLC](#)
[CA3106F18-12SF80](#)

For any questions, you can email us directly:

sales@integrated-circuit.com

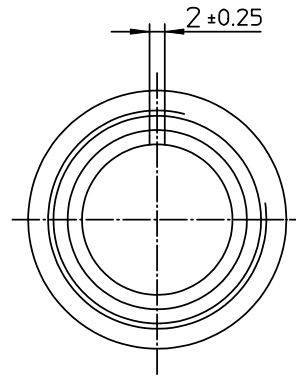
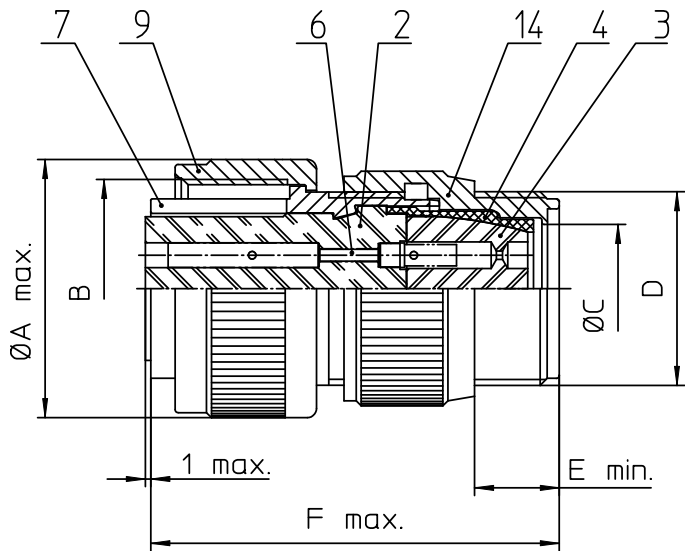

NO.	MASSE / DIMENSION
A	34.1
B	1 1/8-18NEF-2B
C	16.7
D	1-20UNEF-2A
E	9.5
F	54

NO.	BESCHREIBUNG / DESCRIPTION
2	ISOLIERKÖRPER BUCHSE / INSULATOR SOCKET
3	DICHTKÖRPER / GROMMET
4	ENDRING / ENDRING
6	KONTAKTBUCHSE / CONTACT SOCKET
7	ZYLINDERGHÄUSE / BARREL
9	ÜBERWURFMUTTER / COUPLING NUT
14	F-ENDGEHÄUSE / F-ENDBELL

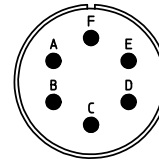

Note: Due to an automatic nomenclature system, numbers generated may not be sequential.
 Specification and Dimensions subject to change
 Drawings illustrate normal insulator positioning

Material Specification:	
Shell Material:	Aluminium alloy
Shell Plating:	Olive drab chromate coating over cadmium plating
Insulator Material:	Neoprene
Contact Material:	Copper alloy
Contact Plating:	Hard silver

all dimensions are in mm
 Dimensions without tolerance indications are general tolerances in acc. with DIN7168m

drawing for
 CUSTOMER



description CA3106F18-12S-F80
 Plug, straight
 Endbell for flex tube
 AWG Crimp / Socket / Layout: 18-12

© All rights reserved. Reproduction or use in third in any form
 whatever is only permitted with written authorization of ITT Cannon

page 1/1 revision 377.3. Jul 16