



Excellent Integrated System Limited

Stocking Distributor

Click to view price, real time Inventory, Delivery & Lifecycle Information:

[ITT Cannon, LLC](#)
[CA3102E28-19SF80](#)

For any questions, you can email us directly:

sales@integrated-circuit.com

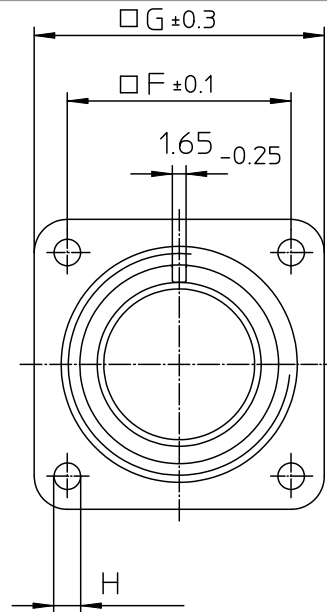
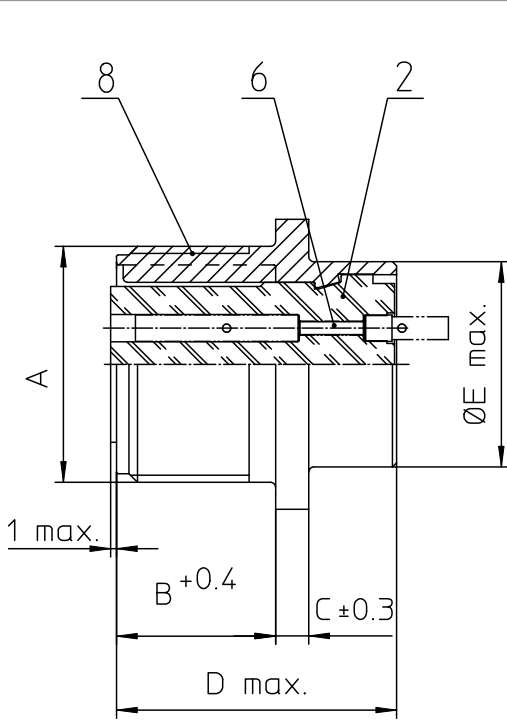

NO.	MASSE / DIMENSION
A	1 3/4-18NS-2A
B	20.6
C	4
D	34.2
E	41.2
F	39.7
G	50.8
H	3.7

NO.	BESCHREIBUNG / DESCRIPTION
2	ISOLIERKÖRPER BUCHSE / INSULATOR SOCKET
6	KONTAKTBUCHSE / CONTACT SOCKET
8	DOSENGEHÄUSE / SHELL

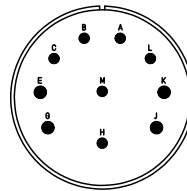

Note: Due to an automatic nomenclature system, numbers generated may not be sequential.
Specification and Dimensions subject to change Drawings illustrate normal insulator positioning
Material Specification:
Shell Material: Aluminium alloy
Shell Plating: Olive drab chromate coating over cadmium plating
Insulator Material: Neoprene
Contact Material: Copper alloy
Contact Plating: Hard silver

all dimensions are in mm Dimensions without tolerance indications are general tolerances in acc. with DIN7168m	drawing for CUSTOMER
 description CA3102E28-19S-F80 Box mounting receptacle AWG Crimp / Socket / Layout: 28-19	
© All rights reserved. Reproduction or sale to third in any form without the written authorization of ITT Cannon is strictly prohibited.	page 1/1 revision 3773, Jul 16