

## **Excellent Integrated System Limited**

Stocking Distributor

Click to view price, real time Inventory, Delivery & Lifecycle Information:

[Hammond Manufacturing](#)  
[1411G](#)

For any questions, you can email us directly:

[sales@integrated-circuit.com](mailto:sales@integrated-circuit.com)

**Top View of Assembly**

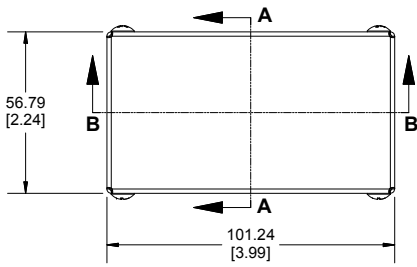

**SECTION A-A  
End View of Assembly**

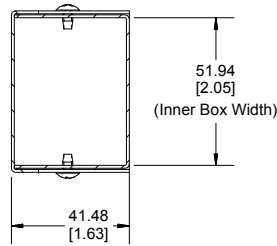

**SECTION B-B  
Side View of Assembly**

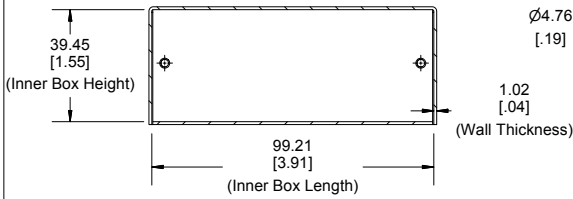

**Cover**

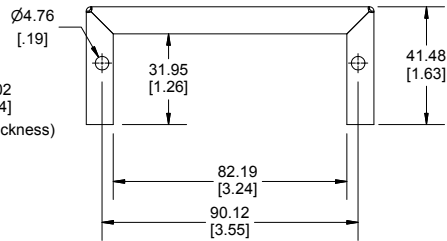

**Bottom**

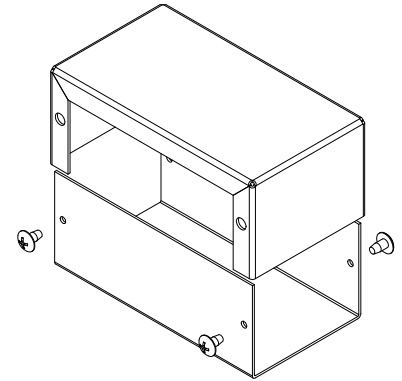
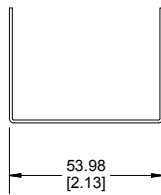
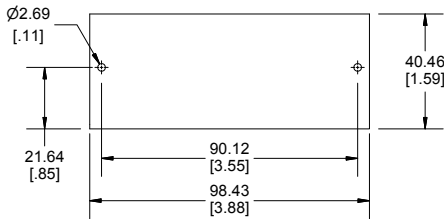

Enclosures can be Factory Modified ( Milling, Drilling, Printing etc.)  
Contact Factory [mjm@hammondmfg.com](mailto:mjm@hammondmfg.com) for quotes  
Solid models of this enclosure available in STEP or IGES.

NOTE	
Purchased assembly includes bottom, cover and 4 cover screws. Bottom and cover are made from 0.04" Aluminum Panels.	
PART NUMBERS	
1411G Enclosure	
Natural Finish Enclosure	1411GU
ASA 61 Grey Enclosure	1411G
ACCESSORIES	
Plated Cover Screws (Pkg 6) [6-32 x 1/4" Self-Tapping Screws]	1421J6



**HAMMOND  
MANUFACTURING™**

**1411G**

www.hammondmfg.com

Dimensions:  
mm  
[inches]