



Excellent Integrated System Limited

Stocking Distributor

Click to view price, real time Inventory, Delivery & Lifecycle Information:

[ITT Cannon, LLC](#)
[CA3102E24-22SF80](#)

For any questions, you can email us directly:
sales@integrated-circuit.com

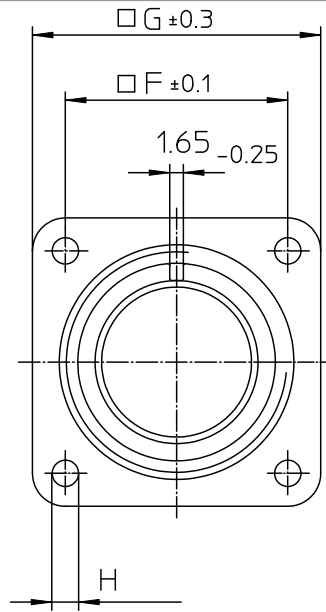
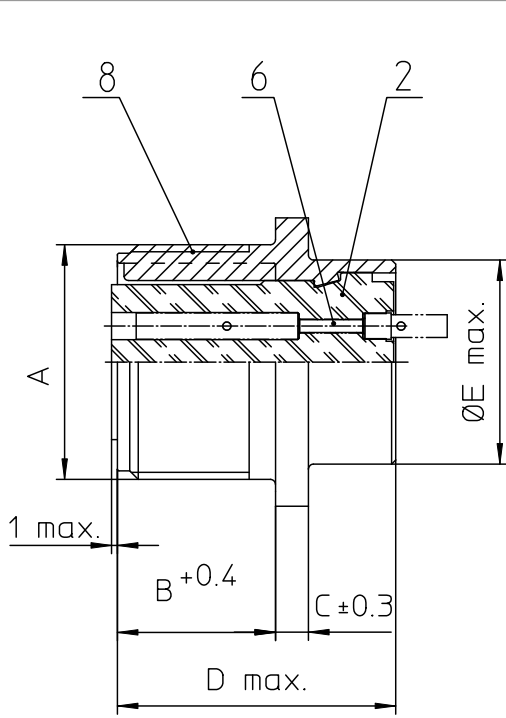

NO.	MASSE / DIMENSION
A	1 1/2-18NEF-2A
B	20.6
C	4
D	34.2
E	35.3
F	34.9
G	44.5
H	3.7

NO.	BESCHREIBUNG / DESCRIPTION
2	ISOLIERKÖRPER BUCHSE / INSULATOR SOCKET
6	KONTAKTBUCHSE / CONTACT SOCKET
8	DOSENGEHÄUSE / SHELL

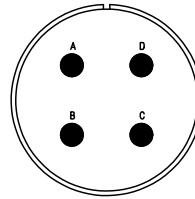

<p>Note: Due to an automatic nomenclature system, numbers generated may not be sequential.</p> <p>Specification and Dimensions subject to change. Drawings illustrate normal insulator positioning.</p>	
<p>Material Specification: _____</p>	
Shell Material:	Aluminium alloy
Shell Plating:	Olive drab chromate coating over cadmium plating
Insulator Material:	Neoprene
Contact Material:	Copper alloy
Contact Plating:	Hard silver

<p>all dimensions are in mm</p> <p>Dimensions without tolerance indications are general tolerances in acc. with DIN 1880</p>	<p>drawing for</p> <p>CUSTOMER</p>
<p>ITT</p> <p>Engineered for life</p> <p>ITT Cannon Corp. D-71364 Weinstadt Germany</p>	<p>description CA3102E24-22S-F80</p> <p>Box mounting receptacle</p> <p>AWG Crimp / Socket / Layout: 24-22</p>
<p>© All rights reserved. Reproduction or issue in any form without the prior written permission of ITT Cannon is prohibited.</p>	<p>page 1/1</p> <p>revision 377.3, Jul 16</p>