



Excellent Integrated System Limited

Stocking Distributor

Click to view price, real time Inventory, Delivery & Lifecycle Information:

[ITT Cannon, LLC](#)
[CA3106E24-19PB02](#)

For any questions, you can email us directly:
sales@integrated-circuit.com

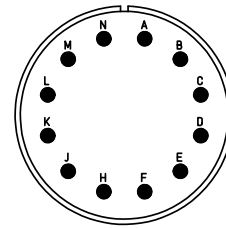
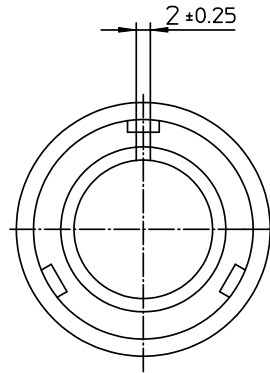
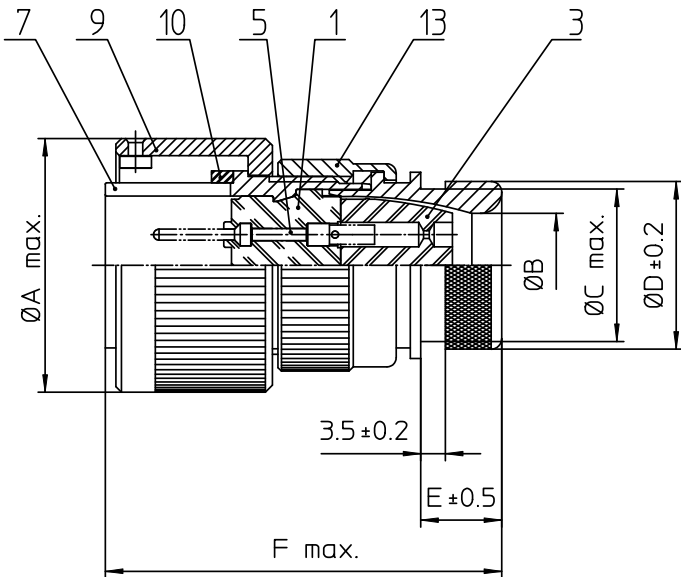

NO.	MASSE / DIMENSION
A	46.6
B	24.6
C	34.5
D	38.1
E	12.7
F	65

NO.	BESCHREIBUNG / DESCRIPTION
1	ISOLIERKÖRPER STIFT / INSULATOR PIN
3	DICHTKÖRPER / GROMMET
5	KONTAKTSTIFT / CONTACT PIN
7	ZYLINDERGHÄUSE / BARREL
9	ÜBERWURFMUTTER / COUPLING NUT
10	DICHTRING FRONT / FRONT SEALING RING
13	ENDGEHÄUSE DN / ENDBELL HEATSHRINK

Note: Due to an automatic nomenclature system, numbers generated may not be sequential.
Specification and Dimensions subject to change
Drawings illustrate normal insulator positioning

Material Specification:	
Shell Material:	Aluminium alloy
Shell Plating:	Olive drab chromate over cadmium (conductive)
Insulator Material:	CR-Elastomere
Contact Material:	Copper alloy
Contact Plating:	Hard silver

all dimensions are in mm

Dimensions without tolerance indications are general tolerances in acc. with DIN7168m

drawing for
CUSTOMER



description CA3106E24-19P-B-02
Plug, straight
Endbell for heatshrinkable boots
AWG Crimp / Pin / Layout: 24-19

© All rights reserved. Reproduction or use in any form
whenever is only permitted with written authorization of ITT Cannon

page 1/1 revision 786 4. Jul 16