



Excellent Integrated System Limited

Stocking Distributor

Click to view price, real time Inventory, Delivery & Lifecycle Information:

[ITT Cannon, LLC](#)
[KPT02E16-26SEX](#)

For any questions, you can email us directly:

sales@integrated-circuit.com

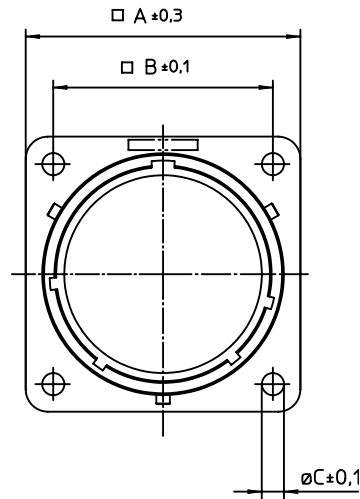
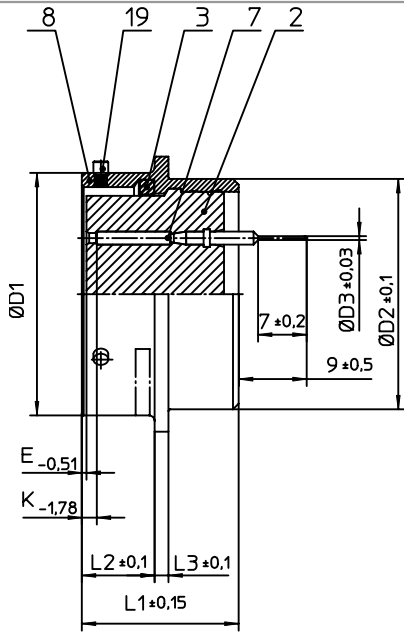

NO.	MASSE / DIMENSION
A	30.9
B	24.6
C	3.2
D1	25.4
D2	23.7
D3	0.76
E	0.46
K	3.89
L1	21.1
L2	11.6
L3	1.9

NO.	BESCHREIBUNG / DESCRIPTION
2	ISOLIERKÖRPER BUCHSE / INSULATOR SOCKET
3	DICHTRING / GASKET
7	KONTAKT BUCHSE / CONTACT SOCKET
8	GEHÄUSE / RECEPTACLE
19	BAYONETTSTIFT / BAYONET PIN

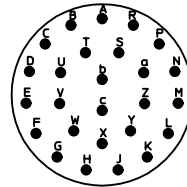

Note: Due to an automatic nomenclature system, numbers generated may not be sequential.
Specification and Dimensions subject to change Drawings illustrate normal insulator positioning
Material Specification:
Shell Material: Aluminium alloy
Shell Plating: Olive drab chromate over cadmium plating
Insulator Material: Polychloroprene
Contact Material: Copper alloy, gold plated
Contact Plating: Copper alloy, gold plated

all dimensions are in mm Dimensions without tolerance indications are general tolerances in acc. with DIN7168m	drawing for CUSTOMER
 ITT <i>Engineered for life</i> <small>ITT CANNON GmbH D-71334 Wernau/Germany</small>	description KPT02E1626SEX Box mounting receptacle Solder Pin 0.76 x 7 mm / Socket / Layout: 16-26
<small>© All rights reserved. Reproduction or issue to third in any form whenever is only permitted with written authorization of ITT Cannon</small>	page revision 1/2 1013 5. Jul 16