

Excellent Integrated System Limited

Stocking Distributor

Click to view price, real time Inventory, Delivery & Lifecycle Information:

[Richtek USA Inc.](#)
[RT9010-12GJ6](#)

For any questions, you can email us directly:

sales@integrated-circuit.com

300mA LDO Regulator with POR

General Description

RT9010 is a low noise, and low dropout with the sourcing ability up to 300mA and power-on reset function. The range of output voltage is from 1.2V to 3.6V by operating from 2.5V to 5.5V input.

RT9010 offers 2% accuracy, extremely low dropout voltage (240mV @ 300mA), and extremely low ground current. The shutdown current is near zero current which is suitable for battery-power devices. Other features include current limiting, over temperature, output short circuit protection.

RT9010 is short circuit thermal folded back protected. RT9010 lowers its OTP trip point from 165°C to 110°C when output short circuit occurs ($V_{OUT} < 0.4V$) providing maximum safety to end users.

RT9010 can operate stably with very small ceramic output capacitors, reducing required board space and component cost. RT9010 is available in fixed output voltages in the TSOT-23-6 package.

Ordering Information

RT9010-□□□□	
□	Package Type J6 : TSOT-23-6
□	Lead Plating System P : Pb Free G : Green (Halogen Free and Pb Free)
□	Output Voltage 12 : 1.20V 13 : 1.30V : : 35 : 3.50V 36 : 3.60V 1H : 1.85V 2F : 2.65V 2H : 2.85V

Note :

Richtek products are :

- ▶ RoHS compliant and compatible with the current requirements of IPC/JEDEC J-STD-020.
- ▶ Suitable for use in SnPb or Pb-free soldering processes.

Features

- Wide Operating Voltage Ranges : 2.5V to 5.5V
- Low-Noise for RF Application
- No Noise Bypass Capacitor Required
- Fast Response in Line/Load Transient
- TTL-Logic-Controlled Shutdown Input
- Low Temperature Coefficient
- 300mA LDO Outputs
- High Accuracy $\pm 2\%$
- Short Circuit Protection
- Thermal Shutdown Protection
- Current Limit Protection
- Short Circuit Thermal Folded Back Protection
- Tiny TSOT-23-6 Package
- RoHS Compliant and 100% Lead (Pb)-Free

Applications

- CDMA/GSM Cellular Handsets
- Battery-Powered Equipment
- Laptop, Palmtops, Notebook Computers
- Hand-Held Instruments
- PCMCIA Cards
- Portable Information Appliances

Pin Configurations

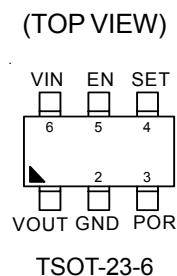

Marking Information

For marking information, contact our sales representative directly or through a Richtek distributor located in your area.

RT9010



Typical Application Circuit

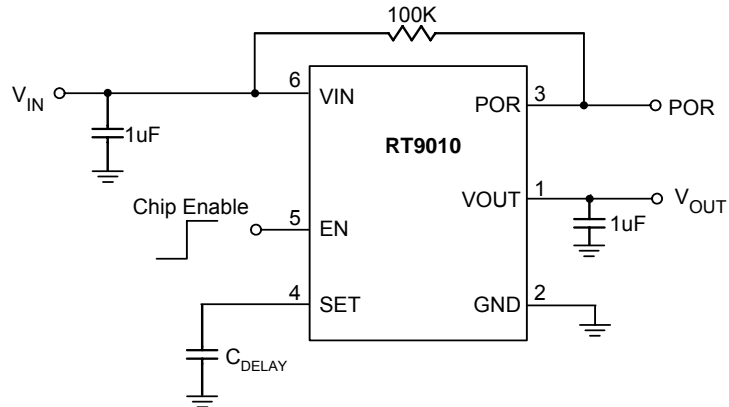

Functional Pin Description

Pin No.	Pin Name	Pin Function
1	VOUT	Output Voltage.
2	GND	Common Ground.
3	POR	Power-On Reset Output : Open-drain output. Active low indicates an output under voltage condition on regulator.
4	SET	Delay Set Input. Connect external capacitor to GND to set the internal delay.
5	EN	Chip Enable (Active High).
6	VIN	Supply Input Voltage.

Function Block Diagram

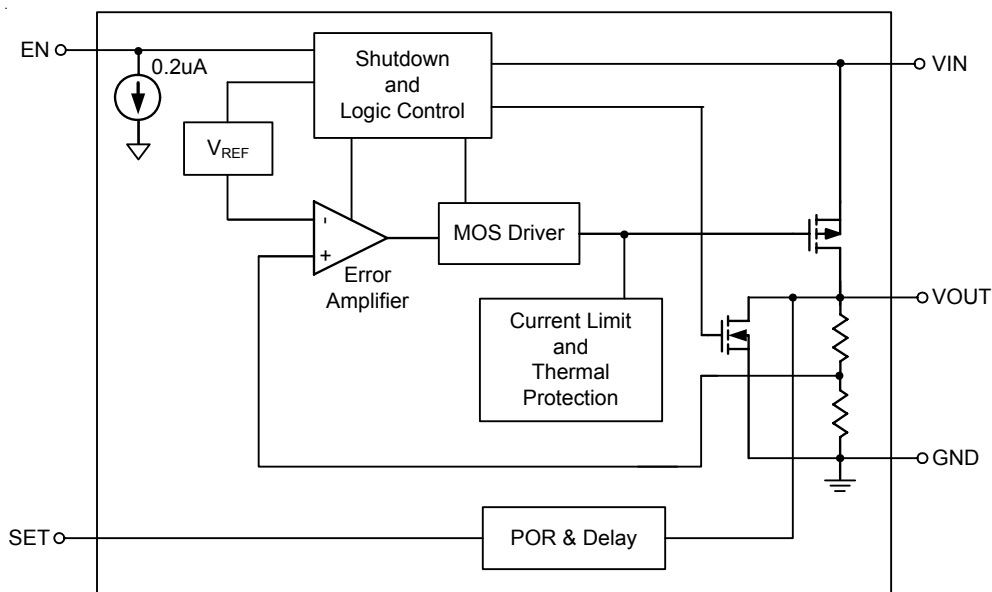

RICHTEK

RT9010

Absolute Maximum Ratings (Note 1)

• Supply Input Voltage	-----	-0.3V to 6V
• Other I/O Pin Voltages	-----	-0.3V to 6V
• Power Dissipation, P_D @ $T_A = 25^\circ\text{C}$		
TSOT-23-6	-----	0.455W
• Package Thermal Resistance (Note 2)		
TSOT-23-6, θ_{JA}	-----	220°C/W
• Lead Temperature (Soldering, 10 sec.)	-----	260°C
• Junction Temperature	-----	150°C
• Storage Temperature Range	-----	-65°C to 150°C
• ESD Susceptibility (Note 3)		
HBM (Human Body Mode)	-----	2kV
MM (Machine Mode)	-----	200V

Recommended Operating Conditions (Note 4)

• Supply Input Voltage	-----	2.5V to 5.5V
• Enable Input Voltage	-----	0V to 5.5V
• Junction Temperature Range	-----	-40°C to 125°C
• Ambient Temperature Range	-----	-40°C to 85°C

Electrical Characteristics

($V_{IN} = V_{OUT} + 1V$, $V_{EN} = V_{IN}$, $C_{IN} = C_{OUT} = 1\mu\text{F}$, $T_A = 25^\circ\text{C}$, unless otherwise specified.)

Parameter	Symbol	Test Conditions	Min	Typ	Max	Unit	
Input Voltage	V_{IN}	$V_{IN} = 2.5V$ to 5.5V	2.5	–	5.5	V	
Dropout Voltage (Note 5)	V_{DROP}	$I_{OUT} = 150\text{mA}$, $V_{OUT} > 2.8V$	--	120	--	mV	
		$I_{OUT} = 300\text{mA}$, $V_{OUT} > 2.8V$	--	240	--	mV	
Output Voltage Range	V_{OUT}		1.2	–	3.6	V	
Output Voltage Accuracy	ΔV_{OUT}	$I_{OUT} = 1\text{mA}$	-2	–	+2	%	
Line Regulation	ΔV_{LINE}	$V_{IN} = (V_{OUT} + 0.3V)$ to 5.5V or $V_{IN} > 2.5V$, whichever is larger	--	–	0.2	%/V	
Load Regulation	ΔV_{LOAD}	$1\text{mA} < I_{OUT} < 300\text{mA}$	--	–	0.6	%	
Current Limit	I_{LIM}	$R_{LOAD} = 1\Omega$	330	450	700	mA	
Quiescent Current	I_Q	$V_{EN} > 1.5V$	--	58	80	μA	
Shutdown Current	I_{Q_SD}	$V_{EN} < 0.4V$	--	–	1	μA	
EN Threshold Voltage	Logic-High	V_{IH}	$V_{IN} = 2.5V$ to 5.5V, Power On	1.5	–	--	V
	Logic-Low	V_{IL}	$V_{IN} = 2.5V$ to 5.5V, Shutdown	--	–	0.4	
Output Voltage TC			--	100	--	ppm/°C	
Thermal Shutdown	T_{SD}		--	170	--	°C	
Thermal Shutdown Hysteresis	ΔT_{SD}		--	40	--	°C	

To be continued

RT9010



Parameter	Symbol	Test Conditions	Min	Typ	Max	Unit
PSRR Loading=10mA	PSRR	f =100Hz	–	–65	–	dB
		f =1kHz	–	–60	–	dB
		f =10kHz	–	–50	–	dB
PSRR Loading=150mA	PSRR	f =100Hz	–	–65	–	dB
		f =1kHz	–	–50	–	dB
		f =10kHz	–	–50	–	dB
Reset Threshold	V _{THL}	Low Threshold, % of nominal V _{OUT} (Flag On)	90	--	--	%
	V _{THH}	High Threshold, % of nominal V _{OUT} (Flag Off)	–	--	96	%
POR Output Logic Low Voltage	V _{POR_L}	I _L = 250μA	–	0.02	0.1	V
POR Leakage Current	I _{POR}	Flag off	–1	0.01	1	μA
Set pin current source		V _{SET} = 0	0.60	1.25	1.70	μA
Set pin threshold		POR = high	–	1.4	–	V

Note 1. Stresses listed as the above "Absolute Maximum Ratings" may cause permanent damage to the device. These are for stress ratings. Functional operation of the device at these or any other conditions beyond those indicated in the operational sections of the specifications is not implied. Exposure to absolute maximum rating conditions for extended periods may remain possibility to affect device reliability.

Note 2. θ_{JA} is measured in the natural convection at $T_A = 25^\circ\text{C}$ on a low effective thermal conductivity test board of JEDEC 51-3 thermal measurement standard.

Note 3. Devices are ESD sensitive. Handling precaution recommended.

Note 4. The device is not guaranteed to function outside its operating conditions.

Note 5. The dropout voltage is defined as $V_{IN} - V_{OUT}$, which is measured when V_{OUT} is $V_{OUT(NORMAL)} - 100\text{mV}$.

Typical Operating Characteristics

Output Voltage vs. Temperature

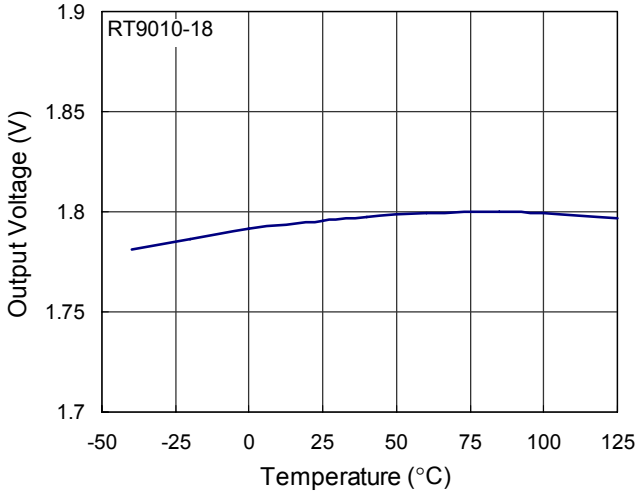

Output Voltage vs. Temperature

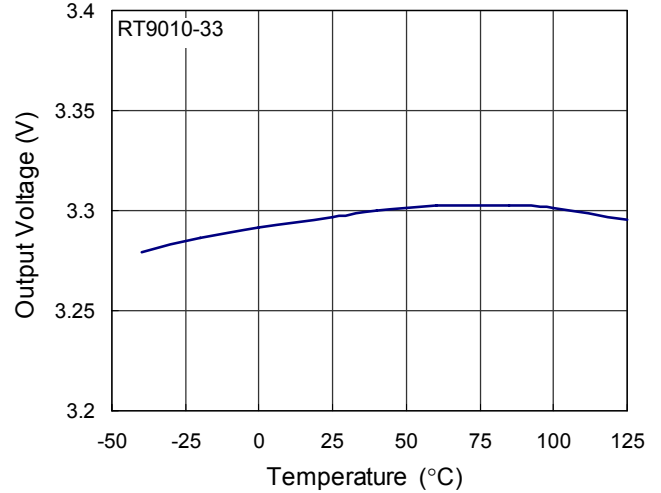

Quiescent Current vs. Temperature

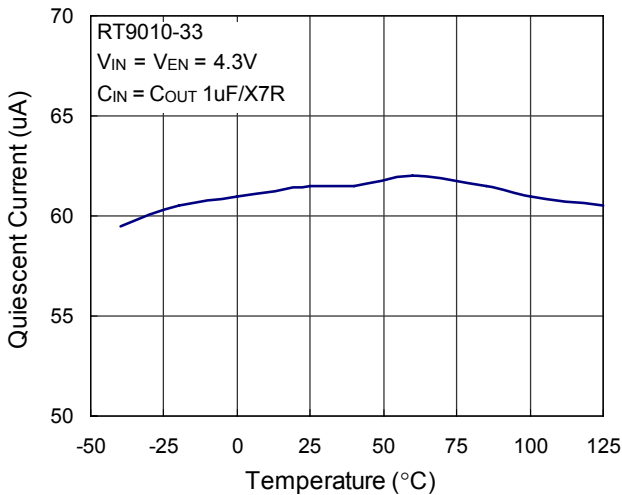

Dropout Voltage vs. Load Current

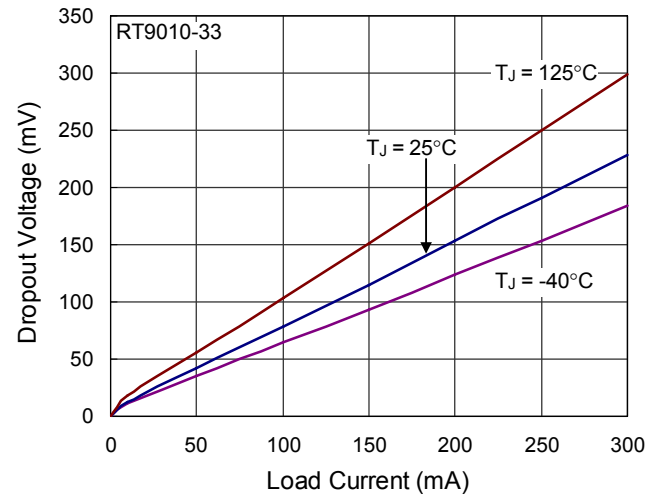

PSRR

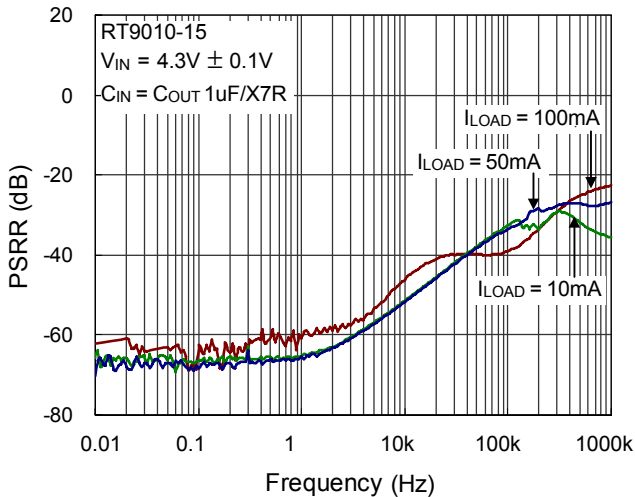

POR Delay

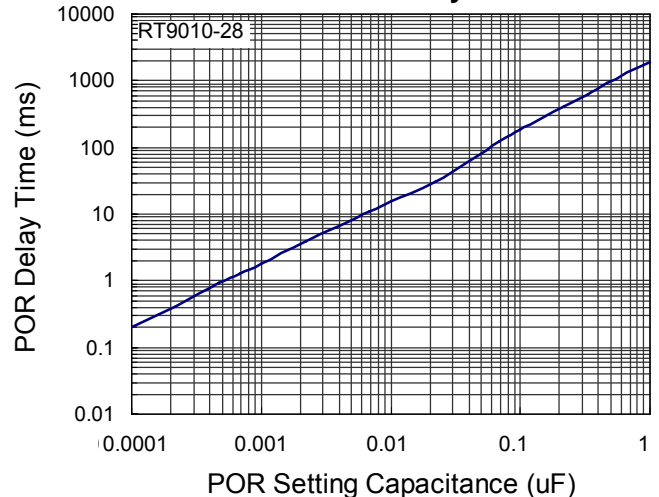

RT9010



Line Transient Response

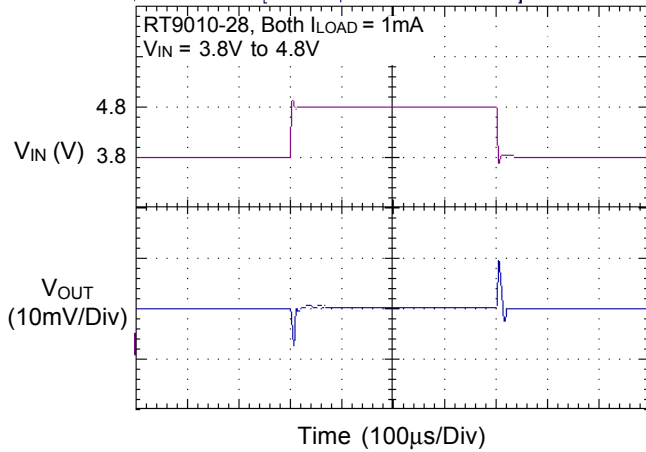

Line Transient Response

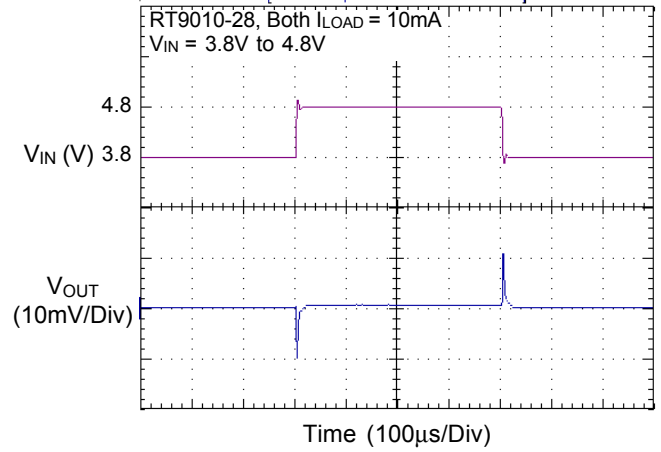

Line Transient Response

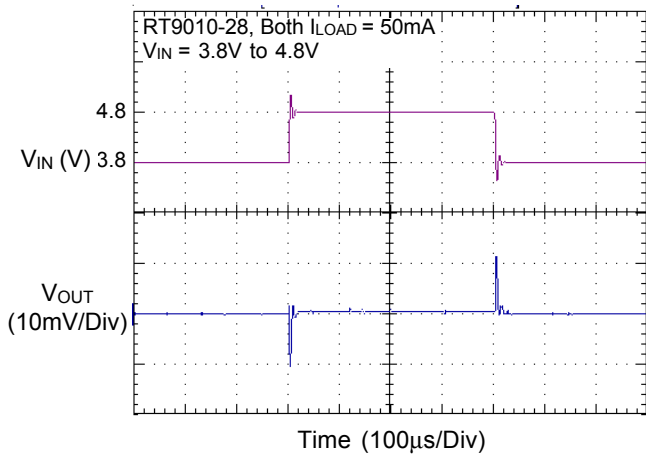

Line Transient Response

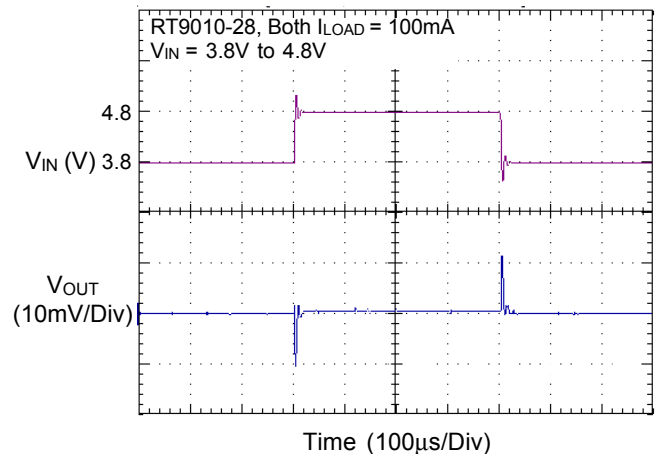

Load Transient Response

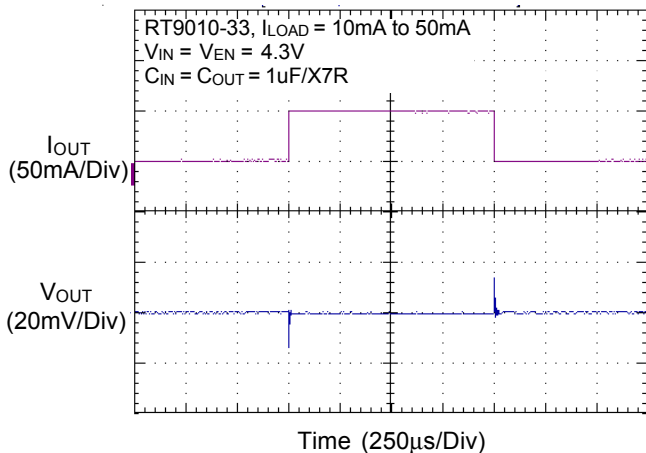

Load Transient Response

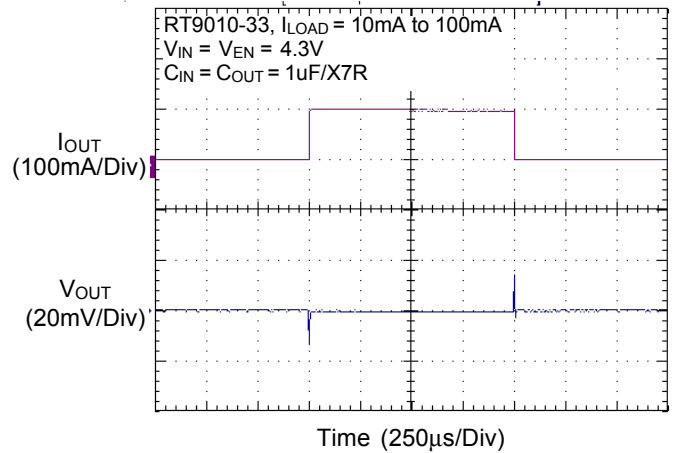

Start Up

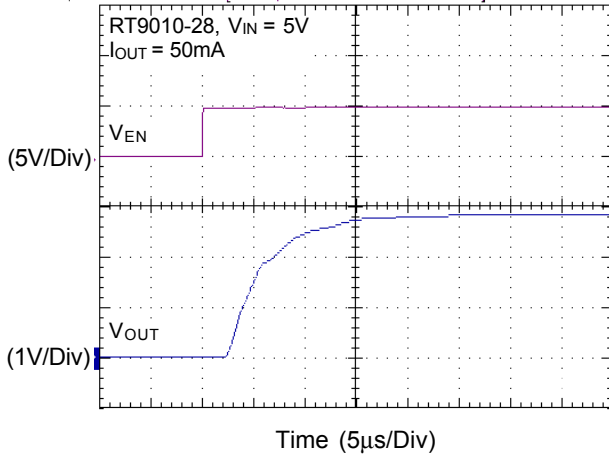

EN Pin Shutdown Response

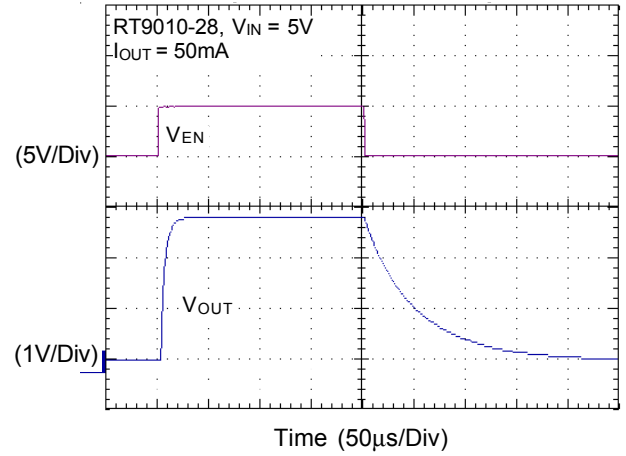

Power-On

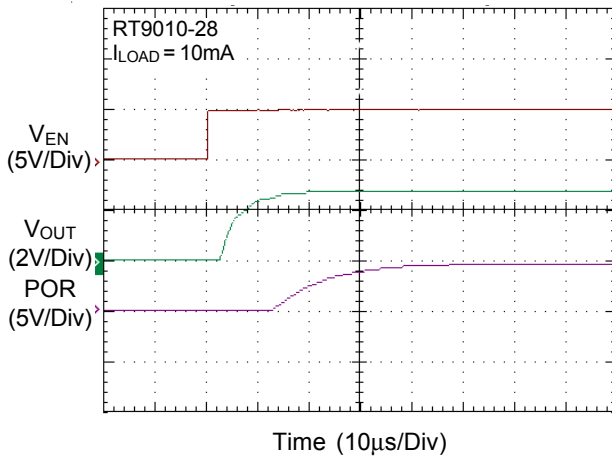

Noise

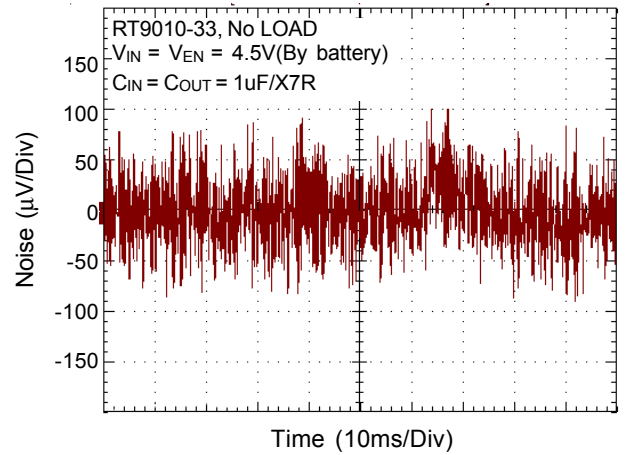

Noise

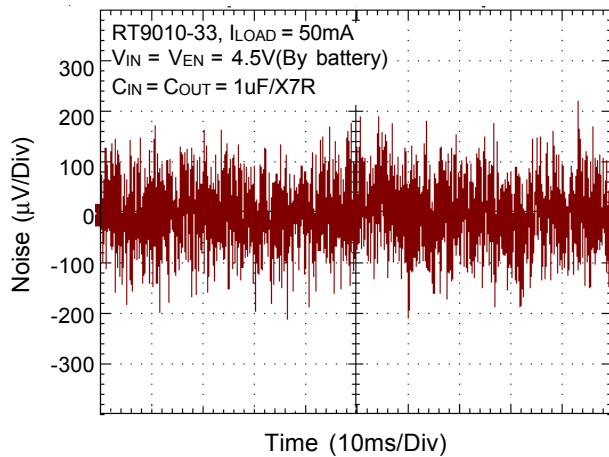

RT9010



Applications Information

Like any low-dropout regulator, the external capacitors used with the RT9010 must be carefully selected for regulator stability and performance. Using a capacitor whose value is $> 1\mu\text{F}$ on the RT9010 input and the amount of capacitance can be increased without limit. The input capacitor must be located a distance of not more than 0.5 inch from the input pin of the IC and returned to a clean analog ground. Any good quality ceramic or tantalum can be used for this capacitor. The capacitor with larger value and lower ESR (equivalent series resistance) provides better PSRR and line-transient response.

The output capacitor must meet both requirements for minimum amount of capacitance and ESR in all LDOs application. The RT9010 is designed specifically to work with low ESR ceramic output capacitor in space-saving and performance consideration. Using a ceramic capacitor whose value is at least $1\mu\text{F}$ with ESR is $> 20\text{m}\Omega$ on the RT9010 output ensures stability. The RT9010 still works well with output capacitor of other types due to the wide stable ESR range. Figure 1. shows the curves of allowable ESR range as a function of load current for various output capacitor values. Output capacitor of larger capacitance can reduce noise and improve load transient response, stability, and PSRR. The output capacitor should be located not more than 0.5 inch from the VOUT pin of the RT9010 and returned to a clean analog ground.

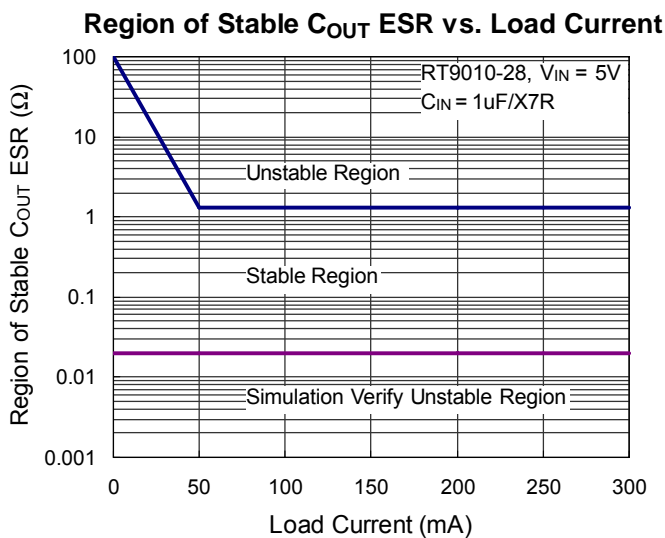

Figure 1. Stable C_{OUT} ESR Range

Thermal Considerations

Thermal protection limits power dissipation in RT9010. When the operation junction temperature exceeds 170°C, the OTP circuit starts the thermal shutdown function and turns the pass element off. The pass element turn on again after the junction temperature cools by 40°C. RT9010 lowers its OTP trip level from 170°C to 110°C when output short circuit occurs (V_{OUT} < 0.4V) as shown in Figure 2. It limits IC case temperature under 100°C and provides maximum safety to customer while output short circuit occurring.

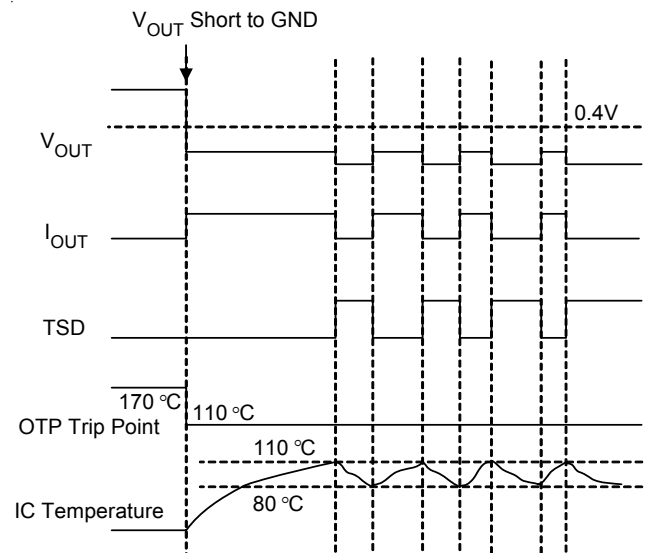

Figure 2. Short Circuit Thermal Folded Back Protection when Output Short Circuit Occurs (Patent)

For continuous operation, do not exceed absolute maximum operation junction temperature 125°C. The power dissipation definition in device is :

$$P_D = (V_{IN} - V_{OUT}) \times I_{OUT} + V_{IN} \times I_Q$$

The maximum power dissipation depends on the thermal resistance of IC package, PCB layout, the rate of surroundings airflow and temperature difference between junction to ambient. The maximum power dissipation can be calculated by following formula :

$$P_{D(MAX)} = (T_{J(MAX)} - T_A) / \theta_{JA}$$

Where T_{J(MAX)} is the maximum operation junction temperature 125°C, T_A is the ambient temperature and the θ_{JA} is the junction to ambient thermal resistance.

For recommended operating conditions specification of RT9010, where $T_{J(MAX)}$ is the maximum junction temperature of the die ($125^{\circ}C$) and T_A is the operated ambient temperature. The junction to ambient thermal resistance (θ_{JA} is layout dependent) for TSOT-23-6 package is $220^{\circ}C/W$ on the standard JEDEC 51-3 single-layer thermal test board. The maximum power dissipation at $T_A = 25^{\circ}C$ can be calculated by following formula :

$$P_{D(MAX)} = (125^{\circ}C - 25^{\circ}C) / (220^{\circ}C/W) = 0.455 \text{ W for TSOT-23-6 packages}$$

The maximum power dissipation depends on operating ambient temperature for fixed $T_{J(MAX)}$ and thermal resistance θ_{JA} . For RT9010 packages, the Figure 3 of derating curves allows the designer to see the effect of rising ambient temperature on the maximum power allowed.

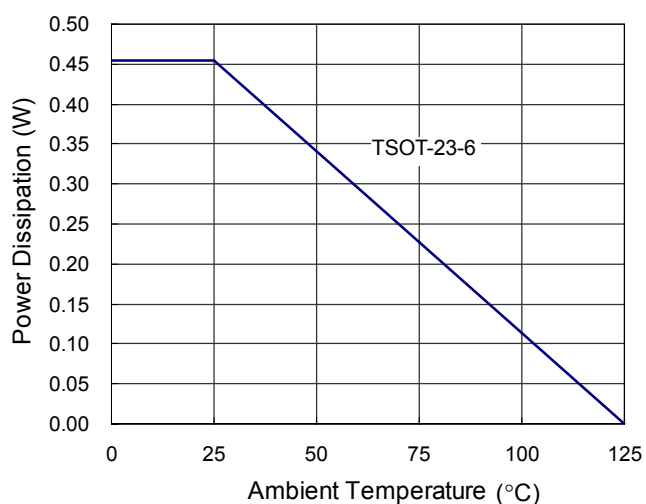
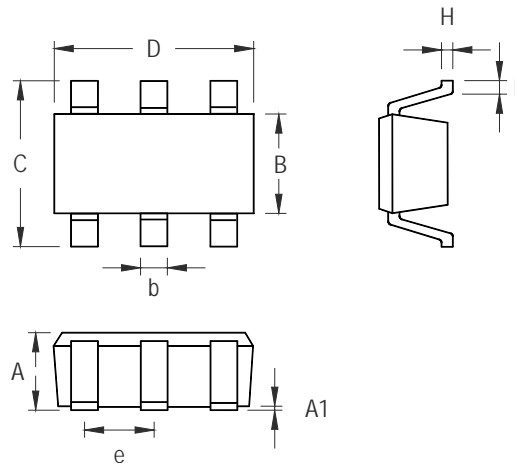

Figure 3. Derating Curves for RT9010 Packages

RT9010



Outline Dimension



Symbol	Dimensions In Millimeters		Dimensions In Inches	
	Min	Max	Min	Max
A	0.700	1.000	0.028	0.039
A1	0.000	0.100	0.000	0.004
B	1.397	1.803	0.055	0.071
b	0.300	0.559	0.012	0.022
C	2.591	3.000	0.102	0.118
D	2.692	3.099	0.106	0.122
e	0.838	1.041	0.033	0.041
H	0.080	0.254	0.003	0.010
L	0.300	0.610	0.012	0.024

TSOT-23-6 Surface Mount Package

Richtek Technology Corporation

Headquarter
 5F, No. 20, Taiyuen Street, Chupei City
 Hsinchu, Taiwan, R.O.C.
 Tel: (8863)5526789 Fax: (8863)5526611

Richtek Technology Corporation

Taipei Office (Marketing)
 5F, No. 95, Minchiuan Road, Hsintien City
 Taipei County, Taiwan, R.O.C.
 Tel: (8862)86672399 Fax: (8862)86672377
 Email: marketing@richtek.com

Information that is provided by Richtek Technology Corporation is believed to be accurate and reliable. Richtek reserves the right to make any change in circuit design, specification or other related things if necessary without notice at any time. No third party intellectual property infringement of the applications should be guaranteed by users when integrating Richtek products into any application. No legal responsibility for any said applications is assumed by Richtek.