

Excellent Integrated System Limited

Stocking Distributor

Click to view price, real time Inventory, Delivery & Lifecycle Information:

[Phoenix Contact](#)
[2199566](#)

For any questions, you can email us directly:

sales@integrated-circuit.com



Extract from the online catalog

GMSTBO 2,5 HV/ 3-GR-7,25 THR

Order No.: 2199566



<http://eshop.phoenixcontact.de/phoenix/treeViewClick.do?UID=2199566>

Header, Nominal current: 16 A, Rated voltage (III/2): 630 V, Color: black, Assembly: SMD/THT/THR

Commercial data	
GTIN (EAN)	 4 046356 495318
Note	Made-to-order
sales group	F057
Pack	50 pcs.
Customs tariff	85366990
Catalog page information	Page 181 (NTK-2010)

Product notes

WEEE/RoHS-compliant since:
02/19/2009



<http://www.download.phoenixcontact.com>
 Please note that the data given here has been taken from the online catalog. For comprehensive information and data, please refer to the user documentation. The General Terms and Conditions of Use apply to Internet downloads.

Technical data

Dimensions / positions	
Dimension a	14.5 mm
Pin dimensions	1,0 x 1,0 mm
Pin spacing	7.25 mm
Hole diameter	1.5 mm

GMSTBO 2,5 HV/ 3-GR-7,25 THR Order No.: 2199566
<http://eshop.phoenixcontact.de/phoenix/treeViewClick.do?UID=2199566>

Technical data

Insulating material group	IIIa
Rated surge voltage (III/3)	6 kV
Rated surge voltage (III/2)	6 kV
Rated surge voltage (II/2)	6 kV
Rated voltage (III/2)	630 V
Rated voltage (II/2)	630 V
Connection in acc. with standard	EN-VDE
Nominal current I_N	16 A
Nominal voltage U_N	400 V
Maximum load current	16 A
Insulating material	LCP
Inflammability class acc. to UL 94	V0

Diagrams/Drawings

Drilling plan/solder pad geometry

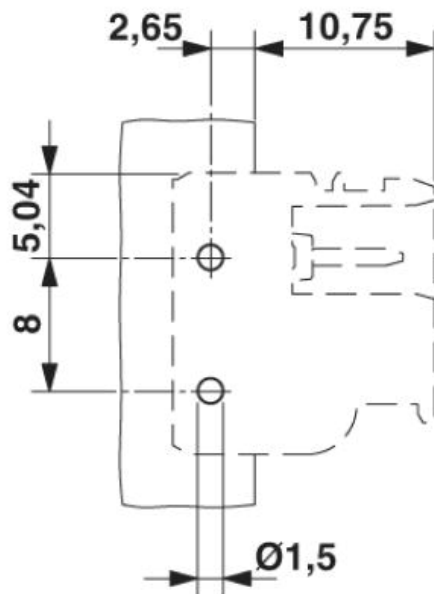

GMSTBO 2,5 HV/ 3-GR-7,25 THR Order No.: 2199566

<http://eshop.phoenixcontact.de/phoenix/treeViewClick.do?UID=2199566>

Dimensioned drawing

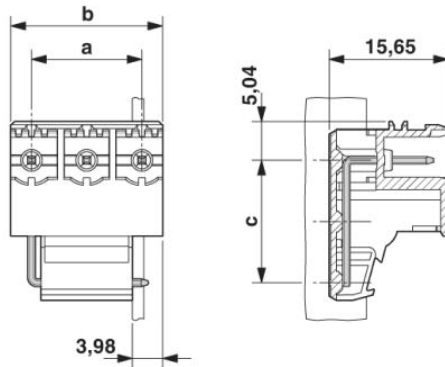

GMSTBO 2,5 HV/ 3-GR-7,25 THR Order No.: 2199566
<http://eshop.phoenixcontact.de/phoenix/treeViewClick.do?UID=2199566>

Address

PHOENIX CONTACT Inc., USA
586 Fulling Mill Road
Middletown, PA 17057, USA
Phone (800) 888-7388
Fax (717) 944-1625
<http://www.phoenixcon.com>



© 2011 Phoenix Contact
Technical modifications reserved;