

Excellent Integrated System Limited

Stocking Distributor

Click to view price, real time Inventory, Delivery & Lifecycle Information:

[Omron Automation & Safety](#)
[R88A-TK01U](#)

For any questions, you can email us directly:

sales@integrated-circuit.com

Omron's Solutions in Motion



Complete Solutions

Omron's new line of servomotors and drives completes your Omron industrial automation solution. The 'U' series servo system combines an ultra-small brushless servomotor matched with a flexible, rugged servo drive. Whether you require 100VAC or 200VAC, incremental or absolute encoder feedback, pulse or analog input, Omron has a servo system to meet your requirements. The 'U' series is fully complemented by Omron's broad product line which includes PLCs, power supplies, operator interfaces, sensors, automatic identification solutions, and temperature and process controllers. Our 'plug and play' connections to Omron PLC motion control units give system designers and machine builders a high performance, flexible servo system that can be set up quickly for a variety of applications.

Satisfying a Variety of Applications

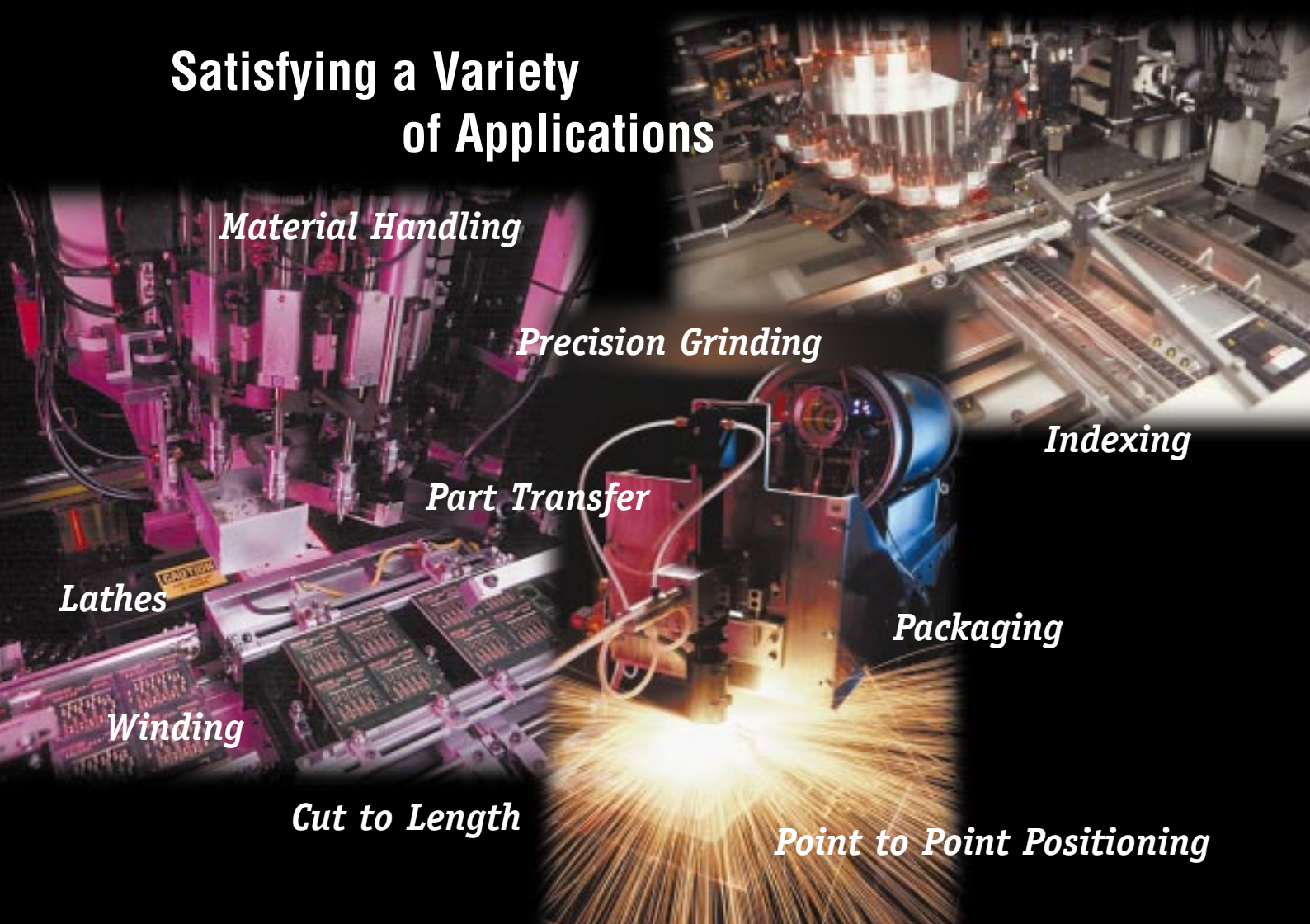

Material Handling

Precision Grinding

Indexing

Part Transfer

Packaging

Lathes

Winding

Cut to Length

Point to Point Positioning

Servo Drives

Servo Selection Options

The 'U' series gives you the choice of digital or analog drives so you can choose the best product for your application.

Small Sized and Lightweight

The use of small power modules and integration of electronic circuits, make a lightweight, small sized servo drive a reality. The small package size provides the designer an economical use of panel space.

Easy Operation

The drive parameters are divided into groups so that they can be easily set and monitored. Make changes to the parameters using either hand held or mounted parameter units or PC-based software.

Easy Wiring

We offer several special cables and plug-and-play capability, facilitating quick connections to Omron PLC Position and Motion Control Units.

Quick Adjustments

The auto-tuning function automatically adjusts the control system gain according to machine characteristics, reducing system start up time.

Quiet Operation

Using Insulated Gate Bi-Polar Transistors (IGBT) reduces audible noises.

Multi-Functional

Our servos are packed with several standard features, making them ideal for several different applications. Standard features include: soft start, torque control, reverse mode, internal speed control settings, encoder resolution, electrical gears, position lock, brake interlock and overtravel.

PC Compatible Communications

Use the dedicated software package for saving, reading and writing parameters from a personal computer. Easily perform system checks, make adjustments and evaluate operating status using the electric current, speed and I/O signal information graphically displayed on a PC.



Servo Motors

Durable and Ultra Small

The 'U' series motors are the AC brushless type that are built for a long, trouble-free life. Using rare-earth magnets and innovative magnetic circuits minimizes the motor's size and weight.

Smooth Rotation

Cogging torque has been reduced, so the motor rotates smoothly at low speeds. The motor's speed control range is 5,000:1.

High-Speed Positioning

The maximum rotational speed of 4,500 r/min. shortens positioning time and improves productivity.

Customize Your System

Available options include incremental or absolute encoders, straight or keyed shafts and a brake for holding when power is off. Users can choose the motor that best suits their application.

Low Inertia and High Power Rate

The low rotor inertia design yields a very high power rate and makes the 'U' series well suited for high speed positioning applications.

	Functions	4
	System Configuration	6
	Using Parameter Units	8
	Servomotor Specifications	11
	Torque and Rotation Speed Characteristics	14
	Servo Driver Specifications	15
	Options Specifications	18
	External Dimensions	19
	Terminal and Connector Functions (30 to 750 W)	23
	Special Cables	27
	Model Number Legend	28
	Standard Models	29
	Important Information	31

NOTE: Specifications to change without notice.

Warranty: Omron certifies all of its products either meet or exceed stipulated specifications. Omron is not liable for stenographic and/or clerical errors.

Omron's obligation under this warranty is limited solely to repair or replacement at Omron's discretion. Omron will not be liable for any design furnished by Buyer and incorporated into equipment.

This warranty is voided if the product is altered in any way or suffers consequential damage due to negligence or misuse.

Omron is not to suffer risk due to the suitability or unsuitability or the results of the use of its products used in combination with any electrical or electronic components, circuits, systems assemblies or any other materials or substances or environments.

The foregoing warning is the only warranty which Omron Electronics, Inc., provides with respect to the products listed herein. No other warranties, expressed, implied, or statutory shall apply, whether as to merchantability, fitness for a particular purpose, description, or otherwise.

Limitation of Liability: Notwithstanding any other statement herein, Omron Electronics, Inc., its contractors and suppliers, shall not be liable for any special, indirect, incidental or consequential damages. The remedies of the purchaser set forth herein are exclusive where so stated and the total cumulative liability of Omron Electronics, Inc., its contractors and suppliers, with respect to this contract or anything done in connection therewith, shall not exceed replacement price reimbursement as to the product on which such liability is based.

Functions

All your Servomotor functional needs combined - to make optimal operation a reality.

■ Soft Start

Speed Control

This function stops and starts the Servomotor within the set acceleration and deceleration times. A positioning system can be easily established, without the need for a positioner or host controller.

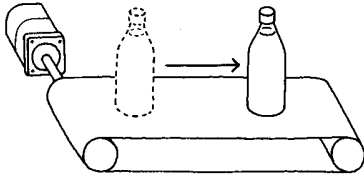
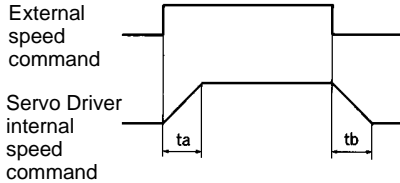

■ Torque Control

Torque Control

Controls the Servomotor using a torque proportional to the analog input voltage. It can be used for tension control and controlled stopping.

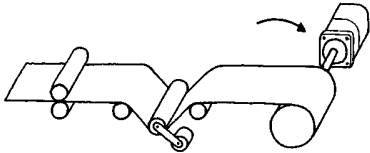

■ Reverse Rotation Mode

Position Control Speed Control

Torque Control

The forward and reverse rotation commands can be switched at the parameter level, without changing the Servomotor or encoder wiring.

Command	Default setting	Reverse rotation mode
Forward rotation command	CCW	CW
Reverse rotation command	CW	CCW

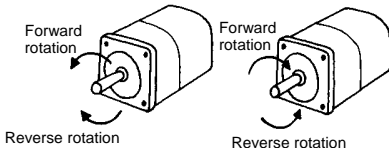

■ Internal Speed Control

Position Control Speed Control

With this function, the motor can be rotated at the first through third speeds set in the user parameters, making it easy to achieve positioning and speed switching operations.

Speed	Rotation direction command	Internal speed setting
Speed 1	Forward rotation	First speed
Speed 2		Second speed
Speed 3		Third speed
Speed 4	Reverse rotation	First speed
Speed 5		Second speed
Speed 6		Third speed
Stop	Servolock engaged	

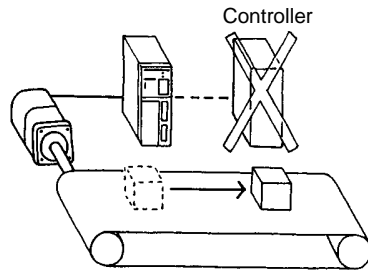

■ Encoder Resolution

Position Control Speed Control

Torque Control

The number of encoder pulses per motor rotation can be set to match the response frequency of the host controller.

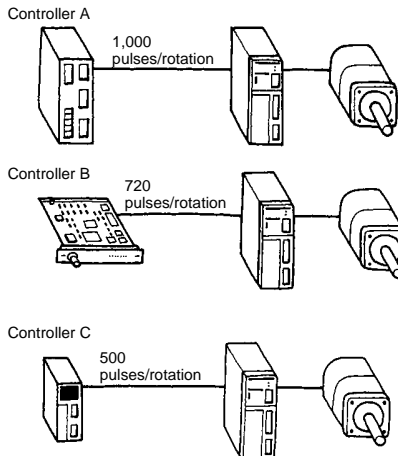

■ Position Lock

Speed Control

When the Servomotor stops, this function sets off the position loop and activates the position lock. It prevents drifts peculiar to analog input.

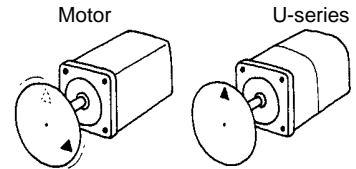

■ Electrical Gears

Position Control

The degree of movement per pulse can be set for each command.

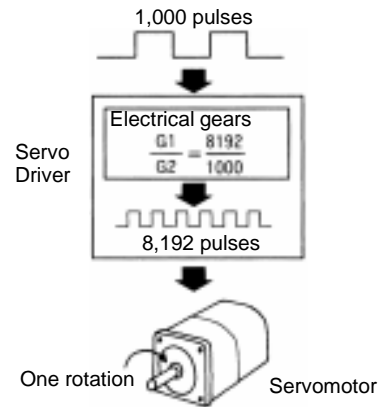

Functions

Rich Command Pulse Mode

Position Control

Available for all types of command pulse.

Logic setting	Command pulse mode	Motor forward command	Motor reverse command
Positive logic setting	Feed pulse and direction signal		
	90° phase difference signals A-, B-phase feed pulse (Multiplication by 1, 2, & 4 possible)		
	Reverse pulse and forward pulse		
Negative logic setting	Feed pulse and direction signal		
	90° phase difference signals A-, B-phase feed pulse (Multiplication by 1, 2, & 4 possible)		
	Reverse pulse and forward pulse		

Alarm History Display

Position Control Speed Control Torque Control

Stores the past ten errors, even if the power supply is cut off, making accurate troubleshooting possible.

Display (Alarm history)	Description
:	-
A40	Overvoltage detected
A51	Overspeed detected
A71	Overload detected
:	-

Bias Function

Position Control

This function can be used to reduce the position control time, according to the load conditions.

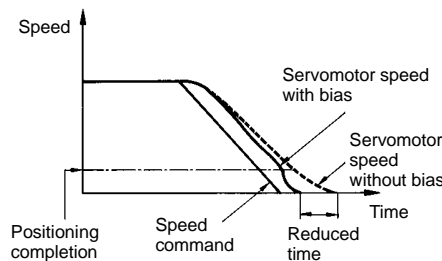

Feed-forward Function

Position Control

The stabilization period is reduced by using the feed-forward function.

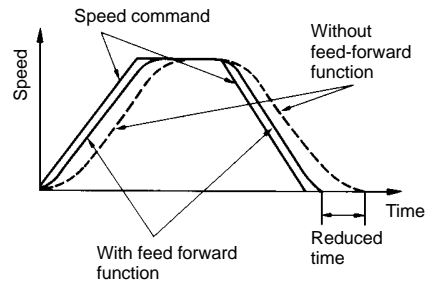

Torque Command Filter

Position Control Speed Control Torque Control

If the appropriate time constant is set, resonance with the load can be prevented.

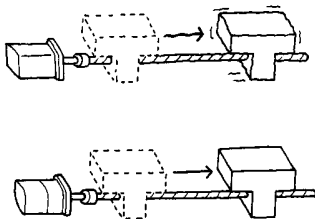

Brake Interlock

Position Control Speed Control Torque Control

Outputs a special signal, making the holding magnetic brake operating sequence easy.



Emergency Stop Torque

Position Control Speed Control Torque Control

The control torque for overtravel time can be set, preventing damage to machinery.

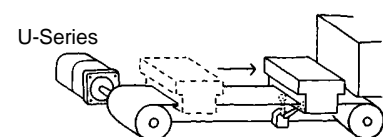
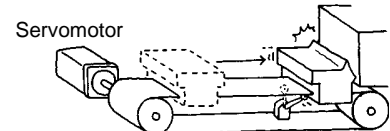

System Configuration

Our product synergy meets a variety of needs. When an OMRON Position Control Unit is used, the system configuration remains the same.

Position Control in a Mid-size System

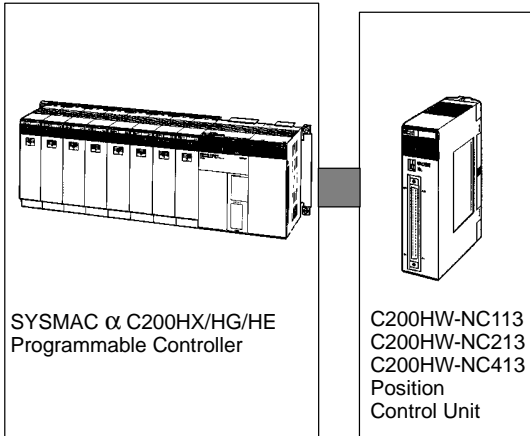

Position Control in a Large-rack System

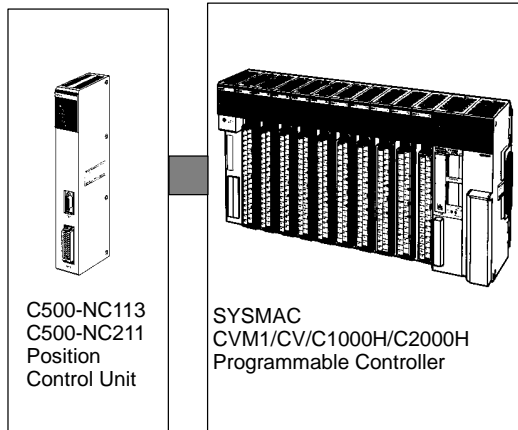

Pulse train input

Pulse Train Input Models

AC Servo Driver

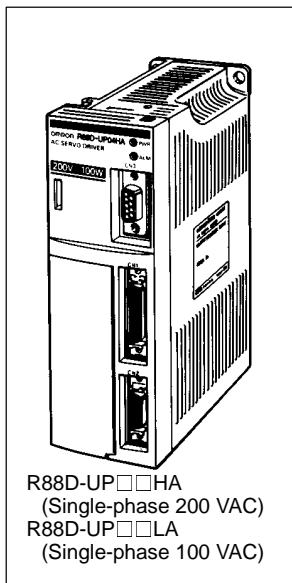

AC Servomotor with Incremental Encoder

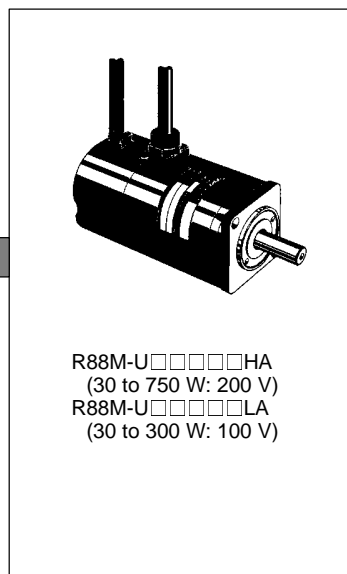

System Configuration

Multi-axis Control Using the G Language

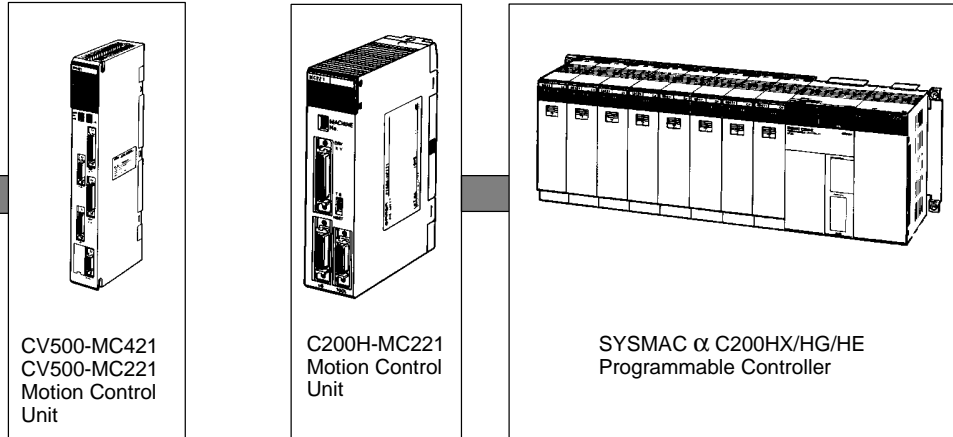

Analog input command

Analog Input Models

AC Servo Driver

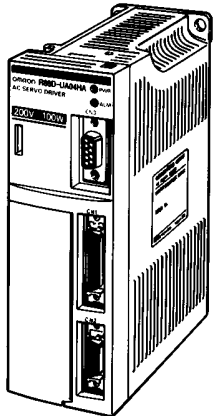

R88D-UA□□HA
(Single-phase 200 VAC)
R88D-UA□□LA
(Single-phase 100 VAC)

AC Servomotor with Incremental Encoder

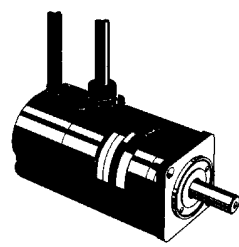

R88M-U□□□□HA
(30 to 750 W: 200 V)
R88M-U□□□□LA
(30 to 300 W: 100 V)

Using Parameter Units

Parameter Unit Keys and Functions

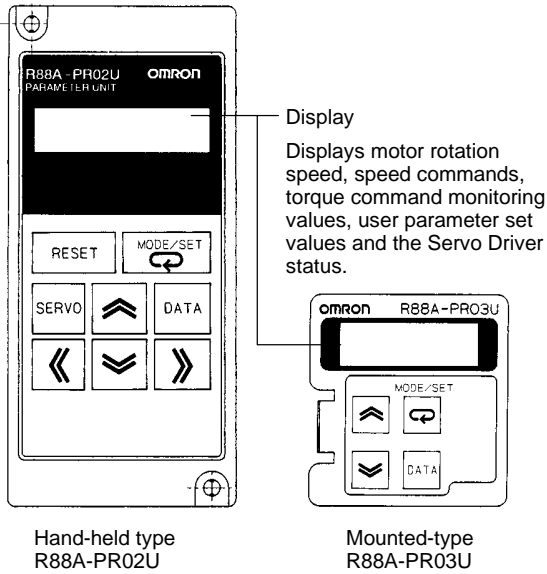

Keys

PR02U	PR03U	Function
RESET	↗ + ↘	Alarm reset
MODE/SET	↻	Mode switching Data memory
SERVO	DATA	Servo ON/OFF during jog operations
DATA	DATA	Switching between parameter display and data display; data memory
↗	↗	Increments parameter numbers and data values.
↘	↘	Decrements parameter numbers and data values.
↶		Left shift for operation digits
↷		Right shift for operation digits

Changing Modes

To change modes, press the MODE/SET Key.

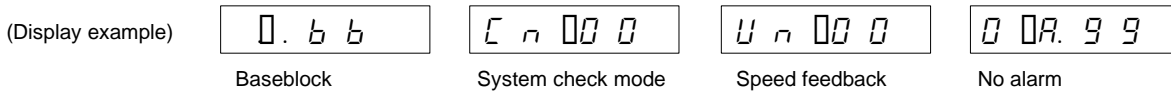
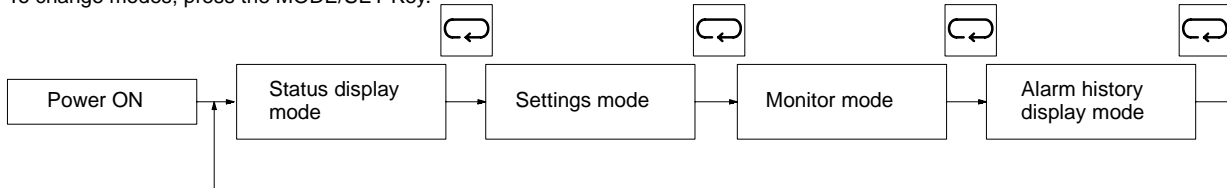

Status Display Mode

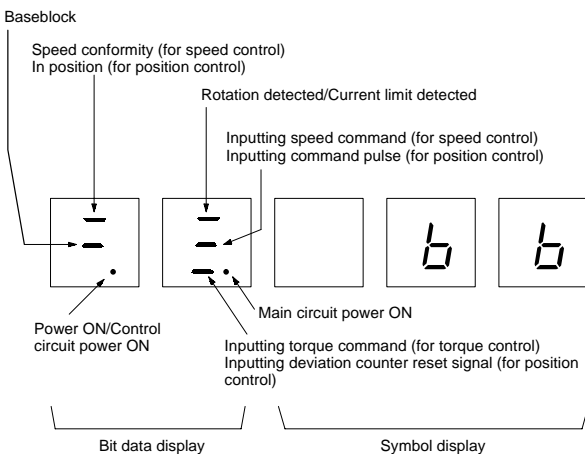

Symbol display	Contents
<i>bb</i>	Baseblock (no power to motor)
<i>run</i>	In operation (running)
<i>For</i>	Forward rotation prohibited
<i>ror</i>	Reverse rotation prohibited
<i>RA</i>	Alarm display (Refer to alarm table.)

Using Parameter Units

Mode Changes and Display Contents

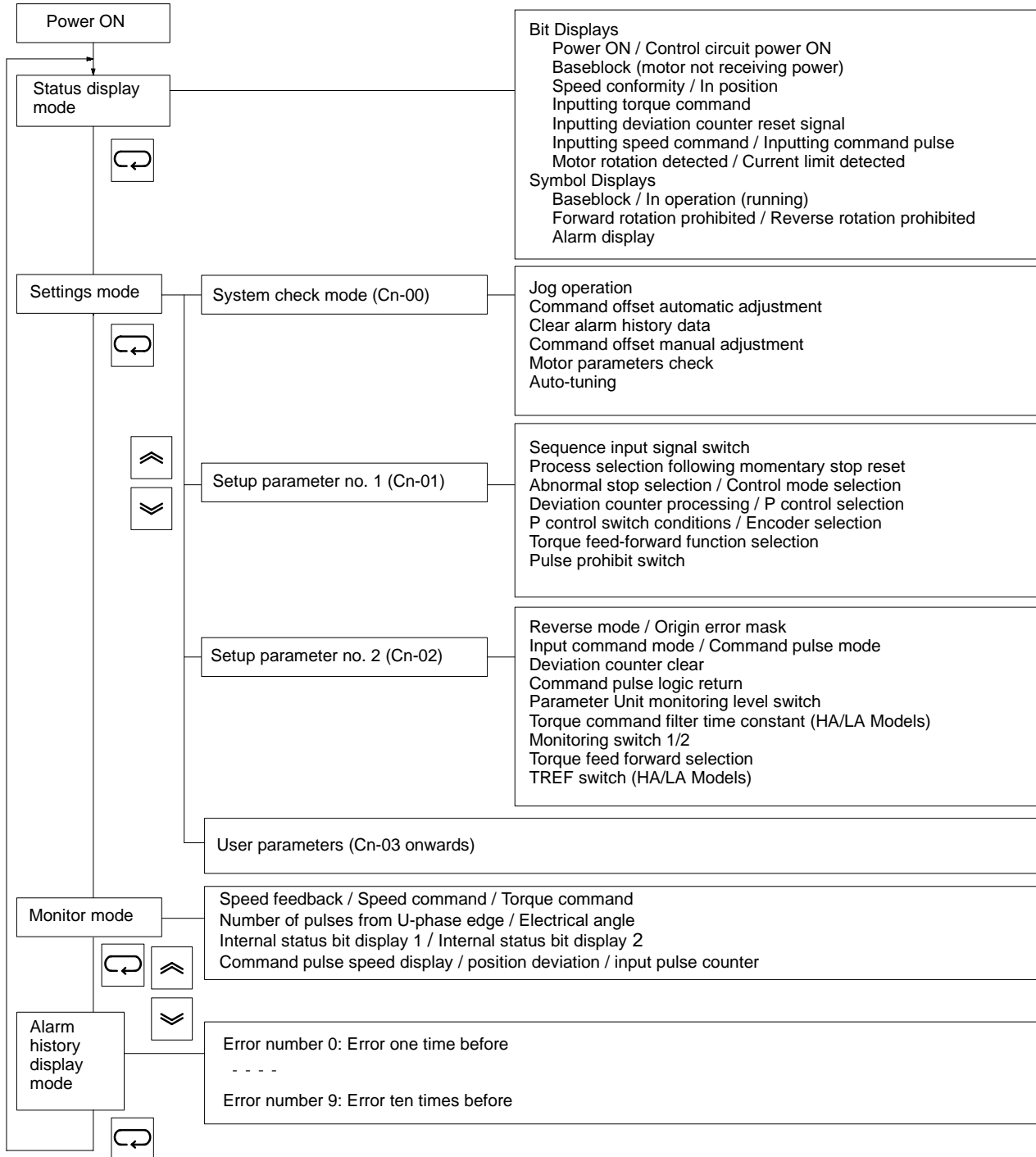

Note: Items which can be set and monitored differ according to the type of Servo Driver or Servomotor used. Refer to the User's Manual for details.

Using Parameter Units

■ Monitor Mode

Monitor no.	Monitor contents	Unit	Explanation
Un-00	Speed feedback	r/min	Displays actual rotational speed of motor.
Un-01	Speed command	r/min	Displays commands to speed loop when controlling via internally set speeds. "0" will be displayed when controlling with pulse trains.
Un-02	Torque command	%	The command to the current loop is displayed as 100% of the rated torque.
Un-03	Number of pulses from U-phase edge	Pulses	The number of pulses from the U-phase edge is displayed in units of encoder resolution.
Un-04	Electrical angle	Degrees	Displays the electrical angle of the motor.
Un-05	Internal status bit display 1	---	Displays Servo Driver internal information as either lit or not lit.
Un-06	Internal status bit display 2	---	
Un-07	Command pulse speed display	r/min	Displays the command pulse counter converted to a frequency (r/min).
Un-08	Position deviation (deviation counter)	Command units	Displays the pulse count (position deviation) remaining on the deviation counter in command units (based on input pulses).
Un-09	Input pulse counter	Command units	Counts and displays the input pulses.

■ Alarm Table

Display	Alarm code			Alarm ALM	Error detection function	Detection contents - cause of error	Remarks
	ALO1	ALO2	ALO3				
R.02	OFF	OFF	OFF	OFF	Parameter corruption	The checksum for the parameters read from the EEPROM does not match.	
R.04	OFF	OFF	OFF	OFF	Parameter setting error	Incorrect parameter setting.	
R.10	ON	OFF	OFF	OFF	Overcurrent	Overcurrent or overheating detected.	
R.31	ON	ON	OFF	OFF	Deviation counter overflow	The pulses remaining on the deviation counter exceed the deviation counter overflow level set in Cn-1E.	For position control only.
R.40	OFF	OFF	ON	OFF	Overvoltage	Main circuit DC voltage exceeded the allowable value.	
R.51	ON	OFF	ON	OFF	Over speed	Detected at 4,950 r/min.	
R.70	ON	ON	ON	OFF	Overload	Detected at reverse limit characteristics when the output torque exceeds 120% of the rated torque.	
R.b1	OFF	OFF	OFF	OFF	Command input reading error	The final signal from the AC Converter was not output within the fixed time.	For speed and torque control only.
R.C1	ON	OFF	ON	OFF	Runaway detected	Faulty power or encoder wiring.	
R.C2	ON	OFF	ON	OFF	Phase error detected	Connector not properly connected. Encoder not properly wired.	
R.C3	ON	OFF	ON	OFF	Encoder A or B phase wire disconnection	Either Phase A or Phase B signal was disconnected or short circuited.	
R.C4	ON	OFF	ON	OFF	Encoder S phase wire disconnection	Encoder S phase was disconnected or short circuited.	
R.F3	OFF	ON	OFF	OFF	Momentary power failure alarm	The power supply was re-started within the power retention period.	
R.99	OFF	OFF	OFF	ON	Alarm reset power supply turned on	This is history data only, and is not an alarm.	
CPFD0	OFF	OFF	OFF	OFF	Parameter Unit transmission error 1	Data could not be transmitted after the power supply was turned on. (It no longer exists in the alarm history.)	
CPFD1	---	---	---	---	Parameter Unit transmission error 2	Transmission timeout error (It no longer exists in the alarm history.)	

Note: "—" means indefinite.

Servomotor Specifications

■ Performance Specifications

200-VAC Servomotors

Item	Symbol IEC	Unit	With Incremental Encoder (R88M-)						
			U03030HA	U05030HA	U10030HA	U20030HA	U40030HA	U75030HA	
Rated output (see note 1)	P_r	W	30	50	100	200	400	750	
Rated torque (see note 1)	T_r	kgf•cm	0.974	1.62	3.25	6.49	13.0	24.3	
		N•m	0.095	0.159	0.318	0.637	1.27	2.39	
Rated rotational speed	ω_r	r/min	3000						
Momentary maximum rotational speed	ω_m	r/min	4500						
Momentary maximum torque (see note 1)	T_m	kgf•cm	2.92	4.87	9.75	19.5	39.0	72.9	
		N•m	0.29	0.48	0.96	1.91	3.82	7.10	
Momentary maximum/rated current ratio	I_m/I_r	%	310	317	322	300	308	316	
Rated current (see note 1)	I_r	A (rms)	0.42	0.60	0.87	2.0	2.6	4.4	
Momentary maximum current (see note 1)	I_m	A (rms)	1.3	1.9	2.8	6.0	8.0	13.9	
Rotor inertia INC (see note 4)	J_r	kgf•cm•s ²	0.21×10^{-4}	0.27×10^{-4}	0.41×10^{-4}	1.26×10^{-4}	1.95×10^{-4}	6.85×10^{-4}	
		kg•m ² (GD ² /4)	0.21×10^{-5}	0.26×10^{-5}	0.40×10^{-5}	1.23×10^{-5}	1.91×10^{-5}	6.71×10^{-5}	
Torque constant (see note 1)	K_t	kgf•cm/A	2.60	2.92	4.16	3.62	5.44	6.01	
		N•m/A	0.255	0.286	0.408	0.355	0.533	0.590	
Induced voltage constant (see note 1)	K_i	mV/ (r/min)	8.89	9.98	14.0	12.4	18.6	20.6	
Power rate (see note 1)	Q_p	kW/s	4.36	9.63	25.4	32.8	84.6	85.1	
Mechanical time constant	τ_m	ms	1.5	0.9	0.5	0.4	0.3	0.3	
Winding resistance	R_w	Ω	15.8	9.64	6.99	1.34	1.23	0.45	
Winding inductance	L_w	mH	23.1	16.9	13.2	7.2	7.9	5.7	
Electrical time constant	τ_e	ms	1.5	1.8	1.9	5.4	6.4	13	
Momentary allowable radial load INC (see note 4)	F_{mr}	kgf	19	19	19	50	50	75	
		N	186	186	186	490	490	735	
Momentary allowable thrust load INC (see note 4)	F_{mt}	kgf	13	13	13	18	18	40	
		N	127	127	127	176	176	392	
Allowable radial load INC (see note 4)	F_r	kgf	7	7	8	25	25	40	
		N	68	68	78	245	245	392	
Allowable thrust load INC (see note 4)	F_t	kgf	5.5	5.5	5.5	7.5	7.5	15	
		N	54	54	54	74	74	147	
Weight INC (see note 4)	Without brakes	m	kg	Approx. 0.3	Approx. 0.4	Approx. 0.5	Approx. 1.1	Approx. 1.7	Approx. 3.4
	With brakes		kg	Approx. 0.6	Approx. 0.7	Approx. 0.8	Approx. 1.6	Approx. 2.2	Approx. 4.3
Corresponding Servo Driver (R88D-)	Analog output	UA02HA		UA03HA	UA04HA	UA08HA	UA12HA	UA20HA	
	Pulse train output	UP02HA		UP03HA	UP04HA	UP08HA	UP12HA	UP20HA	
Brake specifications (see note 2)	Brake inertia	J_b	kgf•cm•s ²	0.09×10^{-4}			0.59×10^{-4}		1.43×10^{-4}
			kg•m ² (GD ² /4)	0.09×10^{-5}			0.58×10^{-5}		1.40×10^{-5}
	Magnetized voltage	U_b	V	24 VDC \pm 10% (no polarity)					
	Power consumption (at 20°C)	P_b	W	6			6.5	6	
	Current consumption (at 20°C)	I_b	A	0.25			0.27	0.25	
	Static friction torque	T_b	kgf•cm	2.0 min.		3.5 min.	15.0 min.		25.0 min.
			N•m	0.2 min.		0.34 min.	1.5 min.		2.5 min.
	Absorption time (see note 3)	f_{ba}	ms	40 max.		60 max.	100 max.		200 max.
	Release time (see note 3)	f_{br}	ms	20 max.		30 max.	40 max.		50 max.
	Backlash	---	---	$\pm 1^\circ$ (reference value)					
Rating	---	---	Continuous						
Insulation grade	---	---	Type F						

Servomotor Specifications

100-VAC Servomotors

Item	Symbol IEC	Unit	With Incremental Encoder (R88M-)					
			U03030LA	U05030LA	U10030LA	U20030LA	U30030LA	
Rated output (see note 1)	P_r	W	30	50	100	200	300	
Rated torque (see note 1)	T_r	kgf·cm	0.974	1.62	3.25	6.49	9.74	
		N·m	0.095	0.159	0.318	0.637	0.954	
Rated rotational speed	ω_r	r/min	3000					
Momentary maximum rotational speed	ω_m	r/min	4500					
Momentary maximum torque (see note 1)	T_m	kgf·cm	2.92	4.87	9.75	19.5	38.0	
		N·m	0.29	0.48	0.96	1.91	3.72	
Momentary maximum/rated current ratio	I_m/I_r	%	317	322	323	311	400	
Rated current (see note 1)	I_r	A (rms)	0.63	0.9	2.2	2.7	3.7	
Momentary maximum current (see note 1)	I_m	A (rms)	2.0	2.9	7.1	8.4	14.8	
Rotor inertia INC (see note 4)	J_r	kgf·cm·s ²	0.21×10^{-4}	0.27×10^{-4}	0.41×10^{-4}	1.26×10^{-4}	1.95×10^{-4}	
		kg·m ² (GD ² /4)	0.21×10^{-5}	0.26×10^{-5}	0.40×10^{-5}	1.23×10^{-5}	1.91×10^{-5}	
Torque constant (see note 1)	K_t	kgf·cm/A	1.72	1.98	1.59	2.60	2.85	
		N·m/A	0.168	0.194	0.156	0.255	0.279	
Induced voltage constant (see note 1)	K_i	mV/ (r/min)	5.87	6.79	5.43	8.9	9.74	
Power rate (see note 1)	Q_p	kW/s	4.36	9.63	25.4	32.8	47.3	
Mechanical time constant	τ_m	ms	1.6	0.9	0.6	0.4	0.3	
Winding resistance	R_w	Ω	7.22	4.34	1.22	0.706	0.435	
Winding inductance	L_w	mH	9.7	6.9	2.0	4.0	2.3	
Electrical time constant	τ_e	ms	1.3	1.6	1.6	5.7	5.3	
Momentary allowable radial load INC (see note 4)	F_{mr}	kgf	19	19	19	50	50	
		N	186	186	186	490	490	
Momentary allowable thrust load INC (see note 4)	F_{mt}	kgf	13	13	13	18	18	
		N	127	127	127	176	176	
Allowable radial load INC (see note 4)	F_r	kgf	7	7	8	25	25	
		N	68	68	78	245	245	
Allowable thrust load INC (see note 4)	F_t	kgf	5.5	5.5	5.5	7.5	7.5	
		N	54	54	54	74	74	
Weight INC (see note 4)	Without brakes	m	kg	Approx. 0.3	Approx. 0.4	Approx. 0.5	Approx. 1.1	Approx. 1.7
	With brakes		kg	Approx. 0.6	Approx. 0.7	Approx. 0.8	Approx. 1.6	Approx. 2.2
Corresponding Servo Driver (R88D-)	Analogue output	UA03LA UA04LA UA10LA UA12LA UA15LA						
	Pulse train output	UP03LA UP04LA UP10LA UP12LA UP15LA						
Brake specifications (see note 2)	Brake inertia	J_b	kgf·cm·s ²	0.09×10^{-4}			0.59×10^{-4}	
			kg·m ² (GD ² /4)	0.09×10^{-5}			0.58×10^{-5}	
	Magnetized voltage	U_b	V	24 VDC \pm 10% (no polarity)				
	Power consumption (at 20°C)	P_b	W	6			6.5	
	Current consumption (at 20°C)	I_b	A	0.25			0.27	
	Static friction torque	T_b	kgf·cm	2.0 min.		3.5 min.	15.0 min.	
			N·m	0.2 min.		0.34 min.	1.5 min.	
	Absorption time (see note 3)	t_{ba}	ms	40 max.		60 max.	100 max.	
	Release time (see note 3)	t_{br}	ms	20 max.		30 max.	40 max.	
	Backlash	---		$\pm 1^\circ$ (reference value)				
Rating	---		Continuous					
Insulation grade	---		Type F					

- Note:
1. Values for these items, as well as those for torque, the rotational speed characteristics, are the values at an armature winding temperature of 100°C, combined with the Servo Driver. Other values are at normal conditions (20°C, 65%). The momentary maximum torque value is the reference value.
 2. The brakes installed in the Servomotors have non-magnetized operation. (The magnetic brake is released when a magnetic current is applied.)
 3. The operation time measurement is the measured value with a surge killer (CR50500, by Okaya Electric Industrial Co.) installed.
 4. INC: Servomotor with Incremental Encoder attached.
 5. The magnetic brakes installed in Servomotors with brakes are status-holding brakes. The magnetic brake is not meant to be used for braking. Using it for braking will damage it. During Servomotor operation, be sure to release the magnetic brake by applying a magnetic voltage.
 6. Absolutely do not impact the Servomotor or the output shaft by striking with an implement such as a hammer. Doing so will damage the Servomotor and encoder bearings.

Servomotor Specifications

■ General Specifications

Item	Specifications
Operating ambient temperature	0°C to 40°C
Operating ambient humidity	20% to 80% RH (with no condensation)
Storage ambient temperature	-10°C to 75°C
Storage ambient humidity	20% to 80% RH (with no condensation)
Storage and operating atmosphere	No corrosive gasses.
Vibration resistance	10 to 150 Hz in X, Y, and Z directions with 0.2-mm double amplitude; acceleration: 2.5G {24.5 m/s ² } max.; time coefficient: 8 min; 4 sweeps (see note 1)
Impact resistance	Acceleration 10G {98 m/s ² } max., in X, Y, and Z directions, three times
Insulation resistance	Between power line terminals and case: 10 MΩ min. (500 VDC megger)
Dielectric strength	Between power line terminals and case: 1,500 VAC for 1 min (10 mA max.) at 50/60 Hz (JEC2121)
Run position	All directions
Insulation grade	Type B (JIS C4004)
Structure	Totally-enclosed self-cooling
Protective structure	IP-42 (JEM1030) (Cannot be used in environment with water-soluble cutting fluids.) (See note 2)
Vibration grade	V-15 (JEC2121)
Mounting method	Flange-mounting

- Note:
1. Vibration may be amplified due to sympathetic resonance of machinery, so use the Servomotor Driver under conditions which will not exceed 2G {19.6 m/s²} over a long period of time.
 2. The drip-proofing specifications are special specifications covered by IP-44. (Models with drip-proof specifications provide drip-proofing on Servomotors with oil seals.)
 3. The above items reflect individual evaluation testing. The results may differ under compounded conditions.
 4. The Servomotor cannot be used in a misty atmosphere.

Servomotor Shaft Tolerance Load

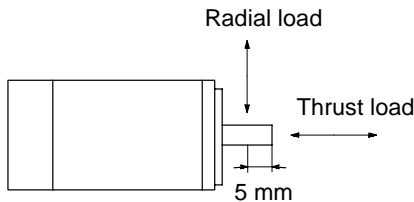

- The allowable radial load is the value at a point 5 mm from the end of the shaft.
- The allowable radial and thrust loads are values determined with a service life of 20,000 hours taken as a criteria.

Radiant Heat Conditions

When the AC Servomotor is operated continuously at a rated current, a radiant heat board, as noted here, must be fitted to the Servomotor flange. 30 to 750 W: t6 × 250 mm angle aluminium board or the above equivalent.

Torque and Rotation Speed Characteristics

R88M-U03030HA
(N·m)(kgf·cm)

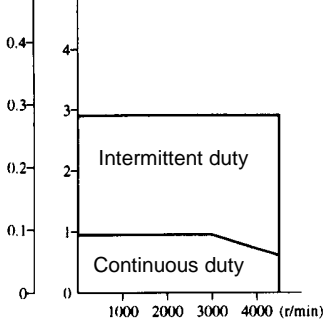

R88M-U05030HA
(N·m)(kgf·cm)

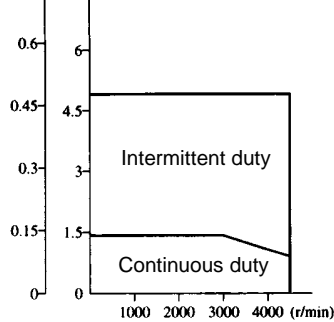

R88M-U10030HA
(N·m)(kgf·cm)

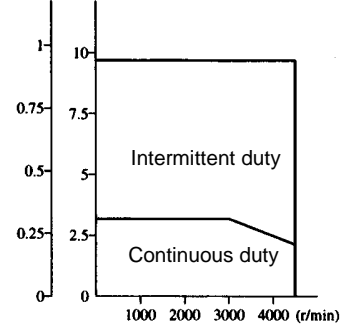

R88M-U20030HA
(N·m)(kgf·cm)

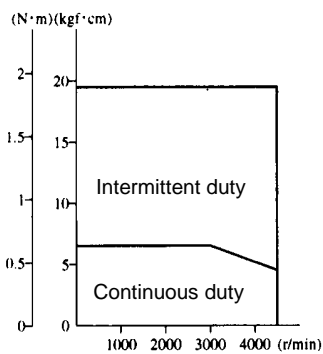

R88M-U40030HA
(N·m)(kgf·cm)

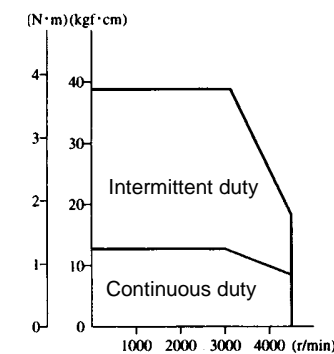

R88M-U75030HA
(N·m)(kgf·cm)

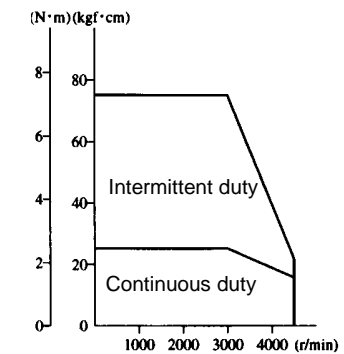

■ 100 VAC Specifications (With 3-m Standard Cable and 100-VAC Input)

R88M-U03030LA
(N·m)(kgf·cm)

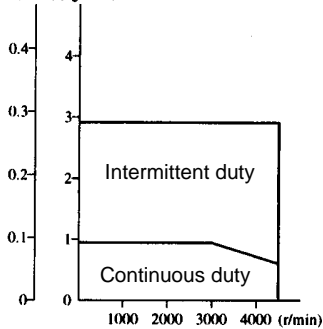

R88M-U05030LA
(N·m)(kgf·cm)

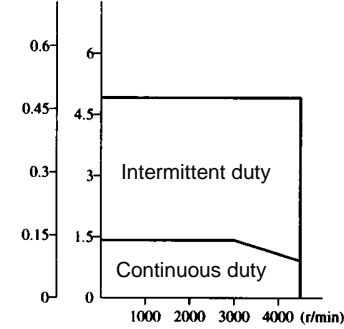

R88M-U10030LA
(N·m)(kgf·cm)

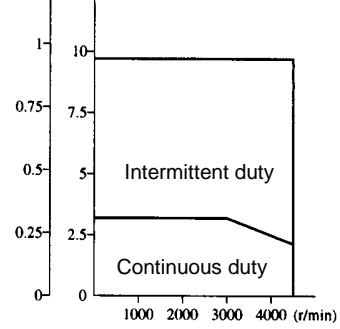

R88M-U20030LA
(N·m)(kgf·cm)

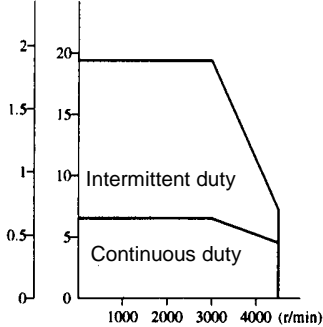

R88M-U30030LA
(N·m)(kgf·cm)

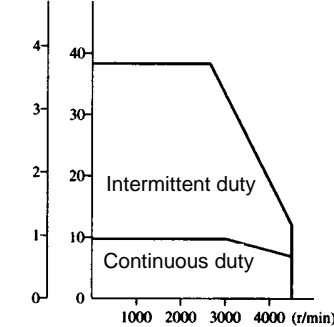

Servo Driver Specifications

■ General Specifications (For 30- to 750-W Models)

Item	Specifications
Operating ambient temperature	0°C to 55°C
Operating ambient humidity	35% to 85% RH (with no condensation)
Storage ambient temperature	-10°C to 75°C
Storage ambient humidity	35% to 85% RH (with no condensation)
Storage and operating atmosphere	No corrosive gasses.
Vibration resistance	10 to 55 Hz in X, Y, and Z directions with 0.10-mm double amplitude; acceleration: 0.5 G (4.9 m/s ²) max.; time coefficient: 8 min; 4 sweeps (See note 1.)
Impact resistance	Acceleration 2 G (19.6 m/s ²) max., in X, Y, and Z directions, three times
Insulation resistance	Between power line terminals and case: 5 MΩ min. (at 1,000 VDC)
Dielectric strength	Between power line terminals and case: 1,000 VAC for 1 min (20 mA max.) at 50/60 Hz
Protective structure	Built into panel.

- Note:
1. Vibration may be amplified due to sympathetic resonance of machinery, so use the Servomotor under conditions which will not exceed 0.5 G (4.9 m/s²) over a long period of time.
 2. The above items reflect individual evaluation testing. The results may differ under compounded conditions.
 3. Absolutely do not conduct a withstand voltage test or other Megger tester tests on the Servo driver. If such tests are conducted, internal elements may be damaged.
 4. Depending on the operating conditions, some Servo Driver parts will require maintenance. Refer to the relevant operation manual for details.

■ Performance Specifications (30- to 750-W Analog Input Models)

Model	200 V						100 V				
	R88D- -UA02HA	R88D- -UA03HA	R88D- -UA04HA	R88D- -UA08HA	R88D- -UA12HA	R88D- -UA20HA	R88D- -UA03LA	R88D- -UA04LA	R88D- -UA10LA	R88D- -UA12LA	R88D- -UA15LA
Continuous output current (0-P)	0.6 A	0.85 A	1.2 A	2.8 A	3.7 A	6.2 A	0.9 A	1.3 A	3.1 A	3.8 A	4.8 A
Momentary maximum output current (0-P)	1.8 A	2.7 A	4.0 A	8.5 A	11.3 A	19.7 A	2.8 A	4.1 A	10 A	12 A	15 A
Input power supply	Single-phase 200/230 VAC (170 to 253 V) 50/60 Hz						Single-phase 100/115 VAC (85 to 127 V) 50/60 Hz				
Control method	All-digital servo										
Speed feedback	Incremental encoder (magnetic), 2,048 pulses/revolution										
Applicable load inertia INC (see note)	Maximum of 30 times motor's rotor inertia					Maximum of 20 times motor's rotor inertia	Maximum of 30 times motor's rotor inertia				Maximum of 20 times motor's rotor inertia
Inverter method	PWM method based on IGBT										
PWM frequency	11 kHz					7.8 kHz	11 kHz				7.8 kHz
Applicable Servomotor INC (see note)	R88M- U03030H A	R88M- U05030HA	R88M- U10030HA	R88M- U20030HA	R88M- U40030HA	R88M- U75030HA	R88M- U03030LA	R88M- U05030LA	R88M- U10030LA	R88M- U20030LA	R88M- U30030LA
Applicable Servomotor wattage	30 W	50 W	100 W	200 W	400 W	750 W	30 W	50 W	100 W	200 W	300 W
Weight	Approx. 0.9 kg				Approx. 1.2 kg	Approx. 1.5 kg	Approx. 0.9 kg			Approx. 1.2 kg	Approx. 1.5 kg
Capacity	Speed control range	1:5000									
	Speed fluctuation rate (load characteristic)	0.01% at 0 to 100% (at rated rotation speed)									
	Speed fluctuation rate (voltage characteristic)	0% at input voltage of 170 to 253 VAC					0% at input voltage of 85 to 127 VAC				
	Speed fluctuation rate (temperature characteristic)	±0.2% max. at 0 to 50°C									
	Frequency characteristics	250 Hz (at the same load as the rotor inertia)									
	Torque control reproducibility	±2.0%									
	Acceleration time setting	0 to 10 s (Acceleration and deceleration times are set separately)									

(This table continues on the next page.)

Servo Driver Specifications

Specifications Table - continued from previous page

Input signal	Speed command voltage	±2 to 10 VDC (motor rotation by +command) / rated rotation speed Input impedance: Approx. 30 kΩ; circuit time constant: Approx. 47 μs
	Torque command voltage	±1 to 10 VDC / rated torque Input impedance: Approx. 30 kΩ; circuit time constant: Approx. 47 μs
	Sequence input	Run command, gain deceleration, forward/reverse current limit, forward/reverse drive prohibit, alarm reset, 24-VDC, 5-mA photocoupler input, external power supply: 24±1 VDC, 50 mA min.
Output signal	Position feedback output	A-, B-, Z-phase line driver output (EIA RS-422A) A-phase and B-phase (dividing rate setting): 16 to N pulses/revolution, N=2,048 (incremental) Z-phase: 1 pulse/revolution
	Speed monitor output	0.5 V/1000 r/min
	Current monitor output	0.5 V/100%
	Sequence output	Alarm output, alarm code output, motor rotation detection, brake interlock, speed conformity, open collector output, 30 VDC, 50 mA (except for alarm code output, which is 30 VDC, 20 mA)
Dynamic brake stopping	Operates when the power supply turns off, a servo alarm is generated or an overrun occurs.	
Protective functions	Overcurrent, grounding, overload, overvoltage, overspeeding, A/D errors, transmission errors, encoder errors, overrun prevention	

Note: INC: Servomotor with Incremental Encoder attached.

■ Performance Specifications (30- to 750-W Pulse Train Input Models)

Model	200 V						100 V					
	R88D-UP02HA	R88D-UP03HA	R88D-UP04HA	R88D-UP08HA	R88D-UP12HA	R88D-UP20HA	R88D-UP03LA	R88D-UP04LA	R88D-UP10LA	R88D-UP12LA	R88D-UP15LA	
Continuous output current (0-P)	0.6 A	0.85 A	1.2 A	2.8 A	3.7 A	6.2 A	0.9 A	1.3 A	3.1 A	3.8 A	4.8 A	
Momentary maximum output current (0-P)	1.8 A	2.7 A	4.0 A	8.5 A	11.3 A	19.7 A	2.8 A	4.1 A	10 A	12 A	15 A	
Input power supply	Single-phase 200/230 VAC (170 to 253 V) 50/60 Hz						Single-phase 100/115 VAC (85 to 127 V) 50/60 Hz					
Control method	All-digital servo											
Speed feedback	Incremental encoder (magnetic), 2,048 pulses/revolution											
Applicable load inertia	Maximum of 30 times motor's rotor inertia					Maximum of 20 times motor's rotor inertia	Maximum of 30 times motor's rotor inertia				Maximum of 20 times motor's rotor inertia	
Inverter method	PWM method based on IGBT											
PWM frequency	11 kHz					7.8 kHz	11 kHz				7.8 kHz	
Applicable Servomotor	R88M-U03030HA	R88M-U05030HA	R88M-U10030HA	R88M-U20030HA	R88M-U40030HA	R88M-U75030HA	R88M-U03030LA	R88M-U05030LA	R88M-U10030LA	R88M-U20030LA	R88M-U30030LA	
Applicable Servomotor wattage	30 W	50 W	100 W	200 W	400 W	750 W	30 W	50 W	100 W	200 W	300 W	
Weight	Approx. 0.9 kg					Approx. 1.2 kg	Approx. 1.5 kg	Approx. 0.9 kg			Approx. 1.2 kg	Approx. 1.5 kg
Capacity	Maximum response pulse frequency	200 kpps										
	Position loop gain	1 to 500 (1/s)										
	Electrical gear function	Electrical gear ratio range: $0.01 \leq (G1/G2) \leq 100$ (G1, G2 = 1 to 65, 535)										
	Positioning completed width	0 to 250 (command units)										
	Feed forward compensation	0 to 100% of the speed command (pulse frequency)										
	Bias setting	0 to 450 r/min										
	Position accel/ decel time constant setting	0 to 64 ms (acceleration and deceleration are set the same)										

(This table continues on the next page.)

Servo Driver Specifications

Specifications Table - continued from previous page

Input signal	Position command pulse input (See note.)	TTL line driver input photo isolation input power supply 6 mA to 3 V. Feed pulse/forward, reverse signal, forward pulse/reverse pulse, 90° disparity (A-, B-phase) signal.
	Deviation counter reset	TTL line driver input photo isolation input power supply 6 mA to 3 V.
	Sequence input	Run command, gain deceleration, forward/reverse current limit, forward/reverse drive prohibit, alarm reset, 24-VDC, 5-mA photocoupler input, external power supply: 24±1 VDC, 50 mA min.
Output signal	Position feedback output	A-, B-, Z-phase line driver output (EIA RS-422A) A-phase and B-phase (dividing rate setting): 16 to 2,048 pulses/revolution Z-phase: 1 pulse/revolution
	Speed monitor output	0.5 V/1000 r/min
	Current monitor output	0.5 V/100%
	Sequence output	Alarm output, alarm code output, motor rotation detection, brake interlock, positioning complete, open collector output, 30 VDC, 50 mA (except for alarm code output, which is 30 VDC, 20 mA)
Dynamic brake stopping		Operates when the power supply turns off, a servo alarm is generated or an overrun occurs.
Protective functions		Overcurrent, grounding, overload, overvoltage, overspeeding, overrun prevention, transmission errors, encoder errors, deviation counter overrun

Note: Ensure that the input pulse width meets the following conditions.

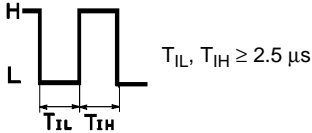

■ U-Series Servomotors and Servo Drivers Are UL and cUL Approved

Standard	Model	Applicable Standard	File No.
UL	AC Servo Driver	UL508C	E179149
	AC Servomotor	UL1004	E179189
cUL	AC Servo Driver	cUL C22.2 No. 14	E179149
	AC Servomotor	cUL C22.2 No. 100	E179189

Options Specifications

■ Regeneration Unit Specifications (For 30- to 750-W Models)

General Specifications

Item	Specifications
Operating ambient temperature	0°C to 55°C
Storage ambient temperature	-10°C to 75°C
Operating ambient humidity	35% to 85% RH (with no condensation)
Storage ambient humidity	35% to 85% RH (with no condensation)
Storage and operating atmosphere	No corrosive gasses.
Vibration resistance	0.5 G {4.9 m/s ² } max.
Impact resistance	Acceleration 2 G {19.6 m/s ² } max.

Performance Specifications

Model	R88A-RG08U
Regeneration operating voltage	380 V _{DC}
Regeneration processing current	8 A _{DC}
Average regeneration power	12 W (internal resistance: 50 Ω, 60 W)
Error detection function	Regeneration resistance disconnection, regeneration transistor damage, overvoltage
Alarm output	1b contact (open contact at time of protective function operation) (200 VAC drive possible.)
Weight	Approx. 1 kg

Indicator LED Specifications

Item	Specifications
POWER	Lit while power flows through PN terminal.
REGEN	Lit during regeneration operation.
ALARM-REGEN	Lit for regeneration resistance disconnection or regeneration transistor damage.
ALARM-OV	Lit when overvoltage occurs.

- Note:
1. When the error detection function operates, an alarm is output from the Unit.
 2. Create a sequence so that the power supply (R-T) to the Servo Driver is cut off when an alarm is generated.
 3. When the error detection function operates and the Servo Driver's power supply is cut off, the Regeneration Unit won't be restored to its normal status until 2 to 3 seconds have elapsed, even if the power supply is turned on again. (Normal status is restored after the electrolytic capacitor in the Servo Driver has been discharged and the voltage between signals P and N drops.)

■ Parameter Unit Specifications

General Specifications

Item	Specifications
Operating ambient temperature	0°C to 55°C
Storage ambient temperature	-10°C to 75°C
Operating ambient humidity	35% to 85% RH (with no condensation)
Storage ambient humidity	35% to 85% RH (with no condensation)
Storage and operating atmosphere	No corrosive gasses.
Vibration resistance	0.5 G {4.9 m/s ² } max.
Impact resistance	Acceleration 2 G {19.6 m/s ² } max.

Performance Specifications

Item	R88A-PR02U	R88A-PR03U	
Type	Handy type	Mounted type	
Accessory cable	1 m	(Connected by connectors.)	
Connectors	7910-7500SC (10 pins)	D sub-connector (9 pins)	
Display	7-segment LED, 5 digits		
Weight	Approx. 0.18 kg	Approx. 0.02 kg	
Communications specifications	Standard	RS-232C	
	Communications method	Asynchronous (ASYNC)	
	Baud rate	2,400 bps	
	Start bits	1 bit	
	Data	8 bits	
	Parity	None	
Errors detected by Parameter Unit	Dis-play	CPF00	Cannot transmit even after 5 seconds have elapsed since power supply was turned on.
		CPF01	A BCC error or faulty reception data has occurred for five consecutive times, or a time overrun (1 s) has occurred for three consecutive times.

External Dimensions

Unit: mm

■ AC Servomotors

• 30 to 100 W **INC**

30 W R88M-U03030HA/U03030LA

50 W R88M-U05030HA/U05030LA

100 W R88M-U10030HA/U10030LA

Model	L	LL	S
R88M-U03030HA	94.5	69.5	6
R88M-U03030LA			
R88M-U05030HA	102	77	6
R88M-U05030LA			
R88M-U10030HA	119.5	94.5	8
R88M-U10030LA			

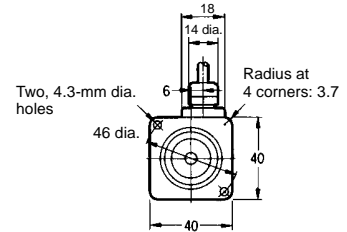
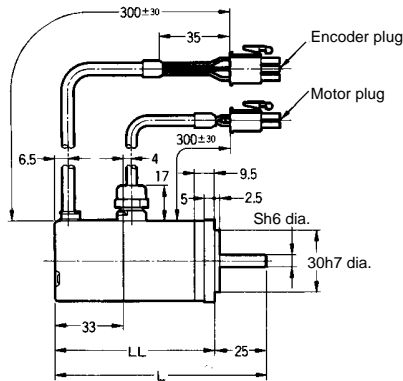

• 30 to 100 W **INC With B**

30 W R88M-U03030HA-B/U03030LA-B

50 W R88M-U05030HA-B/U05030LA-B

100 W R88M-U10030HA-B/U10030LA-B

Model	L	LL	LB	S
R88M-U03030HA-B	126	101	31.5	6
R88M-U03030LA-B				
R88M-U05030HA-B	133.5	108.5	31.5	6
R88M-U05030LA-B				
R88M-U10030HA-B	160	135	40.5	8
R88M-U10030LA-B				

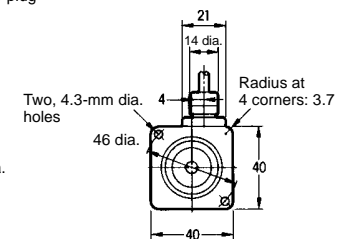
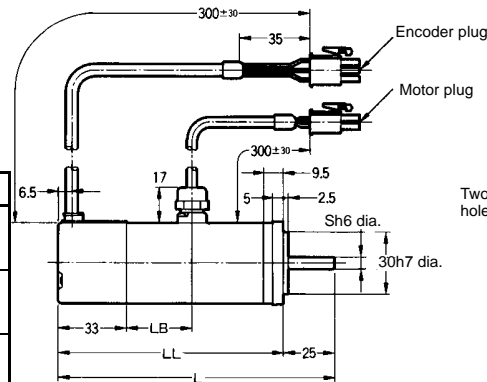

• 200 to 400 W **INC**

200 W R88M-U20030HA/U20030LA

300 W R88M-U30030LA

400 W R88M-U40030HA

Model	L	LL
R88M-U20030HA	126.5	96.5
R88M-U20030LA		
R88M-U30030LA	154.5	124.5
R88M-U40030HA		

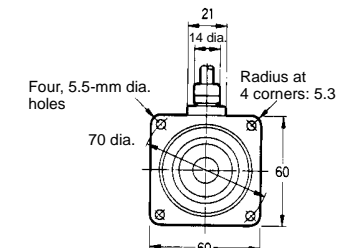
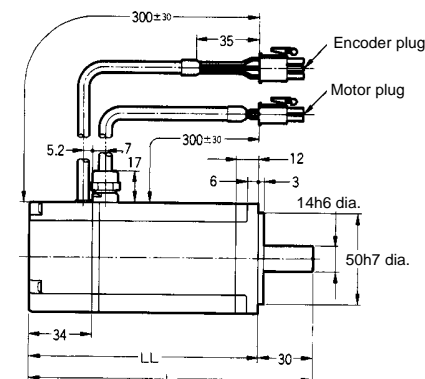

Note: **INC** : Incremental Encoder Attached

With B : With brakes

External Dimensions

Unit: mm

• **200 to 400 W INC With B**

200 W R88M-U20030HA-B/U20030LA-B

300 W R88M-U30030LA-B

400 W R88M-U40030HA-B

Model	L	LL
R88M-U20030HA-B	166	136
R88M-U20030LA-B		
R88M-U30030LA-B	194	164
R88M-U40030HA-B		

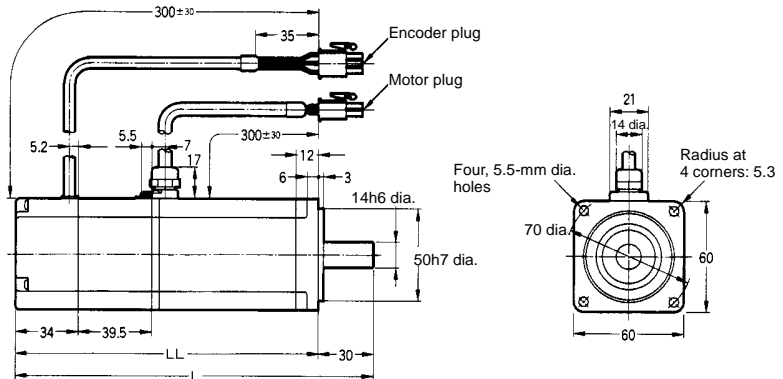

• **750 W INC**

R88M-U75030HA

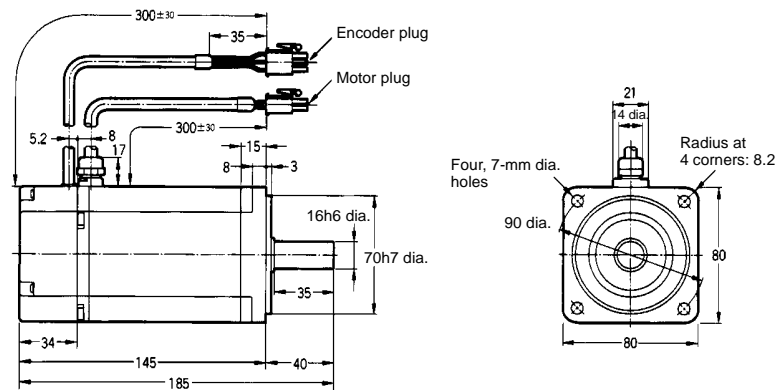

• **750 W INC With B**

R88M-U75030HA-B

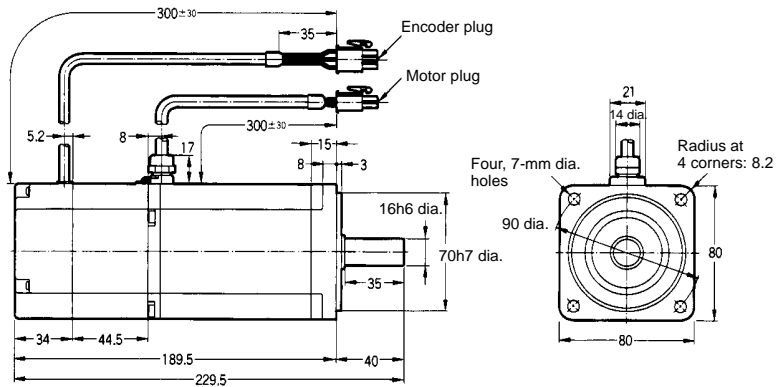

Note: **INC** : Incremental Encoder Attached

With B : With brake

External Dimensions

Unit: mm

■ AC Servo Drivers

• 200 VAC, 30 to 200 W

R88D-UA02HA/UA03HA/UA04HA/UA08HA

R88D-UP02HA/UP03HA/UP04HA/UP08HA

• 100 VAC, 30 to 100 W

R88D-UA03LA/UA04LA/UA10LA

R88D-UP03LA/UP04LA/UP10LA

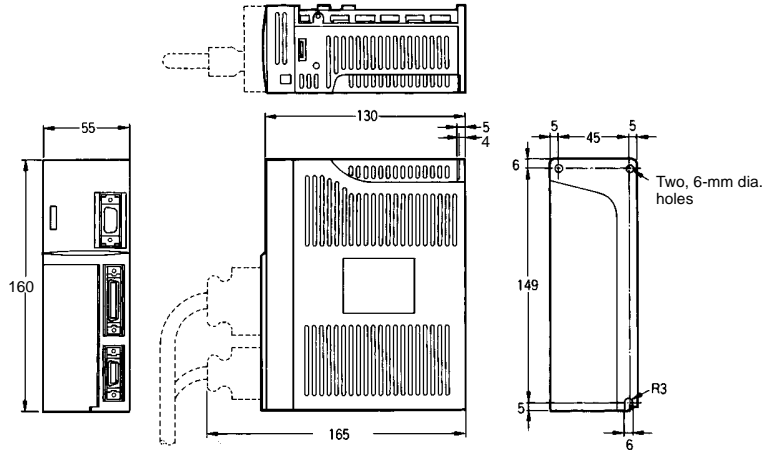

• 200 VAC, 400 W

R88D-UA12HA

R88D-UP12HA

• 100 VAC, 200 W

R88D-UA12LA

R88D-UP12LA

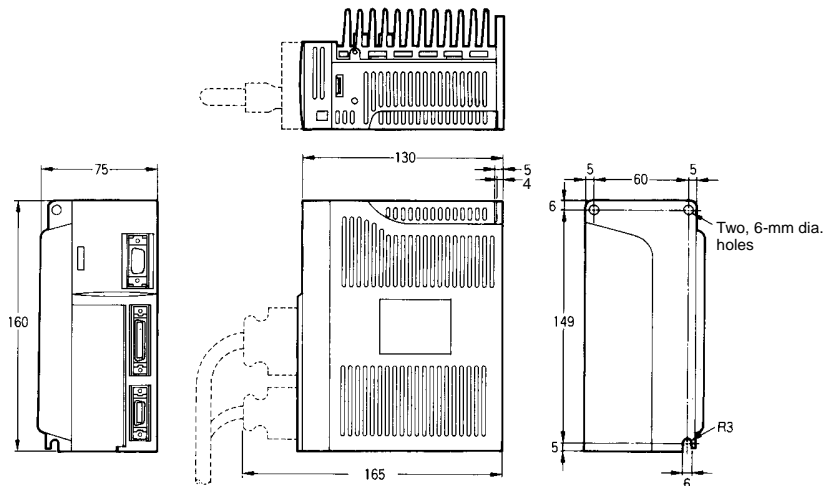

• 200 VAC, 750 W

R88D-UA20HA

R88D-UP20HA

• 100 VAC, 300 W

R88D-UA15LA

R88D-UP15LA

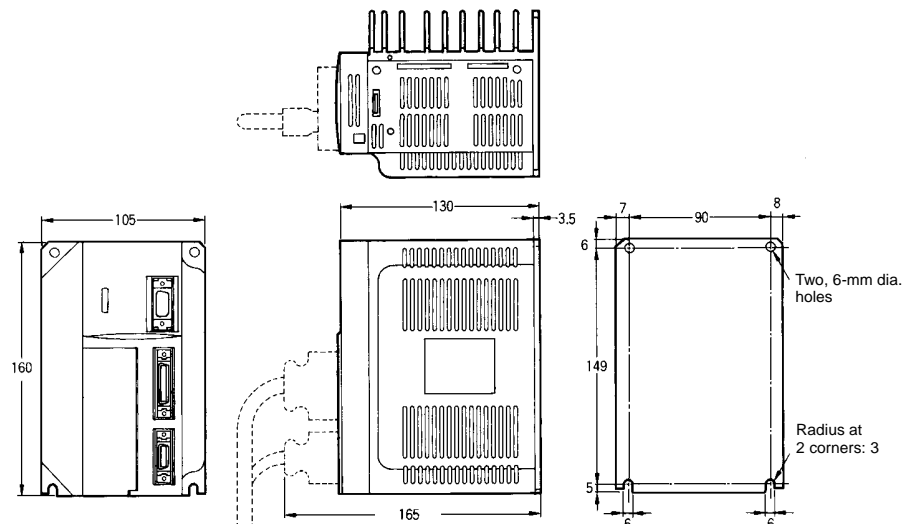

External Dimensions

Unit: mm

■ Regeneration Unit

- R88A-RG08UA

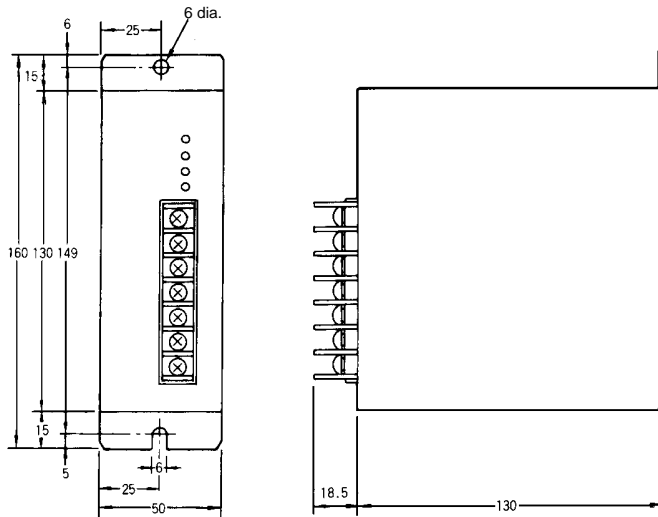

■ Parameter Units

- R88A-PR02U

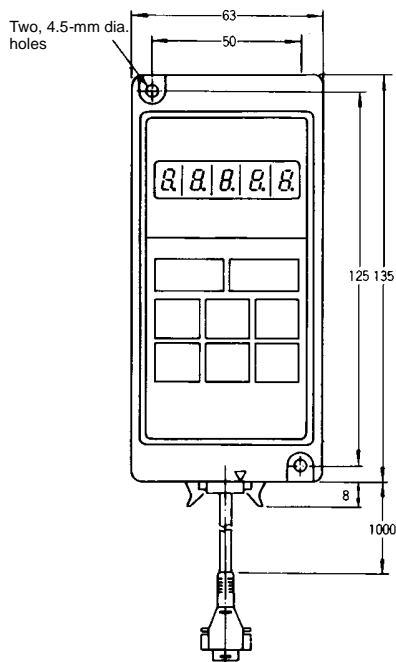

- R88A-PR03U

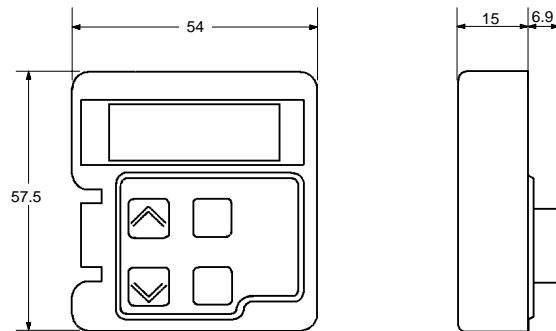

Terminal and Connector Functions (30 to 750 W)

Terminal Block Specifications

Signal	Name	Function	
R T	Power supply input	Power input terminal for the main circuit and control circuit. (The voltage differs according to the model type.)	
P N	Main circuit DC output	These are the connection terminals for the Regeneration Unit (R88A-RG08U). Connect these when the regeneration energy is high.	
U	Servomotor U-phase output	Red	These are the terminals for outputs to the Servomotor.
V	Servomotor V-phase output	White	
W	Servomotor W-phase output	Blue	
⏏	Frame ground	Green	This is the connection terminal. Use a class-3 or higher ground. It is used in common for Servomotor output and power supply input.

Encoder Input CN2 (Incremental Encoder)

Pin no.	Signal	Name	Interface
1, 2, 3	E0V	Encoder power supply GND	Power supply outlet for encoder: 5 V, 120 mA.
4, 5, 6	E5V	Encoder power supply +5 V	
7	DIR	Rotation direction switch input	Connects to GND when reverse rotation is executed by + input.
8, 9, 10, 11, 12, 13	NC	Not used	Do not connect.
14	S+	Encoder + S-phase input	Line driver input (conforming to EIA RS-422A) (Input impedance: 220 Ω)
15	S-	Encoder - S-phase input	
16	A+	Encoder + A-phase input	Line driver input (conforming to EIA RS-422A) (Input impedance: 220 Ω)
17	A-	Encoder - A-phase input	
18	B+	Encoder + B-phase input	Line driver input (conforming to EIA RS-422A) (Input impedance: 220 Ω)
19	B-	Encoder - B-phase input	
20	FG	Shielded ground	Cable shielded ground.

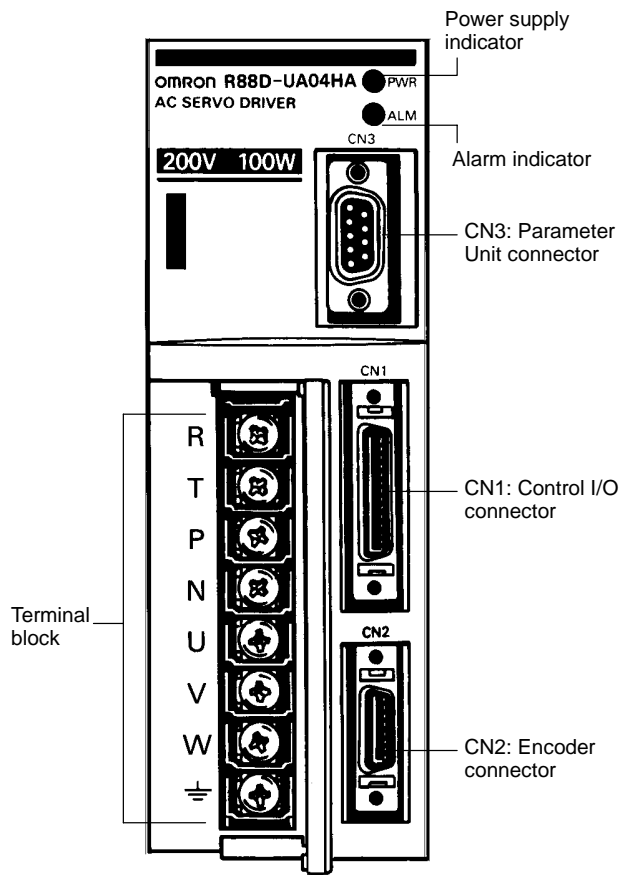

Terminal and Connector Functions (30 to 750 W)

■ Control Input CN1 (Analog Input/Pulse Train Input)

Pin no.	Signal	Name	Function, Interface	Specified driver type: A: R88D-UA P: R88D-UP
1	TREF	Torque command input	±1 to ±10 V / rated torque Changeable by means of user parameter Cn-13 torque command scale.	A
2	AGND	Torque command input ground		
3	REF	Speed command input	±2 to ±10 V / rated torque Changeable by means of user parameter Cn-03 speed command scale.	
4	AGND	Speed command input ground		
5	-	-	Do not connect.	
6	-	-		
1	+PULS/CW/A	Feed pulse, reverse pulse, or 90° phase difference pulse (A-phase) Forward/reverse signal, forward rotation pulse, or 90° phase difference pulse (B-phase)	Line driver input 6 mA to 3 V. Setup parameter Cn-02 bits 3, 4, and 5 allow feed pulse/forward, reverse signal, forward pulse/reverse pulse, 90° phase difference pulse (A-, B-phase) signal (X1, X2, X4) to be switched. Maximum response frequency: 200 kpps	P
2	-PULS/CW/A			
3	+SIGN/CCW/B			
4	-SIGN/CCW/B			
5	+ECRST	+ deviation counter reset	Line driver input 6 mA to 3 V. Resets the deviation counter when command input is prohibited.	
6	-ECRST	- deviation counter reset		
11	PCL/SPD1	Forward rotation current limit input / Speed selection command 1 input	Forward/reverse rotation current limit (PCL/NCL) when setup parameter Cn-02 bit no. 2 = 0. (ON: Current limit) Internal setting speed (Cn-1F, 20, 21) selector switch when setup parameter Cn-02 bit no. 2 = 1.	A/P
12	NCL/SPD2	Forward rotation current limit input / Speed selection command 2 input		
13	+24VIN	+24-V power supply input for control DC	Power supply for pin nos. 11, 12, 14, 15, 16, 17, 18; +24-V input	A/P
14	RUN	Run command input	ON: Servo ON, when setup parameter Cn-01 bit no. 0 = 0. When setup parameter Cn-01 bit no. 0 = 1, this signal is not used. (Automatically set to Servo ON.)	A/P
15 (See the next page for more info on this Pin No.)	MING/PLOCK TVSEL/RDIR	Gain deceleration input	ON: Decrease speed loop gain, when setup parameter Cn-01 bit nos. b, A = 0, 0.	A
		Position lock command input	When setup parameter Cn-01 bit nos. b, A = 0, 1, then, when this bit is ON, position lock goes in effect if the motor rotation speed is no more than the position lock rotation speed (Cn-0F).	
		Torque / Speed control switch input	When setup parameter Cn-01 bit nos. b, A = 1, 1, then, when this bit is ON, the mode changes from the torque command (TREF) mode to the speed command (REF) mode. When in torque command mode, speed command (REF) inputs become forward/reverse rotation speed limits.	
		Rotation direction command inputs	When setup parameter Cn-02 bit no. 2 = 1, this is the rotation direction command for internal speed settings 1 to 3.	

(This table continues on the next page.)

Terminal and Connector Functions (30 to 750 W)

Specifications Table - continued from previous page

Pin no.	Signal	Name	Function, Interface	Specified driver type: A: R88D-UA P: R88D-UP
15 (Prior page has other info on this pin no.)	MING/IPG/RDIR	Gain deceleration input	When setup parameter Cn-02 bit no. 2 = 0 and setup parameter Cn-01 bit no. F = 0 then, when this bit is ON, speed loop gain decreases.	P
		Pulse prohibit	When setup parameter Cn-02 bit no. 2 = 0 and setup parameter Cn-01 bit no. F = 1 then, when this bit is ON, input command pulse is prohibited.	
		Rotation direction command input	When setup parameter Cn-02 bit no. 2 = 1, this is the rotation direction command for internal speed settings 1 to 3.	
16	POT	Forward drive prohibit input	Forward rotation overtravel input (OFF when prohibited). When setup parameter Cn-01 bit no. 2 = 1, this signal is not used.	A/P
17	NOT	Reverse drive prohibit input	Reverse rotation overtravel input (OFF when prohibited). When setup parameter Cn-01 bit no. 3 = 1, this signal is not used.	A/P
18	RESET	Alarm reset input	ON: Servo alarm status is reset.	A/P
28	-	-	Do not connect	-
29	-	-		

Note: Those input specifications which are not recorded in the above table are 5 mA for 24 V power supply input.

■ CN1: Control Output (Analog Input/Pulse Train Input)

Pin no.	Signal	Name	Function, Interface	Specified driver type: A: R88D-UA P: R88D-UP
7	BKIR	Brake interlock output	Outputs external brake interlock signal. (See Note.)	A/P
8	VCMP	Speed conformity output	Output when the Servomotor rotation speed conforms to the speed command. (See Note.)	A
	INP	Positioning completed output	Turned ON when the pulse count remaining in the deviation counter is equal to or less than the positioning completed range set in user parameter Cn-1b. (See Note.)	P
9	TGON/CLIMT	Servomotor rotation detection output	When setup parameter Cn-01 bit no. 4 = 0, this turns ON if the Servomotor rotation speed exceeds the value set for the Servomotor rotation detection speed (Cn-0b). (See Note.)	A/P
		Current limit detection output	When bit 4 of setup parameter Cn-01 is set to "1," the CLIMT signal will turned ON in any of the following 3 cases: The output torque reaches the value set for the torque limit (Cn-08, -09) The forward/reverse rotation current limit (PCL/NCL) is ON and the output torque reaches the external current limit set in Cn-18 or Cn-19. When the forward/reverse rotation power supply limit is OFF, and the output torque reaches the torque limit set in Cn-08, -09. (See Note.)	
10	OGND	Output ground common	Output ground common for BKIR, VCMP, INP, TGON/CLIMT	A/P
19	EGND	Encoder signal output GND	This is the ground for encoder signal outputs.	A/P
20	+A	Encoder + A-phase input	Outputs encoder pulses divided according to user parameter Cn-0A. Line driver output (conforming to RS-422A).	A/P
21	-A	Encoder - A-phase input		

(This table continues on the next page.)

Terminal and Connector Functions (30 to 750 W)

Specifications Table - continued from previous page

Pin no.	Signal	Name	Function, Interface	Specified driver type: A: R88D-UA P: R88D-UP
22	-B	Encoder - B-phase input	Outputs encoder pulses divided according to user parameter Cn-0A. Line driver output (conforming to RS-422A).	A/P
23	+B	Encoder + B-phase input		
24	+Z	Encoder + Z-phase input	Encoder Z-phase output (1 pulse/revolution). Line driver output (conforming to RS-422A).	A/P
25	-Z	Encoder + Z-phase input		
26	-	-	Do not connect.	-
27	-	-		
30	ALO1	Alarm code output 1	When an alarm is generated for the Servo Driver, the contents of the alarm are output in code. Open collector output: 30 VDC, 20 mA max.	A/P
31	ALO2	Alarm code output 2	When an alarm is generated for the Servo Driver, the contents of the alarm are output in code. Open collector output: 30 VDC, 20 mA max.	A/P
32	ALO3	Alarm code output 3	When an alarm is generated for the Servo Driver, the contents of the alarm are output in code. Open collector output: 30 VDC, 20 mA max.	A/P
33	ALOCOM	Alarm code output GND	When an alarm is generated for the Servo Driver, the contents of the alarm are output in code. Open collector output: 30 VDC, 20 mA max.	A/P
34	ALM	Alarm output	When an alarm is generated for the Servo Driver, the output is OFF. Open collector output. (See Note.)	A/P
35	ALMCOM	Alarm output GND		A/P
36	FG	Frame ground	Ground terminal for shield wire of cable and FG line.	A/P

Note: These functions are open collector output 30 V/50 mA maximum.

Special Cables

■ R88A-CRU□□□C Encoder Cables

For connection between a U-series AC Servomotor Encoder Connector and a Servo Driver.

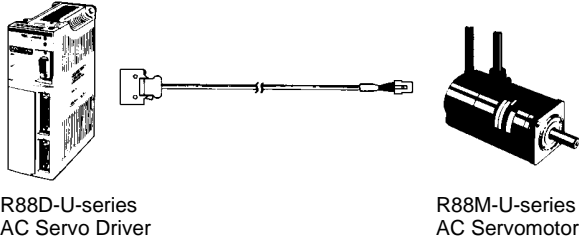

R88D-U-series
AC Servo Driver

R88M-U-series
AC Servomotor

Model	Specifications
R88A-CRU□□□C	For a Servomotor with 30- to 750-W incremental encoder attached.

Note: The three blank squares in the model number are for the cable length. The length will be 3, 5, 10, 15 or 20 m. For example, for a 3-m cable it would be: R88A-CRU003C.

■ R88A-CAU□□□□ Power Cables

For connection between a U-series Servomotor Power Connector and a Servo Driver.

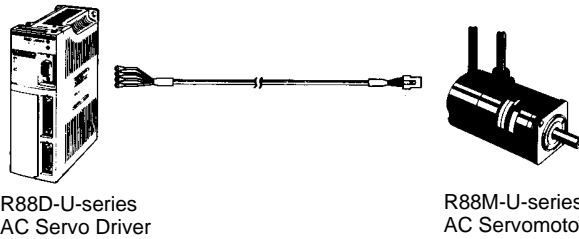

R88D-U-series
AC Servo Driver

R88M-U-series
AC Servomotor

Model	Specifications
R88A-CAU□□□S	For a Servomotor without brakes with 30 to 750 W capabilities.
R88A-CAU□□□B	For a Servomotor with brakes with 30 to 750 W capabilities.

Note: The three blank squares in the model number are for the cable length. The length will be 3, 5, 10, 15 or 20 m. For example, for a 3-m cable it would be: R88A-CAU003S.

■ R88A-CNU□□□ Connector for the Control Cable

Since the Connector for the Control Cable is not attached, be sure to purchase a connector kit, use a special control cable, or use a general-purpose control cable.

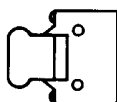

Sumitomo 3M

Model	Specifications
R88A-CNU01C	For a 30- to 750-W Servo Driver (Half-pitch 36P)

■ R88A-CPU□□□M□ Connecting Cables for a CV500-MC221/421 C200H-MC221 Motion Control Unit

For connection between the Motion Control Unit and U-series AC Servomotor.

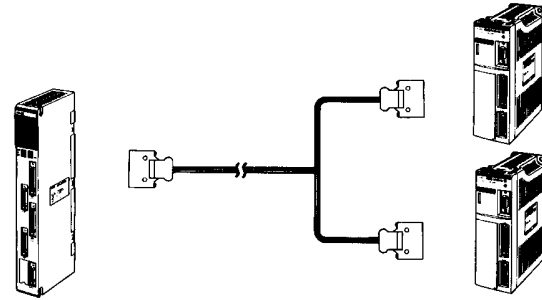

CV500-MC221/421
C200H-MC221
Motion Control Unit

R88D-U-series
AC Servo Driver

Model	Specifications	
R88A-CPU□□□M1	For 1 axis	For a 30- to 750-W Servo Driver.
R88A-CPU□□□M2	For 2 axes	For a 30- to 750-W Servo Driver.

Note: The three blank squares in the model number are for the cable length. The length will be 1 or 2 m. For example, for a 1-m cable it would be: R88A-CPU001M1.

■ R88A-CPU□□□S General-purpose Control Cable

For connection between a SYSMAC Position Control Unit or a general controller and a U-series AC Servo Driver.

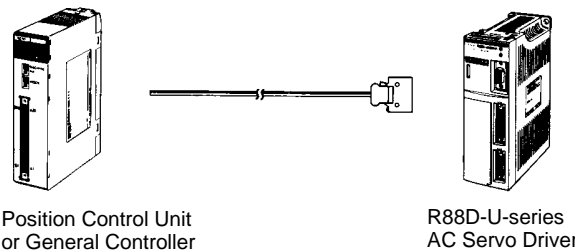

Position Control Unit
or General Controller

R88D-U-series
AC Servo Driver

Model	Specifications
R88A-CPU□□□S	For a 30 to 750 W Servo Driver.

Note: The three blank squares in the model number are for the cable length. The length will be 1 or 2 m. For example, for a 1-m cable it would be: R88A-CPU001S.

Model Number Legend

■ AC Servomotors

R88M-U10030H□-□□□

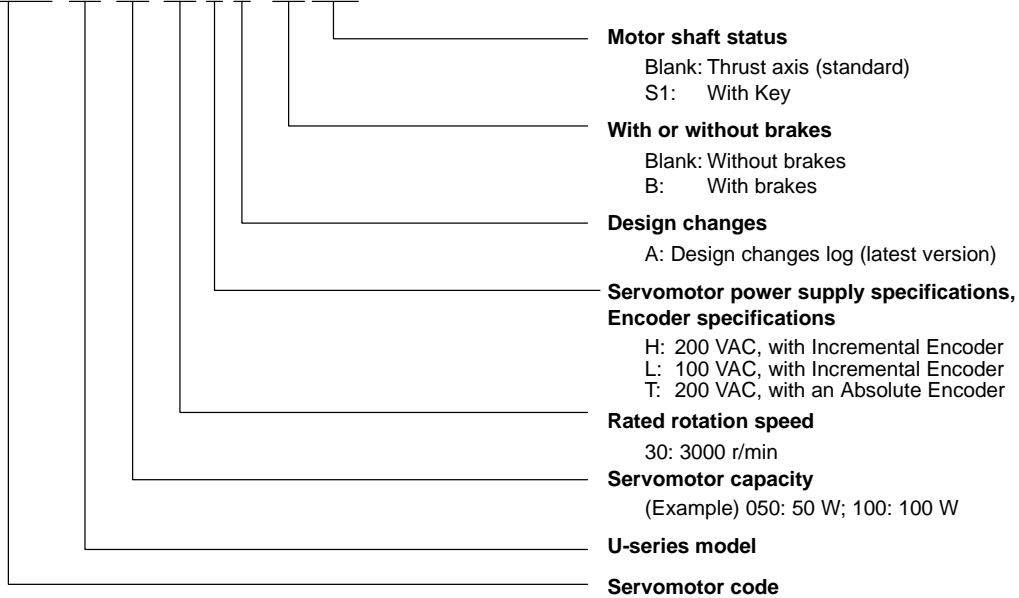

■ AC Servo Drivers

R88D-UA02H□

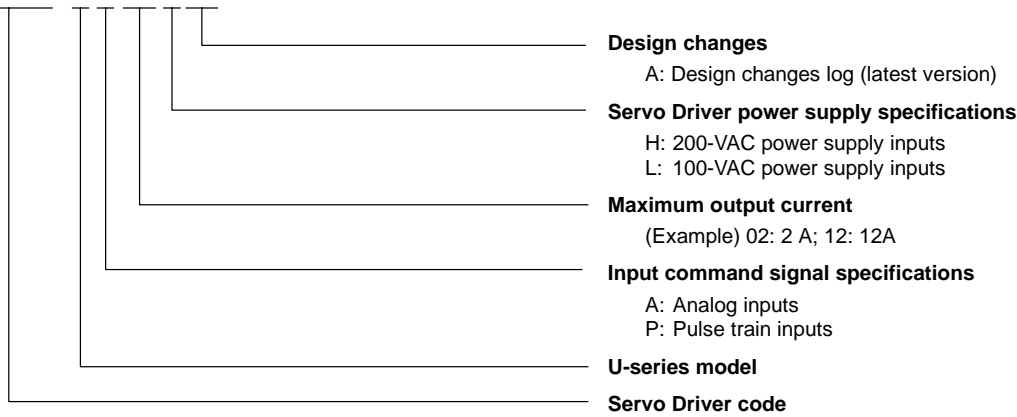

Standard Models

■ AC Servomotor (Incremental Encoder Attached)

Specifications			Model			
Straight axis with no key	Servomotor without brakes	For 200 VAC	30 W	R88M-U03030HA		
			50 W	R88M-U05030HA		
			100 W	R88M-U10030HA		
			200 W	R88M-U20030HA		
			400 W	R88M-U40030HA		
			750 W	R88M-U75030HA		
		For 100 VAC	30 W	R88M-U03030LA		
			50 W	R88M-U05030LA		
			100 W	R88M-U10030LA		
			200 W	R88M-U20030LA		
			300 W	R88M-U30030LA		
			Servomotor with brakes	For 200 VAC	30 W	R88M-U03030HA-B
		50 W			R88M-U05030HA-B	
		100 W			R88M-U10030HA-B	
200 W	R88M-U20030HA-B					
400 W	R88M-U40030HA-B					
750 W	R88M-U75030HA-B					
For 100 VAC	30 W	R88M-U03030LA-B				
	50 W	R88M-U05030LA-B				
	100 W	R88M-U10030LA-B				
	200 W	R88M-U20030LA-B				
	300 W	R88M-U30030LA-B				
	Straight axis with key	Servomotor without brakes		For 200 VAC	30 W	R88M-U03030HA-S1
					50 W	R88M-U05030HA-S1
					100 W	R88M-U10030HA-S1
200 W			R88M-U20030HA-S1			
400 W			R88M-U40030HA-S1			
750 W			R88M-U75030HA-S1			
For 100 VAC			30 W	R88M-U03030LA-S1		
			50 W	R88M-U05030LA-S1		
			100 W	R88M-U10030LA-S1		
			200 W	R88M-U20030LA-S1		
			300 W	R88M-U30030LA-S1		
			Servomotor with brakes	For 200 VAC	30 W	R88M-U03030HA-BS1
					50 W	R88M-U05030HA-BS1
					100 W	R88M-U10030HA-BS1
200 W	R88M-U20030HA-BS1					
400 W	R88M-U40030HA-BS1					
750 W	R88M-U75030HA-BS1					
For 100 VAC	30 W	R88M-U03030LA-BS1				
	50 W	R88M-U05030LA-BS1				
	100 W	R88M-U10030LA-BS1				
	200 W	R88M-U20030LA-BS1				
	300 W	R88M-U30030LA-BS1				

■ AC Servo Driver

Specifications			Model	
Analog Input Models (Incremental Encoder)	For 200 VAC	30 W	R88D-UA02HA	
		50 W	R88D-UA03HA	
		100 W	R88D-UA04HA	
		200 W	R88D-UA08HA	
		400 W	R88D-UA12HA	
		750 W	R88D-UA20HA	
	For 100 VAC	30 W	R88D-UA03LA	
		50 W	R88D-UA04LA	
		100 W	R88D-UA10LA	
		200 W	R88D-UA12LA	
		300 W	R88D-UA15LA	
		Pulse Train Input Models (Incremental Encoder)	For 200 VAC	30 W
50 W	R88D-UP03HA			
100 W	R88D-UP04HA			
200 W	R88D-UP08HA			
400 W	R88D-UP12HA			
750 W	R88D-UP20HA			
For 100 VAC	30 W		R88D-UP03LA	
	50 W		R88D-UP04LA	
	100 W		R88D-UP10LA	
	200 W		R88D-UP12LA	
	300 W		R88D-UP15LA	

■ AC Servomotor (Absolute Encoder Attached)

Specifications			Model	
Straight axis with no key	Servomotor without brakes	For 200 VAC	30 W	R88M-U03030TA
			50 W	R88M-U05030TA
			100 W	R88M-U10030TA
			200 W	R88M-U20030TA
			400 W	R88M-U40030TA
			750 W	R88M-U75030TA
			Servomotor with brakes	For 200 VAC
	50 W	R88M-U05030TA-B		
	100 W	R88M-U10030TA-B		
	200 W	R88M-U20030TA-B		
	400 W	R88M-U40030TA-B		
	750 W	R88M-U75030TA-B		

Standard Models

Parameter Units

Specifications	Model
Hand-held type	R88A-PR02U
Mounted type	R88A-PR03U

Regeneration Unit

Specifications	Model
Regeneration processing current 8 A _{DC}	R88A-RG08UA

Encoder Cables

Specifications		Model	
For 30 to 750 W	For Servomotors with an Incremental Encoder (Connectors on each side)	3 m	R88A-CRU003C
		5 m	R88A-CRU005C
		10 m	R88A-CRU010C
		15 m	R88A-CRU015C
		20 m	R88A-CRU020C
	For Servomotors with an Absolute Encoder (Connectors on each side)	3 m	R88A-CSU003C
		5 m	R88A-CSU005C
		10 m	R88A-CSU010C
		15 m	R88A-CSU015C
		20 m	R88A-CSU020C

Power Cables

Specifications		Model	
For 30 to 750 W	For Servomotors without brakes	3 m	R88A-CAU003S
		5 m	R88A-CAU005S
		10 m	R88A-CAU010S
		15 m	R88A-CAU015S
		20 m	R88A-CAU020S
	For Servomotors with brakes	3 m	R88A-CAU003B
		5 m	R88A-CAU005B
		10 m	R88A-CAU010B
		15 m	R88A-CAU015B
		20 m	R88A-CAU020B

Special Control Cables

Specifications		Model		
For 30 to 750 W	For the CV500-MC221/ CV500-MC421/ C200H-MC221 Motion Control Unit (Connectors on each side)	For 1 axes	1 m	R88A-CPU001M1
			2 m	R88A-CPU002M1
		For 2 axes	1 m	R88A-CPU001M2
			2 m	R88A-CPU002M2

General-purpose Control Cables

Specifications		Model	
For 30 to 750 W	For a general-purpose controller (Connector on one side)	1 m	R88A-CPU001S
		2 m	R88A-CPU002S

Connector for the Control Cable

Specifications	Model
For 30 to 750 W (Sumitomo 3M: Half pitch 36P)	R88A-CNU01C

Connectors and Terminal Blocks (30- to 750-W Servo Drivers)

Specifications		Model
Terminal Block Connector		XW2B-40F5-P
Conversion Cables for Connector-Terminal Conversion Unit	1 m	R88A-CTU001N
	2 m	R88A-CTU002N

Front Panel Mounting Brackets (30- to 750-W Servo Drivers)

Specifications		Model
200 VAC: 30 to 400 W 100 VAC: 30 to 200 W	For Servo Drivers	R88A-TK01U
200 VAC: 750 W 100 VAC: 300 W	For Servo Drivers	R88A-TK02U

Note: For information on any products which are not listed here, contact your local sales office.

Important Information

NOTICE

Before using the product under the conditions listed below, consult your OMRON representative; make sure that the ratings and performance characteristics of the product are appropriate for the systems machines, or equipment; and, ensure that you have provided the systems, machines, or equipment with double safety mechanisms.

1. Applications under conditions or environments not specified in the manual.
2. Applications for nuclear reactor control, train facilities, aviation facilities, motorized vehicles, furnaces, medical equipment, amusement equipment, and safety equipment.
3. Applications strongly related to human life or property, particularly those requiring safety.

ATTENTION

You must read the relevant user's manuals carefully before attempting to operate any of the equipment described in this catalog.

NOTE: DIMENSIONS SHOWN ARE IN MILLIMETERS. To convert millimeters to inches divide by 25.4.

OMRON[®]

OMRON ELECTRONICS, INC.

One East Commerce Drive
Schaumburg, IL 60173

1-800-55-OMRON

OMRON CANADA, INC.

885 Milner Avenue
Scarborough, Ontario M1B 5V8

416-286-6465