

Excellent Integrated System Limited

Stocking Distributor

Click to view price, real time Inventory, Delivery & Lifecycle Information:

[Phoenix Contact](#)
[1725672](#)

For any questions, you can email us directly:

sales@integrated-circuit.com



Extract from the online catalog

MPT 0,5/ 4-2,54

Order No.: 1725672

The figure shows a 10-position version of the product



<http://eshop.phoenixcontact.de/phoenix/treeViewClick.do?UID=1725672>

PC terminal block, Nominal current: 6 A, Nom. voltage: 63 V, Pitch: 2.54 mm, Number of positions: 4, Type of connection: Screw connection, Assembly: Soldering, Conductor/PCB connection direction: 0 °, Color: green

Commercial data	
EAN	4017918116279
Pack	50 pcs.
Customs tariff	85369010
Weight/Piece	0.001265 KG
Catalog page information	Page 51 (CC-2009)

Product notes

WEEE/RoHS-compliant since:
01/01/2003



<http://www.download.phoenixcontact.com>
Please note that the data given here has been taken from the online catalog. For comprehensive information and data, please refer to the user documentation. The General Terms and Conditions of Use apply to Internet downloads.

Technical data

Dimensions / positions	
Length	6.2 mm
Pitch	2.54 mm
Dimension a	7.62 mm

MPT 0,5/ 4-2,54 Order No.: 1725672

<http://eshop.phoenixcontact.de/phoenix/treeViewClick.do?UID=1725672>

Number of positions	4
Pin dimensions	0,5 x 0,9 mm
Hole diameter	1.1 mm
Screw thread	M1,6
Tightening torque, min	0.12 Nm
Tightening torque max	0.15 Nm

Technical data

Insulating material group	I
Rated surge voltage (III/3)	1.5 kV
Rated surge voltage (III/2)	1.5 kV
Rated surge voltage (II/2)	2.5 kV
Rated voltage (III/2)	160 V
Rated voltage (II/2)	320 V
Connection in acc. with standard	EN-VDE
Nominal current I_N	6 A
Nominal voltage U_N	63 V
Nominal cross section	0.5 mm ²
Maximum load current	6 A
Insulating material	PA
Inflammability class acc. to UL 94	V0
Stripping length	4.5 mm

Connection data

Conductor cross section solid min.	0.14 mm ²
Conductor cross section solid max.	0.5 mm ²
Conductor cross section stranded min.	0.14 mm ²
Conductor cross section stranded max.	0.5 mm ²
Conductor cross section stranded, with ferrule without plastic sleeve min.	0.25 mm ²
Conductor cross section stranded, with ferrule without plastic sleeve max.	0.34 mm ²
Conductor cross section stranded, with ferrule with plastic sleeve min.	0.25 mm ²
Conductor cross section stranded, with ferrule with plastic sleeve max.	0.34 mm ²
Conductor cross section AWG/kcmil min.	26
Conductor cross section AWG/kcmil max	20

MPT 0,5/ 4-2,54 Order No.: 1725672

<http://eshop.phoenixcontact.de/phoenix/treeViewClick.do?UID=1725672>

2 conductors with same cross section, solid min.	0.14 mm ²
2 conductors with same cross section, solid max.	0.34 mm ²
2 conductors with same cross section, stranded min.	0.14 mm ²
2 conductors with same cross section, stranded max.	0.34 mm ²

Certificates / Approvals



Certification CSA, CUL, UL

CSA

Nominal voltage U _N	125 V
Nominal current I _N	6 A
AWG/kcmil	28-20

CUL

Nominal voltage U _N	125 V
Nominal current I _N	6 A
AWG/kcmil	30-20

UL

Nominal voltage U _N	125 V
Nominal current I _N	6 A
AWG/kcmil	30-20

Accessories

Item	Designation	Description
Marking		
0804853	SK 2,54/2,8:FORTL.ZAHLEN	Marker card, printed horizontally, self-adhesive, 10-section marker strip, 14 identical decades marked 1-10, 11-20 etc. up to 91-100, sufficient for 140 terminal blocks
Tools		
1205202	SZS 0,4X2,0	Screwdriver, bladed, matches all screw terminal blocks up to 1.5 mm ² connection cross section, blade width: 2.5 mm, without approvals

MPT 0,5/ 4-2,54 Order No.: 1725672

<http://eshop.phoenixcontact.de/phoenix/treeViewClick.do?UID=1725672>

Diagrams/Drawings

Drilling plan/solder pad geometry

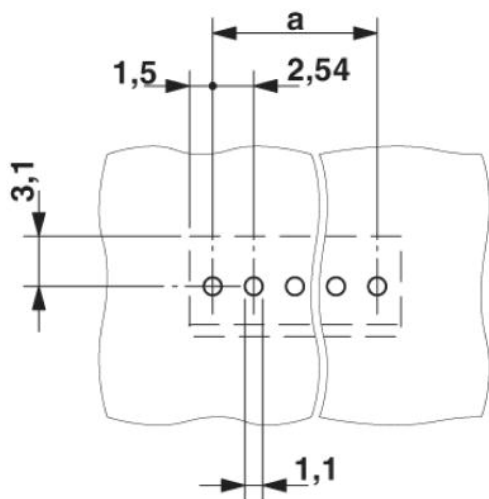

Dimensioned drawing

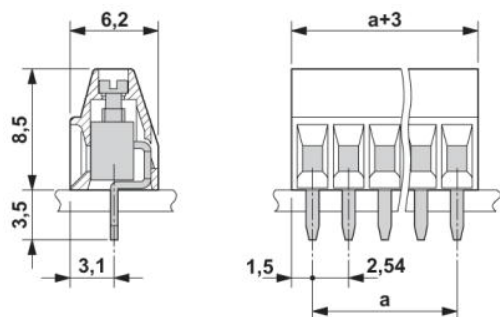

MPT 0,5/ 4-2,54 Order No.: 1725672

<http://eshop.phoenixcontact.de/phoenix/treeViewClick.do?UID=1725672>

Address

PHOENIX CONTACT Deutschland GmbH
Flachsmarktstr. 8
32825 Blomberg, Germany
Phone +49 5235 3 12000
Fax +49 5235 3 41200
<http://www.phoenixcontact.de>



© 2010 Phoenix Contact
Technical modifications reserved;