



Distributor of Molex Connector Corporation: Excellent Integrated System Limited
Datasheet of 87264-1850 - Connector Receptacle 18 Position 0.079" (2.00mm) Gold Through
Hole, Right Angle

Contact us: sales@integrated-circuit.com Website: www.integrated-circuit.com

Excellent Integrated System Limited

Stocking Distributor

Click to view price, real time Inventory, Delivery & Lifecycle Information:

[Molex Connector Corporation](#)
[87264-1850](#)

For any questions, you can email us directly:
sales@integrated-circuit.com

Contact us: sales@integrated-circuit.com Website: www.integrated-circuit.com

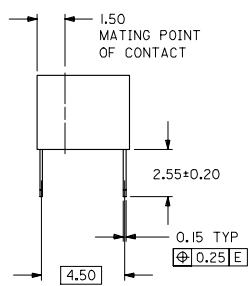
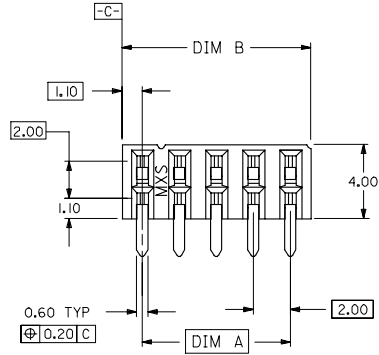

PART NO. LEGEND

87264- * * 5 *
CIRCUIT SIZE PLATING
POST-PLATED

- 0 - 0.38um/15uin MIN. GOLD PLATE IN SELECTED AREA AND 2.54um/100uin MIN. TIN/LEAD IN SELECTED AREA OVER 1.27um/50uin NICKEL OVERALL (IN TUBE).
- 1 - 0.76um/30uin MIN. GOLD PLATE IN SELECTED AREA AND 1.90um/75uin MIN. TIN/LEAD IN SELECTED AREA OVER 1.27um/50uin NICKEL OVERALL (IN TUBE).
- 2 - 0.38um/15uin MIN. GOLD PLATE IN SELECTED AREA AND 2.54um/100uin MIN. TIN IN SELECTED AREA OVER 1.27um/50uin NICKEL OVERALL (IN TUBE).
- 3 - 0.76um/30uin MIN. GOLD PLATE IN SELECTED AREA AND 2.54um/100uin MIN. TIN IN SELECTED AREA OVER 1.27um/50uin NICKEL OVERALL (IN TUBE).
- 6 - 0.38um/15uin MIN. GOLD PLATE IN SELECTED AREA AND 2.54um/100uin MIN. TIN/LEAD IN SELECTED AREA OVER 1.27um/50uin NICKEL OVERALL. (IN TAPE/REEL)
- 7 - 0.76um/30uin MIN. GOLD PLATE IN SELECTED AREA AND 2.54um/100uin MIN. TIN/LEAD IN SELECTED AREA OVER 1.27um/50uin NICKEL OVERALL. (IN TAPE/REEL)
- 8 - 0.38um/15uin MIN. GOLD PLATE IN SELECTED AREA AND 2.54um/100uin MIN. TIN IN SELECTED AREA OVER 1.27um/50uin NICKEL OVERALL. (IN TAPE/REEL)
- 9 - 0.76um/30uin MIN. GOLD PLATE IN SELECTED AREA AND 2.54um/100uin MIN. TIN IN SELECTED AREA OVER 1.27um/50uin NICKEL OVERALL. (IN TAPE/REEL)

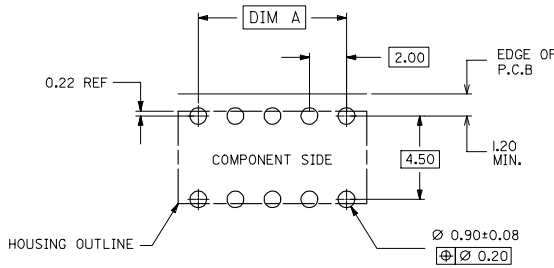
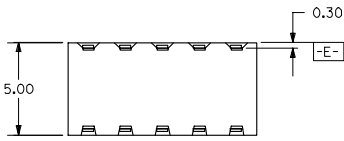

RECOMMENDED P.C. BOARD LAYOUT

NOTES:

1. IO CIRCUIT SIZE SHOWN FOR ILLUSTRATION ONLY. SEE CHART FOR AVAILABLE PART SIZES.
2. PLATING FINISH : TERMINAL - AS PER LEGEND
3. RECOMMENDED PC BOARD THICKNESS IS 1.60 +/- 0.10mm.
4. PRODUCT SPECIFICATION PS-87264 APPLIES.
5. PART IS MATEABLE TO ALL MILLI-GRID HEADERS WITH MATING PIN LENGTH BETWEEN 2.50mm AND 4.20mm.
6. TAPE & REEL OPTION IS SHOWN ON SHT 3 WITH 8 CKT ILLUSTRATION.

UPDATE REVISION EC NO: S2005-0714 DRAWN/SEEK CHKD/BLOW APPR/PJLIM 2005/10/19 2005/11/05 D2	QUALITY SYMBOLS ▽=0 ▽=0	GENERAL TOLERANCES (UNLESS SPECIFIED)		DIMENSION STYLE MM ONLY		SCALE NTS	DESIGN UNITS METRIC	THIRD ANGLE PROJECTION		
		4 PLACES ± --- ± ---	3 PLACES ± --- ± ---	2 PLACES ± 0.2 ± ---	1 PLACE ± --- ± ---	DRAWN BY JWAN	DATE 1992/02/25	TITLE SALES DRAWING MGRID, 2MM DUAL ROW HDR. SIDE ENTRY RECEPT., T/H		
		ANGULAR ± 3 °		DRAFT WHERE APPLICABLE MUST REMAIN WITHIN DIMENSIONS		APPROVED BY RWONG	DATE 1992/02/25	MOLEX INCORPORATED		
		MATERIAL NO. SEE TABLE		DOCUMENT NO. SD-87264-**-50		SHEET NO. 1 OF 3		THIS DRAWING CONTAINS INFORMATION THAT IS PROPRIETARY TO MOLEX INCORPORATED AND SHOULD NOT BE USED WITHOUT WRITTEN PERMISSION		

Contact us: sales@integrated-circuit.com Website: www.integrated-circuit.com

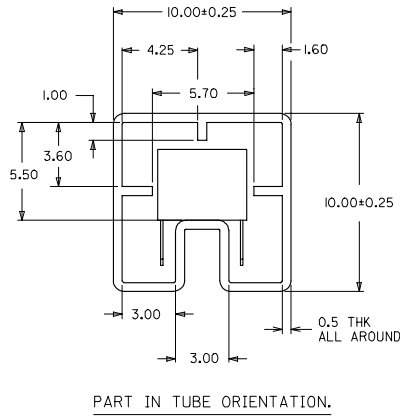
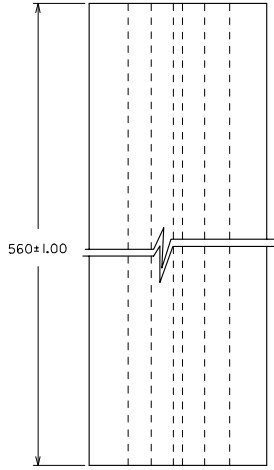

PART NUMBER 0.38um GOLD PLATING \triangle_2	PART NUMBER 0.76um GOLD PLATING \triangle_2	CKT. SIZE	DIM A	DIM B
87264-065*	87264-065*	6	4.00	6.20
87264-085*	87264-085*	8	6.00	8.20
87264-105*	87264-105*	10	8.00	10.20
87264-125*	87264-125*	12	10.00	12.20
87264-145*	87264-145*	14	12.00	14.20
87264-165*	87264-165*	16	14.00	16.20
87264-185*	87264-185*	18	16.00	18.20
87264-205*	87264-205*	20	18.00	20.20
87264-225*	87264-225*	22	20.00	22.20
87264-245*	87264-245*	24	22.00	24.20
87264-265*	87264-265*	26	24.00	26.20
87264-285*	87264-285*	28	26.00	28.20
87264-305*	87264-305*	30	28.00	30.20
87264-325*	87264-325*	32	30.00	32.20
87264-345*	87264-345*	34	32.00	34.20
87264-365*	87264-365*	36	34.00	36.20
87264-385*	87264-385*	38	36.00	38.20
87264-405*	87264-405*	40	38.00	40.20
87264-425*	87264-425*	42	40.00	42.20
87264-445*	87264-445*	44	42.00	44.20
87264-465*	87264-465*	46	44.00	46.20
87264-485*	87264-485*	48	46.00	48.20
87264-505*	87264-505*	50	48.00	50.20

UPDATE REVISION EC NO: S2005-0714 DRAWN/SEE CHKD/BLOW APPR/PLM D2	2005/10/19 2005/10/19 2005/11/05	QUALITY SYMBOLS $\nabla=0$ $\nabla=0$	GENERAL TOLERANCES (UNLESS SPECIFIED)		DIMENSION STYLE MM ONLY		SCALE NTS	DESIGN UNITS METRIC	THIRD ANGLE PROJECTION		
			4 PLACES	± ---	± ---	DRAWN BY JWAN	DATE 1992/02/25	TITLE SALES DRAWING MGRID, 2MM DUAL ROW HDR. SIDE ENTRY RECEPT., T/H			
			3 PLACES	± ---	± ---	CHECKED BY MLAI	DATE 1992/02/25	MATERIAL NO. SEE TABLE			
			2 PLACES	± 0.2	± ---	APPROVED BY RWONG	DATE 1992/02/25	DOCUMENT NO. SD-87264-**-50			
		1 PLACE	± ---	± ---	ANGULAR ± 3 °		SHEET NO. 2 OF 3		THIS DRAWING CONTAINS INFORMATION THAT IS PROPRIETARY TO MOLEX INCORPORATED AND SHOULD NOT BE USED WITHOUT WRITTEN PERMISSION		

Contact us: sales@integrated-circuit.com Website: www.integrated-circuit.com

PART NUMBER 0.38um GOLD PLATING (IN TAPE/REEL)	PART NUMBER 0.76um GOLD PLATING (IN TAPE/REEL)	CKT SIZE	DIM W	DIM F	DIM Bo
87264-085*	87264-085*	8	24.00	11.50	8.80

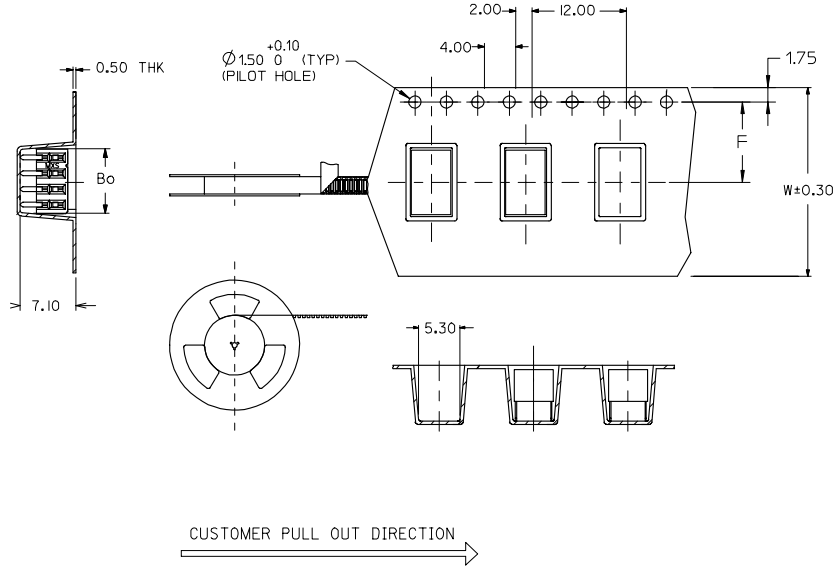

NOTES:

- LEADER AND TRAILER TAPE
- PEELING OFF FORCE OF THE TOP TAPE: 20-80gf.
 (PEELING DIRECTION AS SHOWN IN FOLLOWING FIGURE)
- PACKAGING STANDARD IS AS PER EIA-481.
- TAPE & REEL QUANTITY = 600PCS/REEL

ADD LEADER & TRAILER EC NO: S2005-0714 DRAWN/SEE: 2005/10/19 CHKD/BLOW: 2005/10/19 APPR/PJL/M: 2005/11/05 D2	QUALITY SYMBOLS	GENERAL TOLERANCES (UNLESS SPECIFIED)	DIMENSION STYLE MM ONLY	SCALE NTS	DESIGN UNITS METRIC	THIRD ANGLE PROJECTION	
	$\nabla=0$ $\nabla=0$	4 PLACES ± --- ± --- 3 PLACES ± --- ± --- 2 PLACES ± 0.2 ± --- 1 PLACE ± --- ± --- ANGULAR ± 3 °	DRAWN BY: JWAN DATE: 1992/02/25 CHECKED BY: MLAI DATE: 1992/02/25 APPROVED BY: RWONG DATE: 1992/02/25	TITLE	SALES DRAWING MGRID, 2MM DUAL ROW HDR. SIDE ENTRY RECEPT., T/H	MOLEX INCORPORATED	
	DRAFT WHERE APPLICABLE MUST REMAIN WITHIN DIMENSIONS	MATERIAL NO. SEE TABLE	DOCUMENT NO. SD-87264-**-50	SHEET NO. 3 OF 3			
	THIS DRAWING CONTAINS INFORMATION THAT IS PROPRIETARY TO MOLEX INCORPORATED AND SHOULD NOT BE USED WITHOUT WRITTEN PERMISSION						