

Excellent Integrated System Limited

Stocking Distributor

Click to view price, real time Inventory, Delivery & Lifecycle Information:

[Everlight Electronics Co Ltd](#)
[484-10UYT/S530-A3](#)

For any questions, you can email us directly:

sales@integrated-circuit.com



Technical Data Sheet
 3.0mm Very Wide Angle Type LED Lamps

484-10UYT/S530-A3

■ Features :

- Choice of various viewing angles
- Available on tape and reel.
- Reliable and robust
- Pb free
- The product itself will remain within RoHS compliant version.



■ Descriptions :

- The series is specially designed for applications requiring higher brightness
- The led lamps are available with different colors, intensities.

■ Applications :

- TV set
- Monitor
- Telephone
- Computer

| PART NO. | Material | Emitted Color | Lens Color |
|-------------------|----------|---------------|--------------|
| 484-10UYT/S530-A3 | AlGaInP | Super Yellow | Yellow Trans |



Technical Data Sheet
 3.0mm Very Wide Angle Type LED Lamps

484-10UYT/S530-A3

Package Dimensions

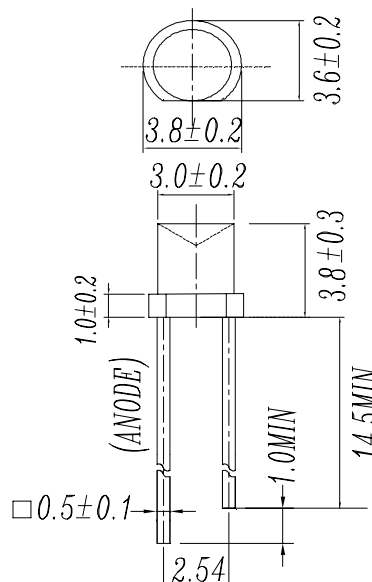

- Notes: 1. All dimensions are in millimetres
 2. The height of flange must be less than 1.5mm(0.059").
 3. Without special declared,the tolerance is±0.25mm.

Absolute Maximum Ratings at Ta = 25°C

| Parameter | Symbol | Rating | Unit |
|-------------------------|----------|-------------|------|
| Forward Current | IF | 25 | mA |
| Operating Temperature | Topr | -40 to +85 | °C |
| Storage Temperature | Tstg | -40 to +100 | °C |
| Soldering Temperature | Tsol | 260 ± 5 | °C |
| Electrostatic Discharge | ESD | 2000 | V |
| Power Dissipation | Pd | 60 | mW |
| Peak Forward Current | IF(Peak) | 60 | mA |
| Reverse Voltage | VR | 5 | V |

Note: *1:Soldering time ≤ 5 seconds.



Technical Data Sheet
 3.0mm Very Wide Angle Type LED Lamps

484-10UYT/S530-A3

Electro-Optical Characteristics (Ta=25°C)

| Parameter | Symbol | Condition | Min. | Typ. | Max. | Unit |
|------------------------------|----------------|------------------------|------|------|------|------|
| Forward Voltage | V _F | I _F = 20 mA | / | 2.0 | 2.4 | V |
| Reverse Current | I _R | V _R = 5 V | / | / | 10 | μA |
| Luminous Intensity | I _v | I _F = 20 mA | 16 | 32 | / | mcd |
| Viewing Angle | 2θ 1/2 | I _F = 20 mA | / | 110 | / | deg |
| Peak Wavelength | λ _p | I _F = 20 mA | / | 591 | / | nm |
| Dominant Wavelength | λ _d | I _F = 20 mA | / | 589 | / | nm |
| Spectrum Radiation Bandwidth | Δλ | I _F = 20 mA | / | 15 | / | nm |



Technical Data Sheet
 3.0mm Very Wide Angle Type LED Lamps

484-10UYT/S530-A3

■ Typical Electro-Optical Characteristic Curves:

(UY)

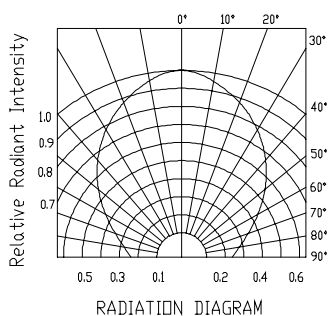
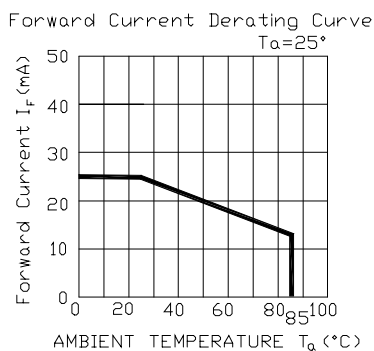
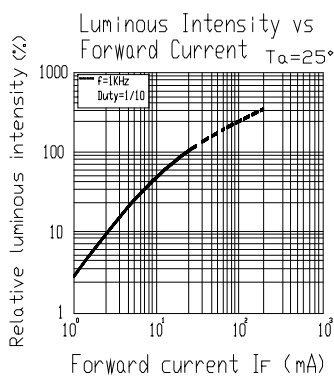
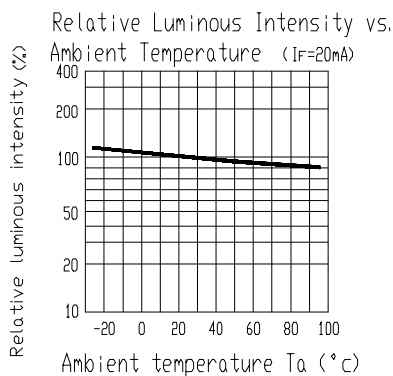
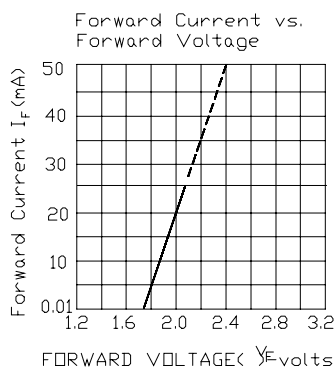
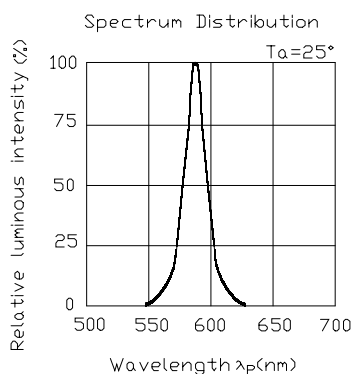



Technical Data Sheet

3.0mm Very Wide Angle Type LED Lamps

484-10UYT/S530-A3

■ Reliability test items and conditions:

The reliability of products shall be satisfied with items listed below.

Confidence level : 97%

LTPD : 3%

| NO | Item | Test Conditions | Test Hours/Cycle | Sample Size | Failure Judgment Criteria | Ac/Re |
|----|----------------------------------|---|------------------|-------------|---|-------|
| 1 | Solder Heat | TEMP : 260°C ± 5 °C | 10 SEC | 76 PCS | $I_v \leq I_{vt} * 0.5$ or $V_f \geq U$ or $V_f \leq L$ | 0/1 |
| 2 | Temperature Cycle | H : +100°C 15min \int 5 min L : -40°C 15min | 300 CYCLES | 76 PCS | | 0/1 |
| 3 | Thermal Shock | H : +100°C 5min \int 10 sec L : -10°C 5min | 300 CYCLES | 76 PCS | | 0/1 |
| 4 | High Temperature Storage | TEMP : 100°C | 1000 HRS | 76 PCS | | 0/1 |
| 5 | Low Temperature Storage | TEMP : -40°C | 1000 HRS | 76 PCS | | 0/1 |
| 6 | DC Operating Life | TEMP : 25°C $I_F = 20mA$ | 1000 HRS | 76 PCS | | 0/1 |
| 7 | High Temperature / High Humidity | 85°C / 85% RH | 1000 HRS | 76 PCS | | 0/1 |

Note : I_{vt} : To test I_v value of the chip before the reliability test

I_v : The test value of the chip that has completed the reliability test

U : Upper Specification Limit

L : Lower Specification Limit



Technical Data Sheet
 3.0mm Very Wide Angle Type LED Lamps

484-10UYT/S530-A3

Packing Quantity Specification

1.1000PCS/1Bag · 4Bags/1Box

2.10Boxes/1Carton

Label Form Specification

EVERLIGHT

CPN:

P/N:



484-10UYT/S530-A3

QTY:



CAT:

HUE:

REF:

LOT NO: EL



CPN: Customer's Production Number

P/N : Production Number

QTY: Packing Quantity

CAT: Ranks

HUE: Dominant Wavelength

REF: Reference

LOT No: Lot Number

Notes

- Above specification may be changed without notice. EVERLIGHT will reserve authority on material change for above specification.
- When using this product, please observe the absolute maximum ratings and the instructions for using outlined in these specification sheets. EVERLIGHT assumes no responsibility for any damage resulting from use of the product which does not comply with the absolute maximum ratings and the instructions included in these specification sheets.
- These specification sheets include materials protected under copyright of EVERLIGHT corporation. Please don't reproduce or cause anyone to reproduce them without EVERLIGHT's consent.

EVERLIGHT ELECTRONICS CO., LTD.

Office: No 25, Lane 76, Sec 3, Chung Yang Rd,

Tucheng, Taipei 236, Taiwan, R.O.C

Tel: 886-2-2267-2000, 2267-9936

Fax: 886-2267-6244, 2267-6189, 2267-6306

<http://www.everlight.com>