

Excellent Integrated System Limited

Stocking Distributor

Click to view price, real time Inventory, Delivery & Lifecycle Information:

[Phoenix Contact](#)
[2800500](#)

For any questions, you can email us directly:

sales@integrated-circuit.com



Extract from the online catalog

VAL-SQ SP 50-480D

Order No.: 2800500



<http://eshop.phoenixcontact.de/phoenix/treeViewClick.do?UID=2800500>

Surge protection device for 480 V AC Delta configurations. Uses a compact, NEMA rated enclosure that connects easily to an existing enclosure. Hybrid Sine Wave Tracking provides 50 kA surge protection.

Commercial data	
GTIN (EAN)	 4 046356 565080
Note	Made-to-order
sales group	J102
Pack	1 pcs.
Customs tariff	85363090
Catalog page information	Page 77 (TT-2011)

Product notes

WEEE/RoHS-compliant since:
02/21/2010



<http://www.download.phoenixcontact.com>
 Please note that the data given here has been taken from the online catalog. For comprehensive information and data, please refer to the user documentation. The General Terms and Conditions of Use apply to Internet downloads.

Product description

Surge protection device for 480 V AC Delta configurations with 50 kA protection

VAL-SQ SP 50-480D Order No.: 2800500
<http://eshop.phoenixcontact.de/phoenix/treeViewClick.do?UID=2800500>

Technical data	
Standards	
Degree of protection	NEMA 4X
Mounting type	3/4 inch NPT male
Design	Parallel hybrid
Ambient temperature (operation)	-40 °C ... 71 °C
Altitude	3658 m
Message: Surge protection fault	Phase LEDs
	Audible alarm
	Remote indicator contact
Direction of action	3L-N & N-GND
Width	250.00 mm
Height	122.00 mm
Protective circuit	
Arrester rated voltage U_c	840 V
Response time	< 1 ns
Connection, protective circuit	
Connection method	#10 AWG/5.26 mm ² wires (24 in./61 cm long)
	4-wire + Gnd
Conductor cross section AWG/kcmil min.	10
Conductor cross section AWG/kcmil max	10
Remote indicator contact	
Connection method	#24 AWG/0.205 mm ² wires (24 in./61 cm long)
NEMA / UL data	
UL type	type 2
Maximum Continuous Operating Voltage (MCOV without reference direction)	840 V
Voltage protection rating (VPR L-L)	3000 V
Nominal discharge current I_n (without reference direction)	20 kA
Maximum Surge Current per Phase	50 kA
Short-circuit current rating (SCCR)	200 kA
EMI/RFI filtering	-30 dB @ 100 kHz

VAL-SQ SP 50-480D Order No.: 2800500

<http://eshop.phoenixcontact.de/phoenix/treeViewClick.do?UID=2800500>

Environmental conditions

Standards/regulations	UL 1449 3 rd edition, Sept. 2009
	UL 1283
	IEEE C62.41
	IEEE C62.45

Diagrams/Drawings

Circuit diagram

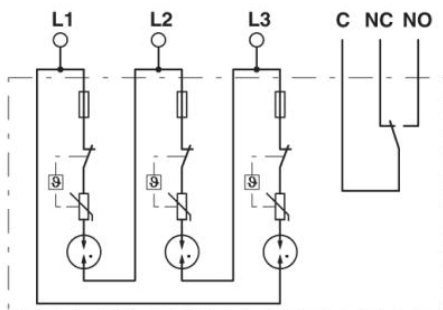

VAL-SQ SP 50-480D Order No.: 2800500

<http://eshop.phoenixcontact.de/phoenix/treeViewClick.do?UID=2800500>

Address

PHOENIX CONTACT Inc., USA
586 Fulling Mill Road
Middletown, PA 17057, USA
Phone (800) 888-7388
Fax (717) 944-1625
<http://www.phoenixcon.com>



© 2011 Phoenix Contact
Technical modifications reserved;